

Common mode filters/Chokes
Automotive signal line (for power train/safety)
ACT series



AEC-Q200

ACT1210L-101 type



FEATURES

- Common mode choke for automotive A²B (Audiobus) C²B (Car camera bus) , compatible with an operating temperature range of -40 to +125°C.
- By unique method, maintenance and L high 100μH is a product which realized high Characterization of mode conversion characteristics Scd21.
- Operating temperature range: -40 to +125°C (including self-temperature rise)
- Compliant with AEC-Q200

APPLICATION

- A²B system
- C²B system

PART NUMBER CONSTRUCTION

ACT1210L	-	101	-	2P	-	TL		00
Series • type name		Inductance(typ.) (μH)		Number of lines		Packaging style		Internal code

CHARACTERISTICS SPECIFICATION TABLE

Common mode inductance [100kHz] (μH)	Tolerance	DC resistance (Ω)max.	Insulation resistance (MΩ)min.	Rated current (mA)max.	Rated voltage (V)max.	Part No.
100	+50/-30%	1.5	10	150	80	ACT1210L-101-2P-TL00

Measurement equipment

Measurement item	Product No.	Manufacturer
Common mode inductance	4294A	Keysight Technologies
DC resistance	4338A	Keysight Technologies
Insulation resistance	4339A	Keysight Technologies

* Equivalent measurement equipment may be used.



ACT1210L-101 type

■ IMPEDANCE VS. FREQUENCY CHARACTERISTICS

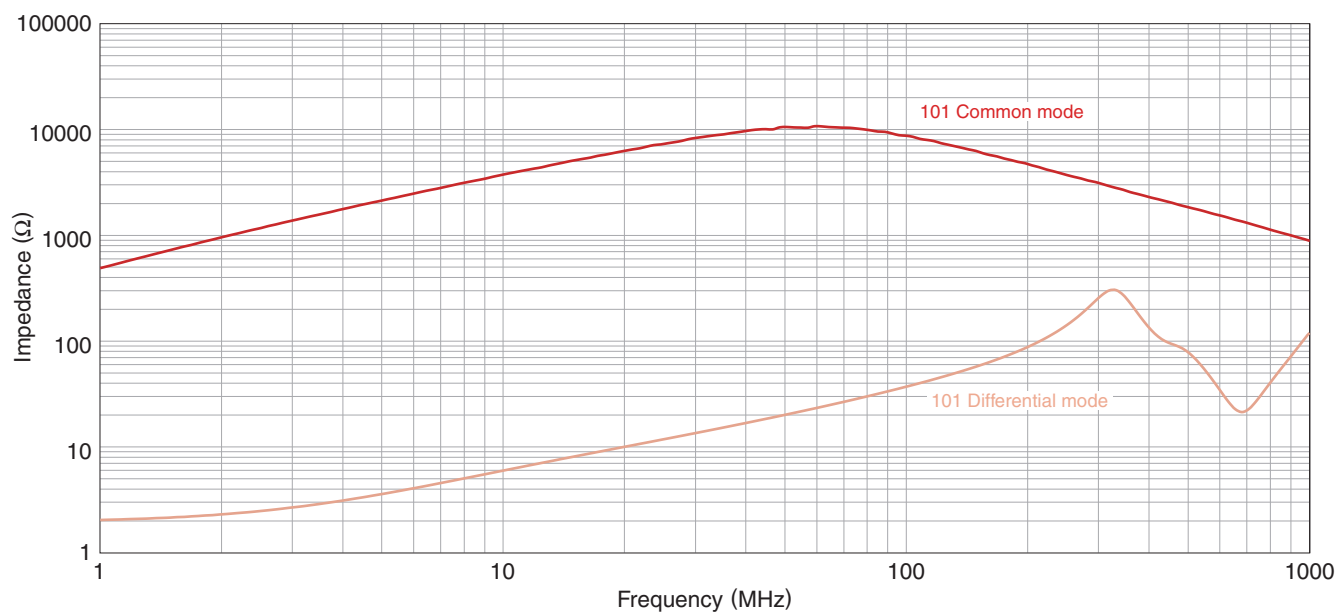

Measurement equipment

Product No.	Manufacturer
4991A	Keysight Technologies

* Equivalent measurement equipment may be used.

ACT1210L-101 type

SHAPE & DIMENSIONS

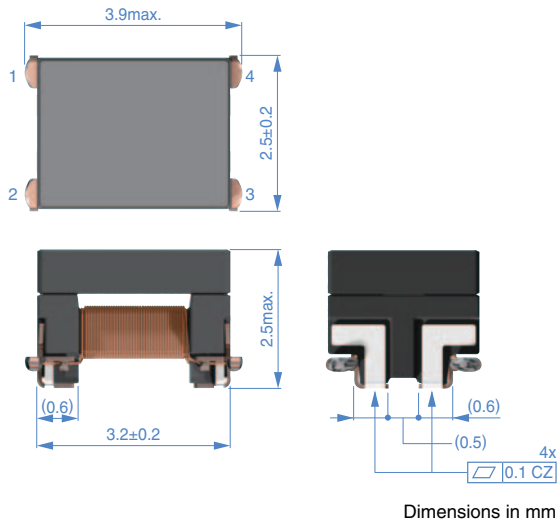

PACKAGING STYLE

REEL DIMENSIONS

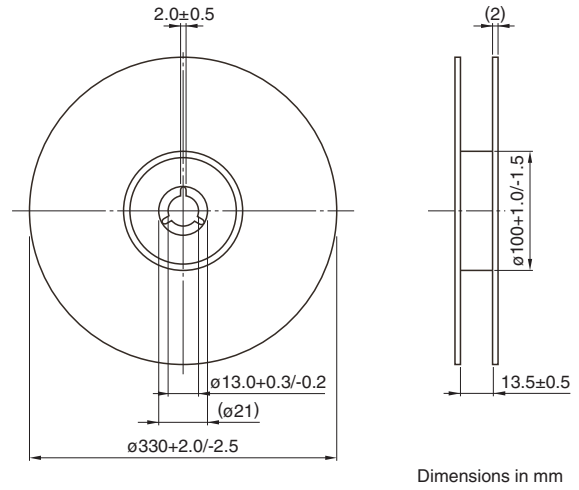

RECOMMENDED LAND PATTERN

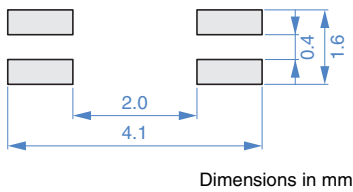

TAPE DIMENSIONS

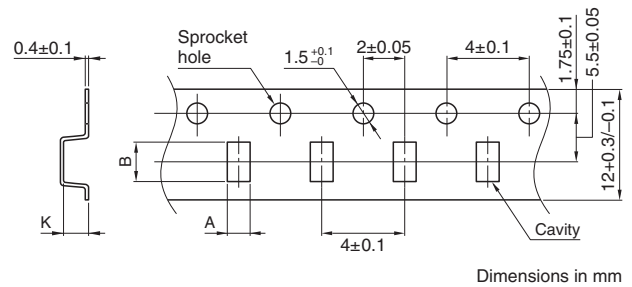

CIRCUIT DIAGRAM

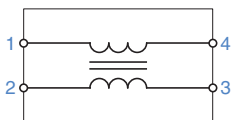

• No polarity

RECOMMENDED REFLOW PROFILE

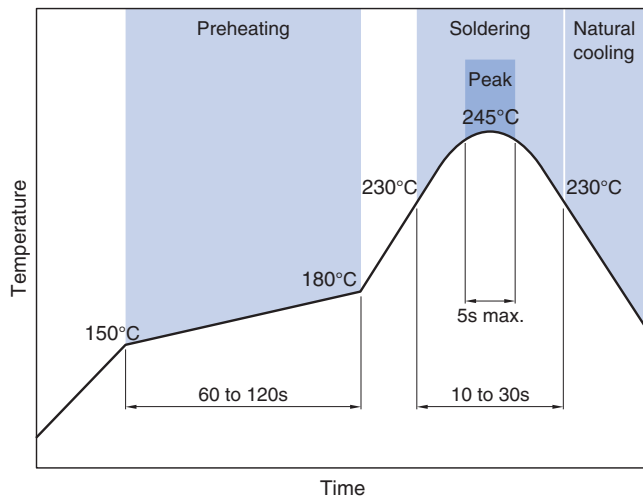

TEMPERATURE RANGE, INDIVIDUAL WEIGHT

Operating temperature range	Individual weight
-40 to +125°C	0.075 g

* The storage temperature range is for after the assembly.

Type	A	B	K
ACT1210L-101	(2.85)	(4.2)	(2.7)

PACKAGE QUANTITY

Package quantity	6,000 pcs/reel
------------------	----------------

REMINDERS FOR USING THESE PRODUCTS

Before using these products, be sure to request the delivery specifications.

SAFETY REMINDERS

Please pay sufficient attention to the warnings for safe designing when using this products.

REMINDERS

- The storage period is within 12 months. Be sure to follow the storage conditions (temperature: 5 to 40°C, humidity: 10 to 75% RH or less).
If the storage period elapses, the soldering of the terminal electrodes may deteriorate.
- Do not use or store in locations where there are conditions such as gas corrosion (salt, acid, alkali, etc.).
- Soldering corrections after mounting should be within the range of the conditions determined in the specifications.
If overheated, a short circuit, performance deterioration, or lifespan shortening may occur.
- When embedding a printed circuit board where a chip is mounted to a set, be sure that residual stress is not given to the chip due to the overall distortion of the printed circuit board and partial distortion such as at screw tightening portions.
- Self heating (temperature increase) occurs when the power is turned ON, so the tolerance should be sufficient for the set thermal design.
- Carefully lay out the coil for the circuit board design of the non-magnetic shield type.
A malfunction may occur due to magnetic interference.
- Use a wrist band to discharge static electricity in your body through the grounding wire.
- Do not expose the products to magnets or magnetic fields.
- Do not use products that have received any excessive mechanical shock such as by being dropped.
- The performance of the product may deteriorate or at the worst case open if coating materials are used, thus please assess the situation beforehand by taking this factor into consideration.
- Due to the application of mechanical stress after mounting and handling such as contact, disconnection may occur.
- Do not use for a purpose outside of the contents regulated in the delivery specifications.
- The products listed on this specification sheet (the "Products") are intended for incorporation into automobile and/or equipment to be installed in automobile on the grounds that (i) the Products are used in accordance with the conditions and scope stated in this specification sheet and (ii) said automobile and/or equipment involving the Products are used under a normal operation and use condition.
Except for said incorporation into automobile and/or equipment installed in automobile, the Products are not designed or warranted to meet the requirements of the applications listed below, whose performance and/or quality require a more stringent level of safety or reliability, or whose failure, malfunction or trouble could cause serious damage to society, person or property. Please understand that we are not responsible for any damage or liability caused by use of the Products in any of the applications listed below or for any other use exceeding the range or conditions set forth in this specification sheet. If you intend to use the Products beyond the condition and scope of this specification sheet or in any of the applications listed below, please contact with our sales office. We will separately discuss with you applicable specification suitable for your intended use:

- 1) Aerospace/Aviation equipment,
- 2) Transportation equipment (e.g. train, ship),
- 3) Medical equipment which directly endanger human life,
- 4) Power-generation control equipment,
- 5) Atomic energy-related equipment,
- 6) Seabed equipment,
- 7) Transportation control equipment (e.g. train, ship),

- 8) Public information-processing equipment,
- 9) Military equipment,
- 10) Electric heating apparatus / burning equipment,
- 11) Disaster prevention/crime prevention equipment,
- 12) Safety equipment, or
- 13) Other applications that are not considered general-purpose applications.

When designing your equipment involving the Products, you are kindly requested to take into consideration securing protection circuit/equipment or providing backup circuits, etc. in your equipment, to ensure higher safety.

As stated above, the Products are intended for incorporation into automobile and/or equipment to be installed in automobile, however, it is not prohibited to use the Products for general electronic equipment which is not required the same high level or reliability as automobile, or which is unlikely to damage its users' life, body and property or to cause extensive impact on society. Accordingly, all description in this specification sheet is applied if the Products are incorporated into general electronic equipment which is used for normal application under a normal operation and use condition.