

IEC Appliance Inlet C18, Snap-in Mounting, Front Side, Solder or Quick-connect Terminal



See below:  
[Approvals and Compliances](#)

**Description**

- Panel mount :  
 Snap-in version front side
- 1 Function :
- Appliance Inlet , Pin temperature 70 °C , Protection class II
- Solder / Quick Connect

**Other versions on request**

- Other panel thickness
- Types for enhanced glow wire test requirements acc. IEC 60695-2-12 and -13 for the use in unattended household equipment acc. IEC 60335-1

**References**

Alternative: Version in protection class I [6100-4](#); [6100-4](#)  
 Alternative: version with line filter [5120](#)

**Weblinks**

[pdf data sheet](#), [html datasheet](#), [General Product Information](#), [Approvals](#), [Distributor-Stock-Check](#), [Accessories](#), [Detailed request for product](#)

**Technical Data**

Ratings IEC	10A / 250VAC; 50Hz	Appliance inlet/-outlet	C18 acc. to IEC 60320-1,
Ratings UL/CSA	15A / 250VAC; 60Hz		UL 60320-1, CSA C22.2 no. 60320-1
Dielectric Strength	> 2kVAC between L-N (1 min/50Hz)		(for cold conditions) pin-temperature 70 °C, 10A, Protection Class II
Allowable Operation Temperature	-25 °C to 70 °C		
IP-Protection	front side IP30 acc. to IEC 60529		
Protection against electric shock	Suitable for appliances with protection class II acc. to IEC 61140		
Terminal	Solder / Quick Connect		
Panel Thickness S	Snap-in: 1/1.2/1.5/2/2.5/3 mm		
Material: Housing	Thermoplastic, black, UL 94V-0		

**Approvals and Compliances**

Detailed information on product approvals, code requirements, usage instructions and detailed test conditions can be looked up in [Details about Approvals](#)

SCHURTER products are designed for use in industrial environments. They have approvals from independent testing bodies according to national and international standards. Products with specific characteristics and requirements such as required in the automotive sector according to IATF 16949, medical technology according to ISO 13485 or in the aerospace industry can be offered exclusively with customer-specific, individual agreements by SCHURTER.

**Approvals**



The approval mark is used by the testing authorities to certify compliance with the safety requirements placed on electronic products.

Approval Reference Type: 6102

Approval Logo	Certificates	Certification Body	Description
	<a href="#">VDE Approvals</a>	VDE	Certificate Number: 40015595
	<a href="#">UL Approvals</a>	UL	UL File Number: E96454
	<a href="#">CCC Approvals</a>	CCC	CCC Certificate Number:



## Product standards

Product standards that are referenced

Organization	Design	Standard	Description
	Designed according to	IEC 60320-1	Appliance couplers for household and similar general purposes
	Designed according to	UL 60320-1	Standard for Attachment Plugs and Receptacles
	Designed according to	CSA C22.2 no. 60320-1	General Use Receptacles, Attachment Plugs, and Similar Wiring Devices







## Application standards

Application standards where the product can be used

Organization	Design	Standard	Description
	Designed for applications acc.	IEC/UL 62368-1	Audio/video, information and communication technology equipment - Part 1: Safety requirements
	Designed for applications acc.	IEC 60335-1	Safety of electrical appliances for household and similar purposes. Meets the requirements for appliances in unattended use. This includes the enhanced requirements of glow wire tests acc. to IEC 60695-2-11 or -12 & -13.

## Compliances

The product complies with following Guide Lines

Identification	Details	Initiator	Description
	<a href="#">CE declaration of conformity</a>	SCHURTER AG	The CE marking declares that the product complies with the applicable requirements laid down in the harmonisation of Community legislation on its affixing in accordance with EU Regulation 765/2008.
	<a href="#">UKCA declaration of conformity</a>	SCHURTER AG	The UKCA marking declares that the product complies with the applicable requirements laid down in the British Amendment of Regulation (EC) 765/2008.
	RoHS	SCHURTER AG	Directive RoHS 2011/65/EU, Amendment (EU) 2015/863
	China RoHS	SCHURTER AG	The law SJ / T 11363-2006 (China RoHS) has been in force since 1 March 2007. It is similar to the EU directive RoHS.
	REACH	SCHURTER AG	On 1 June 2007, Regulation (EC) No 1907/2006 on the Registration, Evaluation, Authorization and Restriction of Chemicals 1 (abbreviated as "REACH") entered into force.
	White Paper Glow wire test	SCHURTER AG	Meets the requirements of IEC 60335-1 for appliances in unattended use. This includes the enhanced requirements of glow wire tests acc. to IEC 60695-2-11 or -12 & -13.

## Dimensions [mm]

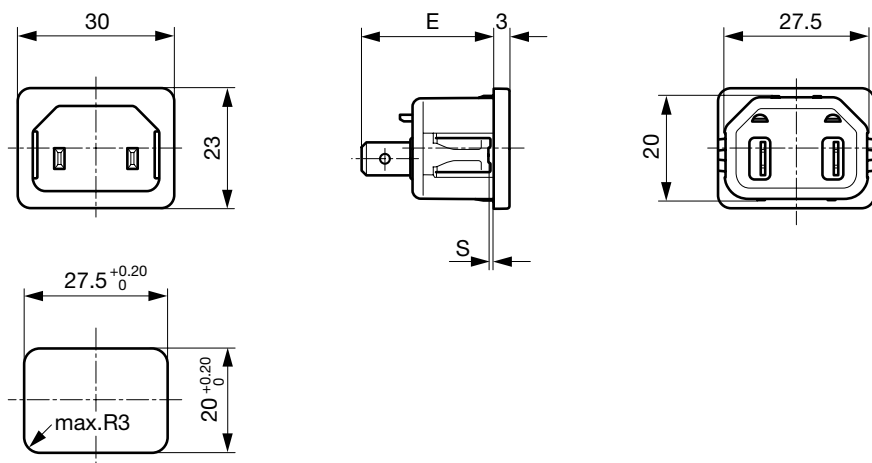

E: Solder terminals 22.5 mm

E: Quick connect terminals 25.5 mm

S: 1.0, 1.2, 1.5, 2.0, 2.5, 3.0 mm

All Variants

Type	Protection Class	Panel mounting	Panel Thickness s [mm]	Terminal	Order Number
6102-5	II	Snap-in	1.5	Quick connect terminals 4.8 x 0.8 mm	6102.5215
6102-5	II	Snap-in	2	Quick connect terminals 4.8 x 0.8 mm	6102.5220
6102-5	II	Snap-in	2.5	Quick connect terminals 4.8 x 0.8 mm	6102.5225
6102-5	II	Snap-in	3	Quick connect terminals 4.8 x 0.8 mm	6102.5230
6102-5	II	Snap-in	1	Quick connect terminals 6.3 x 0.8 mm	6102.5310
6102-5	II	Snap-in	1.2	Quick connect terminals 6.3 x 0.8 mm	6102.5312
6102-5	II	Snap-in	1.5	Quick connect terminals 6.3 x 0.8 mm	6102.5315
6102-5	II	Snap-in	2	Quick connect terminals 6.3 x 0.8 mm	6102.5320
6102-5	II	Snap-in	2.5	Quick connect terminals 6.3 x 0.8 mm	6102.5325
6102-5	II	Snap-in	3	Quick connect terminals 6.3 x 0.8 mm	6102.5330
6102-5	II	Snap-in	1	Solder terminals 3.8 x 0.8 mm	6102.5110
6102-5	II	Snap-in	1.2	Solder terminals 3.8 x 0.8 mm	6102.5112
6102-5	II	Snap-in	1.5	Solder terminals 3.8 x 0.8 mm	6102.5115
6102-5	II	Snap-in	2.5	Solder terminals 3.8 x 0.8 mm	6102.5125
6102-5	II	Snap-in	3	Solder terminals 3.8 x 0.8 mm	6102.5130

Availability for all products can be searched real-time: <https://www.schurter.com/en/Stock-Check/Stock-Check-SCHURTER>

Articles for enhanced glow wire test requirements acc. IEC 60695-2-12 and -13 can be ordered with ending ".15" (xxxx.xxxx.15). They are suitable for the use in unattended household equipment acc. IEC 60335-1.

Packaging unit

50 Pcs

Accessories

Description



Assorted Covers  
Rear Cover

0859.0048

4311.9401

4311.9402



RC320  
Rear Cover for Power Entry Module



Cord retaining kits  
Cord retaining strain relief

Countersunk, C

4700.0003

Mating Outlets/Connectors

Category / Description

[Connector Overview complete](#)



4782 Mounting: Power Cord, 3 x 1 mm <sup>2</sup> / 3 x 18 AWG, Cable, Connector: IEC C13	4782
4785 Mounting: Power Cord, 3 x 1 mm <sup>2</sup> / 3 x 18 AWG, Cable, Connector: IEC C13	4785
4300-06 Mounting: Power Cord, 3 x 1 mm <sup>2</sup> / 3 x 18 AWG, Cable, Connector: IEC C13	4300-06
4781 Mounting: Power Cord, Cable, Connector: IEC C15	4781
4784 Mounting: Power Cord, 3 x 1 mm <sup>2</sup> / 3 x 18 AWG, Cable, Connector: IEC C15	4784

...

Mating Outlets/Connectors shuttered

[Power Cord Overview complete](#)



VAC17KS, V-Lock cord retaining, diverse m, Connector IEC C17, diverse, black / grey / white	VAC17KS
---	---------