



MP2731

Wide Input Range, 4.5A, I²C-Controlled SW Charger with NVDC Power Path and USB OTG

DESCRIPTION

The MP2731 is a 4.5A, highly integrated switch-mode battery charge management device for single-cell Li-ion or Li-polymer batteries. This device works with NVDC system power path management, and is suitable for a variety of applications, including smartphones, tablets, wireless cameras, and other portable devices. Its low-impedance power path optimizes efficiency, reduces battery charging time, and extends battery life. The I²C serial interface allows the device to be flexibly controlled due to its charging and system settings.

The MP2731 supports a wide range of input sources, including standard USB host ports and high-powered wall adapters with fast charge capabilities. The MP2731 provides USB input type detection via the DP/DM pins.

The device supports USB On-The-Go (OTG) operation by supplying default 5V on the input bus with an output current limit up to 3.0A.

The MP2731 initiates and completes a charging cycle without software control. It automatically detects the battery voltage and charges the battery in different stages. The charger automatically terminates when a full charge is detected. When the charged battery drops below the recharge threshold, the charger automatically starts another charging cycle.

The charger provides various safety features for battery charging and system operations, including a charging safety timer, battery temperature monitoring, over-voltage and over-current protections. When any fault occurs, the charger asserts an INT signal to host. The device provides BATFET disable control to enter shipping mode, as well as system reset functionality via the DISC pin.

The MP2731 is available in a QFN-26 (3.5mmx3.5mm) package.

FEATURES

- 3.7V to 16V Operating Input Voltage Range
- Up to 22V Sustainable Voltage
- **High-Efficiency, 4.5A, 1.35MHz Buck Charger: Up to 92% Charge Efficiency with 3A Charge Current:**
 - Configurable DP/DM for Flexible Fast Charge Protocol Support
- USB OTG with 4.8V to 5.5V Adjustable Output: Up to 3.0A Output, Up to 93% Efficiency with 1.5A Output
- **NVDC Power Path Management:**
 - Instant-On Works with No Battery or Deeply Discharged Battery
 - Ideal Diode Operation in Battery Supplement Mode
- High Battery Discharge Efficiency with 14mΩ BATFET Up to 8.5A
- I²C Port for Flexible System Parameter Setting and Status Reporting
- Fully Integrated Power MOSFETs and Current Sensing
- Dedicated DISC Pin to Control Shipping Mode and System Reset
- 13μA Low Battery Leakage Current in Shipping Mode
- Integrated ADC for Monitoring Input Voltage, Input Current, Battery Voltage, Charge Current, System Voltage, and Battery Temperature
- Charging Status Indicator
- Safety Features Including Configurable JEITA for Battery Temperature Protection for Charge Mode, Battery Charging Safety Timer, Thermal Regulation and Thermal Shutdown, Watchdog Monitoring I²C Operation, and Input/System Over-Voltage Protection

APPLICATIONS

- Tablet PCs
- Smartphones
- Wireless Cameras
- Other Portable Devices

All MPS parts are lead-free, halogen-free, and adhere to the RoHS directive. For MPS green status, please visit the MPS website under Quality Assurance. "MPS", the MPS logo, and "Simple, Easy Solutions" are trademarks of Monolithic Power Systems, Inc. or its subsidiaries.

TYPICAL APPLICATION

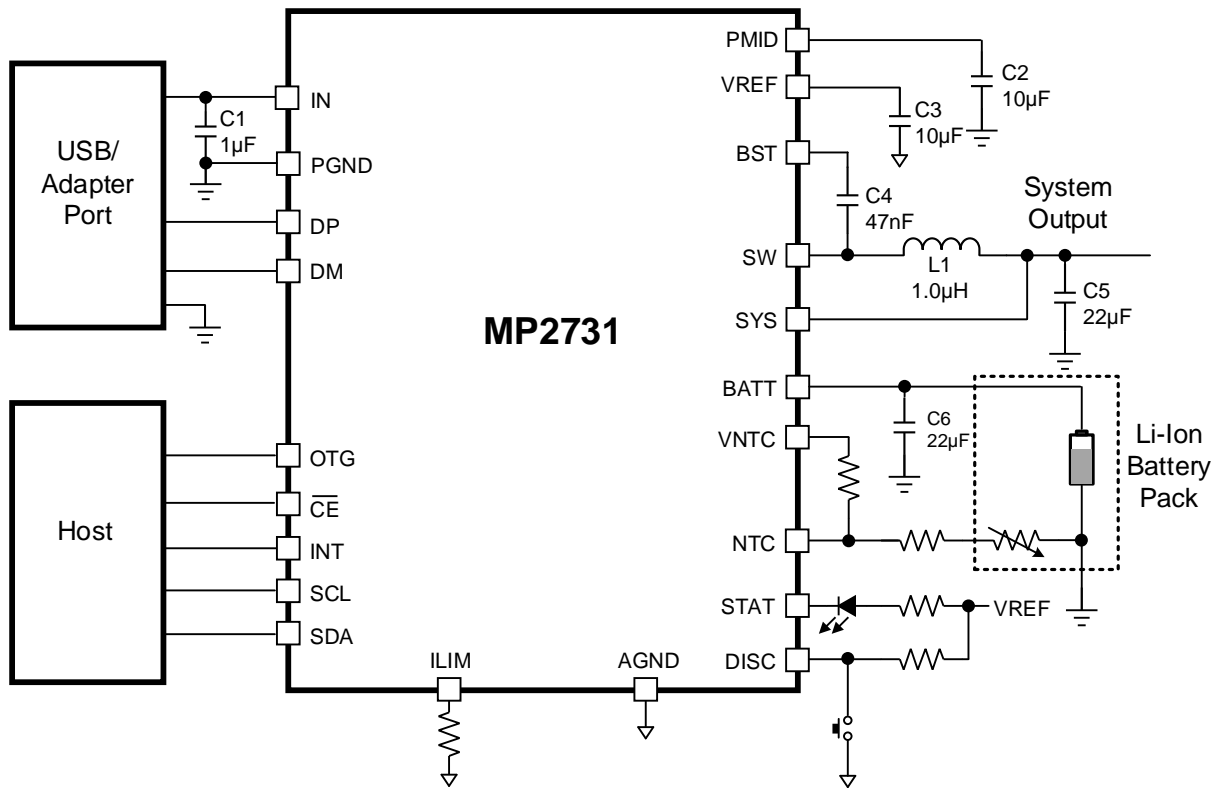

ORDERING INFORMATION

Part Number*	Package	Top Marking	MSL Rating
MP2731GQC-xxxx**	QFN-26 (3.5mmx3.5mm)	See Below	1

* For Tape & Reel, add suffix -Z (e.g. MP2731GQC-xxxx-Z).

**“-xxxx” is the register setting option. The factory default is “-0001”. This content can be viewed in the I²C Register Map on page 29. Contact an MPS FAE to obtain an “-xxxx” value.

TOP MARKING

BM**A**Y**W**

LL**L**L**L**

BMA: Product code of MP2731GQC

Y: Year code

W: Week code

LLLLL: Lot number

PACKAGE REFERENCE

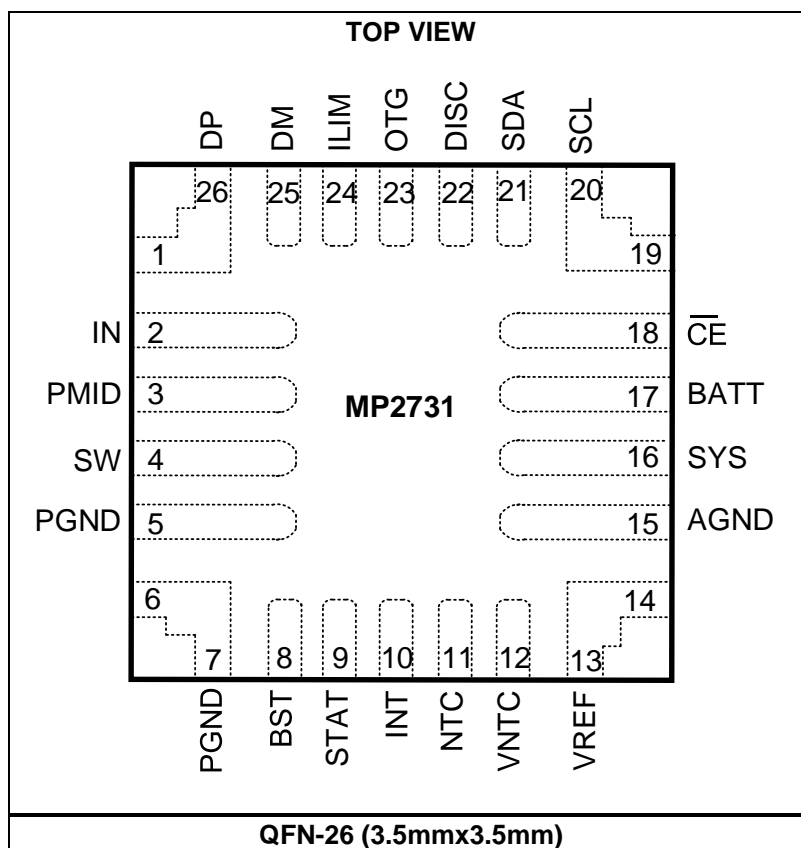

PIN FUNCTIONS

Pin #	Name	Type	Description
1, 26	DP	I/O	Positive pin of the USB data line pair.
2	IN	P	Power input of the IC. Place a 1 μ F ceramic capacitor from IN to PGND, as close as possible to the IC.
3	PMID	P	Internal power pin. Connect PMID to the drain of the reverse-blocking MOSFET and the drain of the high-side MOSFET. Bypass PMID with a 10 μ F capacitor from PMID to PGND, as close as possible to the IC.
4	SW	P	Switching node.
5, 6, 7	PGND	P	Power ground.
8	BST	P	Bootstrap pin. Connect a 47nF bootstrap capacitor between the BST and SW pins to form a floating supply across the power switch driver to drive the power switch's gate above the supply voltage.
9	STAT	O	Open-drain charge status output to indicate various charger operations. Connect STAT to VREF using a 10k Ω resistor.
10	INT	O	Open-drain interrupt output. The INT pin can send charging status and fault interrupt signals to the host.
11	NTC	I	Temperature-sense input. Connect a negative temperature coefficient thermistor to the NTC pin. Program the hot and cold temperature windows with a resistor divider from VNTC to NTC to AGND. Charging is suspended when the NTC pin is out of range.
12	VNTC	O	Pull-up voltage bias. The VNTC pin is the pull-voltage bias of the NTC comparator resistive divider for both the feedback and the reference.
13, 14	VREF	P	PWM low-side driver output. Connect a 10 μ F ceramic capacitor from VREF to AGND, as close as possible to the IC.
15	AGND	I/O	Analog ground.
16	SYS	P	System output. Connect a 22 μ F ceramic capacitor from SYS to PGND, as close as possible to the IC.
17	BATT	P	Battery positive terminal. Connect a 22 μ F ceramic capacitor from BATT to PGND, as close as possible to the IC.
18	$\overline{\text{CE}}$	I	Active low charge enable pin. Battery charging is enabled when the corresponding register is set to active and the $\overline{\text{CE}}$ pin is low.
19, 20	SCL	I	I²C interface clock. Connect SCL to the logic rail through a 10k Ω resistor.
21	SDA	I/O	I²C interface data. Connect SDA to the logic rail through a 10k Ω resistor.
22	DISC	I	Battery disconnection control pin. The DISC pin can be used for shipping mode and system resetting.
23	OTG	I	Boost mode enable control pin. The On-The-Go (OTG) function is enabled through the I ² C. During boost operation, the OTG pin can go low to suspend boost operation.
24	ILIM	I	Configurable input current limit. To set the maximum input current limit, connect a resistor from ILIM to ground. The actual input current limit is the lower value set by the ILIM pin or the I ² C.
25	DM	I/O	Negative pin of the USB data line pair.

ABSOLUTE MAXIMUM RATINGS ⁽¹⁾

IN, PMID to GND	-0.3V to +22V
SW to GND	-0.3V (-2V for 20ns) to +22V
BST to GND.....	SW to SW + 5V
BATT, SYS to GND.....	-0.3V to +6V
All other pins to GND	-0.3V to +5V
STAT, INT sink current	10mA
Continuous power dissipation (T _A = 25°C) ⁽²⁾	2.6W
Junction temperature.....	150°C
Lead temperature (solder)	260°C
Storage temperature.....	-65°C to +150°C

ESD Ratings

Human body model (HBM)	±2000V
Charged device model (CDM)	±750V

Recommended Operating Conditions ⁽³⁾

V _{IN} to GND	3.7V to 16V ⁽⁴⁾
I _{IN}	Up to 3.25A
I _{SYS}	Up to 4.5A
I _{CHG}	Up to 4.5A
V _{BATT}	Up to 4.67V
I _{DISCHARGE} (CONTINUOUS).....	Up to 8.5A
I _{DISCHARGE} (PULSE).....	Up to 9A
Operating junction temp (T _J)....	-40°C to +125°C

Thermal Resistance ⁽⁵⁾	θ_{JA}	θ_{JC}
QFN-26 (3.5mmx3.5mm).....	48.....	11... °C/W

Notes:

- 1) Exceeding these ratings may damage the device.
- 2) The maximum allowable power dissipation is a function of the maximum junction temperature, T_J (MAX), the junction-to-ambient thermal resistance, θ_{JA}, and the ambient temperature, T_A. The maximum allowable continuous power dissipation at any ambient temperature is calculated by P_D (MAX) = (T_J (MAX) - T_A) / θ_{JA}. Exceeding the maximum allowable power dissipation will cause excessive die temperature, and the regulator will go into thermal shutdown. Internal thermal shutdown circuitry protects the device from permanent damage.
- 3) The device is not guaranteed to function outside of its operating conditions.
- 4) The inherent switching noise voltage should not exceed the absolute maximum rating on either BST or SW pins. A tight layout minimizes switching loss.
- 5) Measured on JESD51-7, 4-layer PCB.

ELECTRICAL CHARACTERISTICS

V_{IN} = 5V, T_A = 25°C, unless otherwise noted.

Parameter	Symbol	Condition	Min	Typ	Max	Units
Step-Down Converter						
Input voltage range	V _{IN}		3.7		16 ⁽⁶⁾	V
Input suspend current	I _{IN_SUS}	V _{IN} > V _{IN_UVLO} , V _{IN} > V _{BATT} , suspend mode, EN_HIZ = 1		1	1.5	mA
Input quiescent current	I _{IN_Q}	V _{IN} > V _{IN_UVLO} , V _{IN} > V _{BATT} , V _{BATT} = 3.6V, converter switching, I _{SYS} = 0A		4		
Input under-voltage lockout threshold	V _{IN_UVLO}	V _{IN} falling		3	3.2	V
Input under-voltage lockout threshold hysteresis		V _{IN} rising		200		mV
Input vs. battery voltage headroom	V _{HDRM}	V _{IN} rising	230	300	370	mV
		V _{IN} falling	120	190	260	mV
Input over-voltage protection threshold	V _{IN_OVLO}	V _{IN} rising	5.8	6	6.3	V
		V _{IN} rising, for V _{IN} > 5V	16.2	16.7	17.2	
Input over-voltage protection threshold hysteresis		V _{IN} falling		380		mV
Internal reverse blocking MOSFET on resistance	R _{ON_Q1}	Measure from IN to PMID		20		mΩ
High-side MOSFET on resistance	R _{ON_Q2}	Measure from PMID to SW		25		mΩ
Low-side MOSFET on resistance	R _{ON_Q3}	Measure from SW to PGND		25		mΩ
Switching frequency	f _{SW}	V _{BATT} = 3.7V, I _{CHG} = 2A, REG04h, bit[7] = 0	1.1	1.35	1.6	MHz
SYS Output						
Minimum system regulation voltage (I ² C)	V _{SYS_REG_MIN}	V _{SYS_MIN} + V _{TRACK} , I _{SYS} = 0, V _{BATT} = 3.4V, REG04h, bits[3:1] = 110, REG04h bit[0] = 1		3.82		V
Battery track voltage	V _{TRACK}	REG04h, bit[0] = 0		100		mV
		REG04h, bit[0] = 1		150		mV
Ideal diode forward voltage in supplement mode	V _{FWD}	10mA discharge current		20		mV
SYS vs. BATT comparator	V _{SYS_GT_BATT}	V _{SYS} falling to enter ideal diode mode		-20		mV
SYS vs. BATT comparator hysteresis		V _{SYS} rising to exit ideal diode mode		50		mV
Battery good comparator (threshold compared with V _{SYS_MIN})	V _{BATT_GD}	V _{BATT} rising to the battery FET being turned on fully		60		mV
Battery good comparator hysteresis		V _{BATT} falling		100		mV

ELECTRICAL CHARACTERISTICS (continued)

V_{IN} = 5V, T_A = 25°C, unless otherwise noted.

Parameter	Symbol	Condition	Min	Typ	Max	Units
Battery Charger						
Battery charge voltage regulation (I ² C)	V _{BATT_REG}	Depends on the I ² C setting	3.4		4.67	V
Battery charge voltage regulation accuracy	V _{BATT_REG_ACC}	REG07h, bits[7:1] = 1010000, V _{BATT_REG} = 4.2V	-0.5		+0.5	%
		REG07h, bits[7:1] = 1011111, V _{BATT_REG} = 4.35V				
		REG07h, bits[7:1] = 1100100, V _{BATT_REG} = 4.4V				
Fast charge current (I ² C)	I _{CC}	Depends on the I ² C setting	320		4520	mA
Fast charge current accuracy	I _{CC_ACC}	I _{CC} bit[6:0] = 0000100, V _{BATT} = 3.8V	442	500	558	mA
		I _{CC} bit[6:0] = 0100110, V _{BATT} = 3.8V	1739	1850	1951	mA
		I _{CC} bit[6:0] = 1000011, V _{BATT} = 3.8V	2849	3000	3151	mA
		I _{CC} bit[6:0] = 1101001, V _{BATT} = 3.8V	4294	4520	4750	mA
Pre-charge to fast charge threshold (I ² C)	V _{BATT_PRE}	V _{BATT} rising, REG05h, bit[7] = 1	2.8	3.0	3.1	V
Pre-charge to fast charge hysteresis		V _{BATT} falling		160		mV
Trickle charge to pre-charge threshold	V _{BATT_TC}	V _{BATT} rising	1.9	2.0	2.1	V
Trickle charge to pre-charge threshold hysteresis		V _{BATT} falling		50		mV
Trickle-charge current	I _{TC}	V _{BATT} = 1.8V, IPRE bit[0] = 1		185		mA
		V _{BATT} = 1.8V, IPRE bit[0] = 0		145		
Pre-charge current (I ² C)	I _{PRE}	Depends on the I ² C setting	150		750	mA
Pre-charge current accuracy		V _{BATT} = 2.6V, REG06h, bits[7:4] = 0010	182	225	268	mA
Charge termination current threshold (I ² C)	I _{TERM}	Depends on the I ² C setting	120		720	mA
Termination current accuracy		V _{BATT_REG} = 4.2V, REG06h, bits[3:0] = 0110	298	360	422	mA
Charge termination deglitch time	t _{TERM_DGL}			200		ms
Auto-recharge voltage threshold below V _{BATT_REG}	V _{RECH}	REG07h, bit[0] = 0		110		mV
Auto-recharge deglitch time	t _{RECH_DGL}			200		ms
BATFET on resistance	R _{ON_Q4}	V _{BATT} = 3.8V		14		mΩ
Battery discharge current limit	I _{DSCHG_LMT}	V _{IN} = 0V, V _{BATT} = 3.8V, OTG disabled, I _{sys} rising	8.5			A
Battery discharge function controlled by the DISC pin	t _{DISC}	DISC pin low time to turn off the battery discharge function, REG0Ah, bits[1:0] = 00		8		s
		Battery discharge off time to turn on the battery discharge function, REG0Ah, bits[3:2] = 00		0.5		

ELECTRICAL CHARACTERISTICS (continued)
V_{IN} = 5V, T_A = 25°C, unless otherwise noted.

Parameter	Symbol	Condition	Min	Typ	Max	Units
Input Voltage and Input Current Regulation						
Input minimum voltage regulation (I ² C)	V _{IN_MIN}		3.7		15.2	V
Input minimum voltage regulation accuracy	V _{IN_MIN_ACC}	REG01h, bits[6:0] = 0000110, V _{IN_REG} = 4.3V	-3		+3	%
Input current limit	I _{IN_LIM}	USB500	400	450	500	mA
		USB900	750	825	900	
		1A	840	920	1000	
		CDP or 1.5A	1270	1400	1500	
		DCP	1570	1690	1800	
		2A	1750	1880	2000	
		2.1A	1840	1970	2100	
		2.4A	2050	2240	2400	
		3A	2640	2800	3000	
Protection						
Battery over-voltage protection threshold	V _{BATT_OVP}	Rising, compared to V _{BATT_REG}		103.5		%
Battery over-voltage protection threshold hysteresis		Compared to V _{BATT_REG}		1.5		%
Thermal regulation	T _{J_REG}	T _{J_REG} bit[1:0] = 11		112		°C
Thermal shutdown threshold ⁽⁶⁾	T _{J_SHDN}	T _J rising		150		°C
Thermal shutdown hysteresis ⁽⁶⁾				20		°C
NTC float threshold	V _{FLT}	As a percentage of V _{NTC}		95		%
NTC float threshold hysteresis		As a percentage of V _{NTC}		3.6		%
NTC low temp rising threshold	V _{COLD}	As a percentage of V _{NTC}	71	72	73	%
NTC low temp rising threshold hysteresis		As a percentage of V _{NTC}		1.3		%
NTC cool temp rising threshold	V _{COOL}	As a percentage of V _{NTC}	59	60	61	%
NTC cool temp rising threshold hysteresis		As a percentage of V _{NTC}		1.3		%
NTC warm temp falling threshold	V _{WARM}	As a percentage of V _{NTC}	39.3	40.3	41.3	%
NTC warm temp falling threshold hysteresis		As a percentage of V _{NTC}		1.5		%
NTC hot temp falling threshold	V _{HOT}	As a percentage of V _{NTC}	35.3	36.3	37.3	%
NTC hot temp falling threshold hysteresis		As a percentage of V _{NTC}		1.5		%

ELECTRICAL CHARACTERISTICS (continued)

V_{IN} = 5V, T_A = 25°C, unless otherwise noted.

Parameter	Symbol	Condition	Min	Typ	Max	Units
VREF LDO						
VREF LDO output voltage	V _{REF}	V _{IN} = 5V, I _{VREF} = 20mA		3.6		V
VREF LDO current limit	I _{REF_LMT}	V _{VREF} = 3.3V	40			mA
Battery Discharge Operation						
Battery operating range	V _{BATT}		2.6		4.75	V
Battery current in shipping mode	I _{BATT_SP}	V _{IN} < V _{IN_UVLO} , V _{BATT} = 4.2V, BATFET off		13	16	μA
Battery quiescent current	I _{BATT_Q}	V _{IN} < V _{IN_UVLO} , V _{BATT} = 4.2V, BATFET on, OTG disabled		40	47	μA
		V _{IN} < V _{IN_UVLO} , V _{BATT} = 4.2V, BATFET on, OTG enabled		5.0		mA
OTG output voltage	V _{IN_DSCHG}	REG03h, bits[5:3] = 011, I _{OTG} = 0A		5.07		V
OTG output voltage accuracy		As a percentage of V _{IN_DSCHG} , I _{OTG} = 0A	-2		+2	%
Battery operation UVLO	V _{BATT_UVLO}	V _{BATT} falling	2.35	2.45	2.55	V
		V _{BATT} rising	2.68	2.8	2.92	V
Battery operation UVLO for OTG	V _{BATT_UVLO_OTG}	V _{BATT} falling	2.45	2.55	2.65	V
		V _{BATT} rising		3.0		V
OTG output voltage protection threshold	V _{INOVP_DSC_HG}	V _{BATT} = 3.7V, OTG is enabled, force a voltage at IN until switching is off		6.15		V
OTG output voltage protection threshold hysteresis				330		mV
OTG output current limit (I ² C)	I _{IN_DSCHG}	REG03h, bits[2:0] = 000, V _{BATT} = 3.7V	0.5	0.6	0.7	A
		REG03h, bits[2:0] = 011, V _{BATT} = 3.7V	1.5	1.65	1.8	
		REG03h, bits[2:0] = 101, V _{BATT} = 3.7V	2.1	2.25	2.4	
		REG03h, bits[2:0] = 111, V _{BATT} = 3.7V	3.0	3.15	3.3	
Analog-to-Digital Converter (ADC)						
Resolution	RES			8		bits
Input voltage range	V _{IN}	Charge mode or OTG mode	3.6		15.3	V
Input voltage LSB	V _{IN_RES}			60		mV
Input voltage accuracy	V _{IN_ACC}	Charge mode or OTG mode, V _{IN} = 5V		2		LSB
Battery voltage range	V _{BATT}	Charge mode or OTG mode	0		5.1	V
Battery voltage LSB	V _{BATT_RES}			20		mV
Battery voltage accuracy	V _{BATT_ACC}	Charge mode or OTG mode, V _{BATT} = 3.8V		2		LSB
Charge current range	I _{CHG}	Charge mode	0		5.66	A
Charge current LSB	I _{CHG_RES}			17.5		mA
Charge current accuracy	I _{CHG_ACC}	Charge mode, I _{CHG} = 1.84A		3		LSB

ELECTRICAL CHARACTERISTICS (continued)

V_{IN} = 5V, T_A = 25°C, unless otherwise noted.

Parameter	Symbol	Condition	Min	Typ	Max	Units
System voltage range	V _{SYS}	Charge mode or OTG mode	0		5.1	V
System voltage LSB	V _{SYS_RES}			20		mV
System voltage accuracy	V _{SYS_ACC}	Charge mode or OTG mode, V _{SYS} = 3.8V		2		LSB
Input current range	I _{IN}	Charge mode	0		3.39	A
Input current LSB	I _{IN_RES}			13.3		mA
Input current accuracy	I _{IN_ACC}	Charge mode, I _{IN} = 500mA		4		LSB
NTC voltage range	V _{NTC}	Charge mode or OTG mode	0		100	%
NTC voltage LSB	V _{NTC_RES}			0.392		%
NTC voltage accuracy	V _{NTC_ACC}	Charge mode or OTG mode, V _{NTC} = 50%		2		LSB
DP/DM USB Detection						
DP DCD current source	I _{DP_SRC}		7	10	14	uA
DM pull-down resistance	R _{DM_DOWN}		14.3	20	24.8	kΩ
Data detect voltage	V _{DAT_REF}		0.25	0.325	0.4	V
DP/DM comparator threshold (2.9V)	V _{TH_2P9}		2.8	2.9	3.0	V
DP/DM comparator threshold (2.4V)	V _{TH_2P4}		2.3	2.4	2.5	V
DP/DM comparator threshold (2.2V)	V _{TH_2P2}		2.1	2.2	2.3	V
DP/DM comparator threshold (1.7V)	V _{TH_1V7}		1.6	1.7	1.8	V
DP voltage source	V _{DP_SRC}		0.5	0.6	0.7	V
DM voltage source	V _{DM_SRC}		0.5	0.6	0.7	V
DP sink current	I _{DP_SINK}		70	100	130	μA
DM sink current	I _{DM_SINK}		70	100	130	μA
Leakage current input DP/DM pin	I _{DP_LKG}		-1		+1	μA
	I _{DM_LKG}		-1		+1	μA
Logic I/O Pin Characteristics (STAT, INT, OTG, /CE, DISC)						
Low logic voltage threshold	V _{IL}				0.4	V
High logic voltage threshold	V _{IH}		1.3			V
I²C Interface (SDA, SCL)						
Input high threshold level	V _{IH}	V _{PULL_UP} = 1.8V, SDA and SCL	1.3			V
Input low threshold level	V _{IL}	V _{PULL_UP} = 1.8V, SDA and SCL			0.4	V
Output low threshold level	V _{OL}	I _{SINK} = 5mA			0.4	V
I ² C clock frequency	f _{SCL}				400	kHz
Clock Frequency and Watchdog Timer						
Clock frequency	f _{CLK}			5		MHz
Watchdog timer	t _{WDT}	REG08h, bits[5:4] = 11		160		s

Note:

6) Guaranteed by design.

TYPICAL PERFORMANCE CHARACTERISTICS

$V_{IN} = 5.0V$, $V_{BATT} = \text{full range}$, I²C-controlled, $I_{CHG} = 1.84A$, $I_{IN_LIM} = 3.0A$, $V_{IN_MIN} = 4.3V$, $L = 1.0\mu H$ (DCR = 14.9m Ω), $T_A = 25^\circ C$, unless otherwise noted.

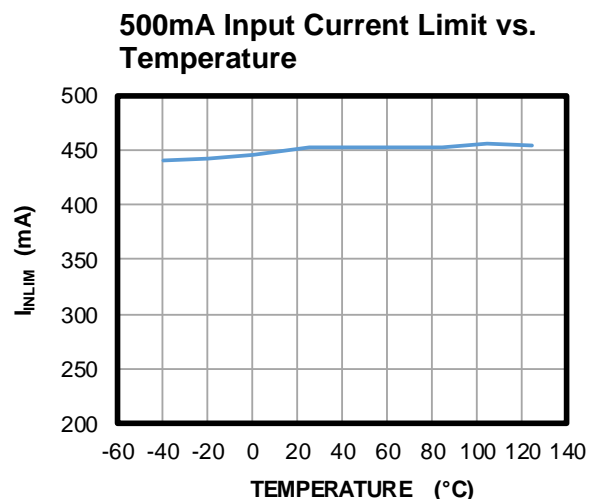
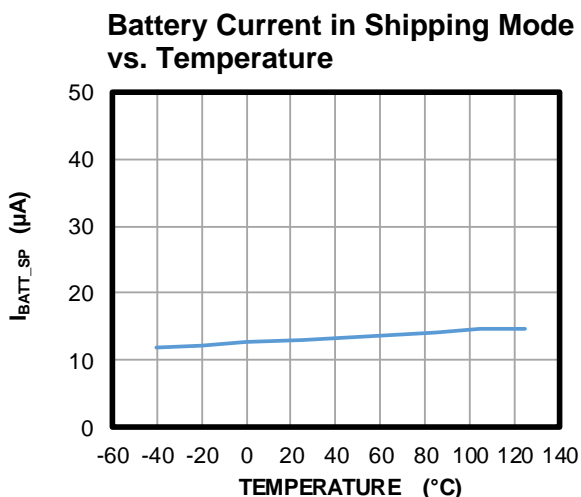
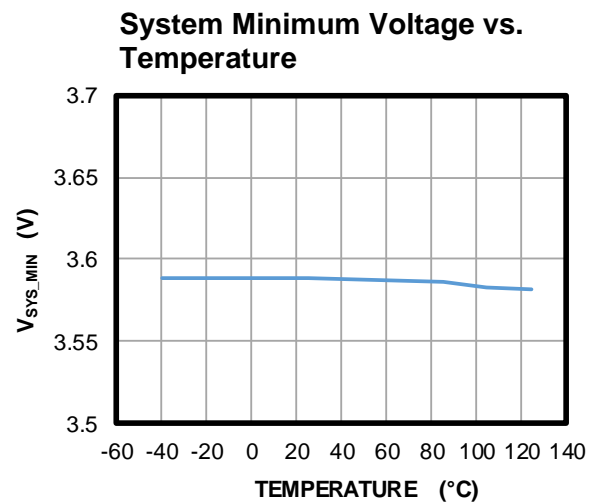
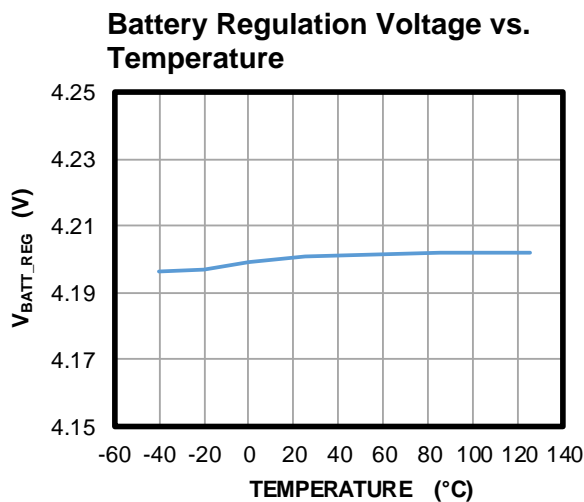
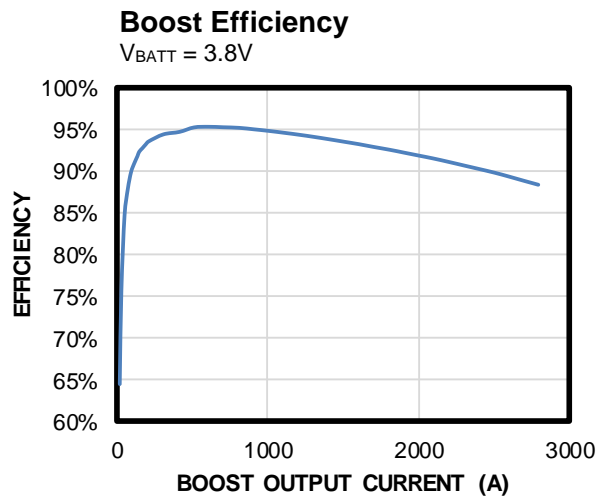
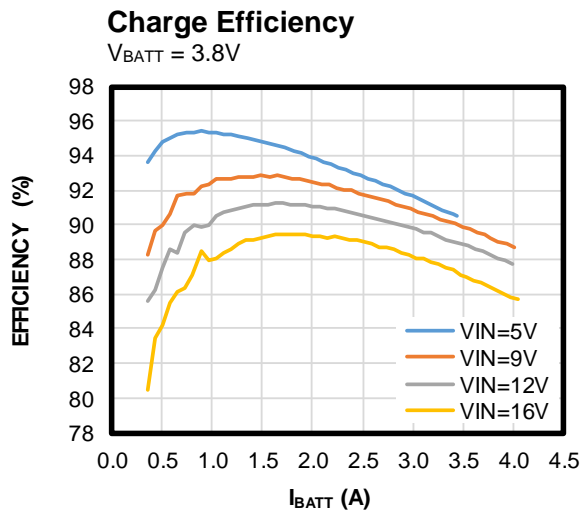

TYPICAL PERFORMANCE CHARACTERISTICS (continued)

V_{IN} = 5.0V, V_{BATT} = full range, I²C-controlled, I_{CHG} = 1.84A, I_{IN_LIM} = 3.0A, V_{IN_MIN} = 4.3V, L = 1.0μH (DCR = 14.9mΩ), T_A = 25°C, unless otherwise noted.

Battery Charge Curve

V_{IN} = 5V, V_{BATT_REG} = 4.2V, I_{SYS} = 0A

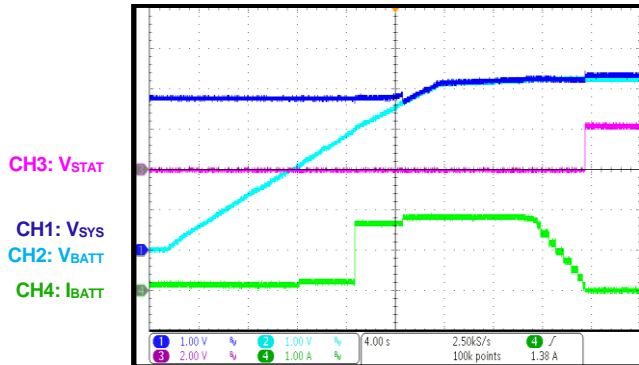

Auto-Recharge

V_{IN} = 5V, V_{BATT_REG} = 4.2V, I_{SYS} = 0A

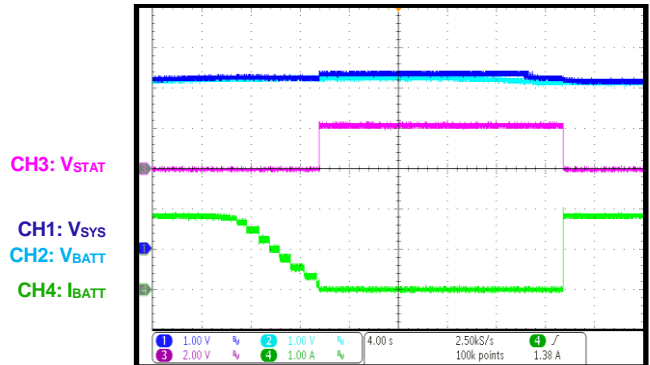

Trickle Charge

V_{IN} = 5V, V_{BATT} = 1.0V, I_{TC} = 145mA

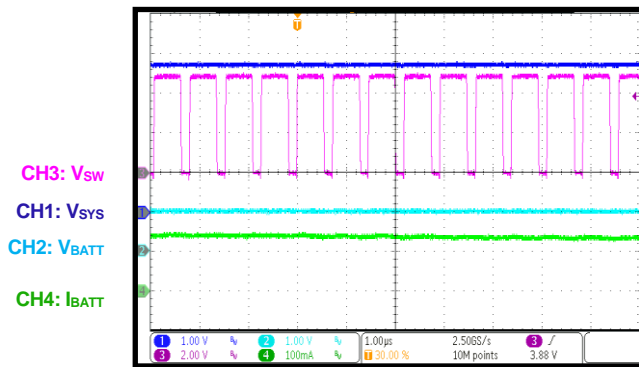

Pre-Charge

V_{IN} = 5V, V_{BATT} = 2.5V, I_{PRE} = 680mA

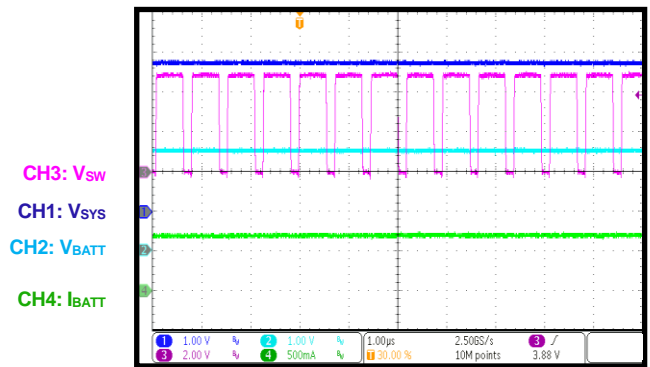

Constant Current Charge

V_{IN} = 5V, V_{BATT} = 3.3V, I_{CC} = 1840mA

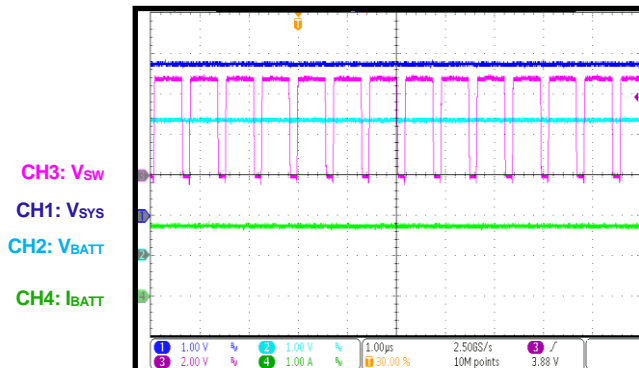

Constant Current Charge

V_{IN} = 5V, V_{BATT} = 3.8V, I_{CC} = 1840mA

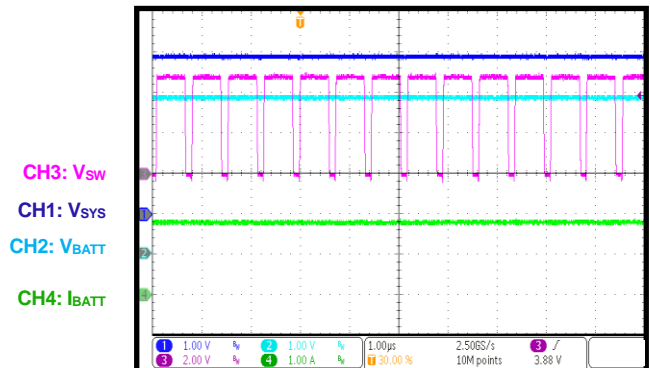

TYPICAL PERFORMANCE CHARACTERISTICS (continued)

V_{IN} = 5.0V, V_{BATT} = full range, I²C-controlled, I_{CHG} = 1.84A, I_{IN_LIM} = 3.0A, V_{IN_MIN} = 4.3V, L = 1.0μH (DCR = 14.9mΩ), T_A = 25°C, unless otherwise noted.

Constant Current Charge
V_{IN} = 9V, V_{BATT} = 3.3V, I_{CC} = 1840mA

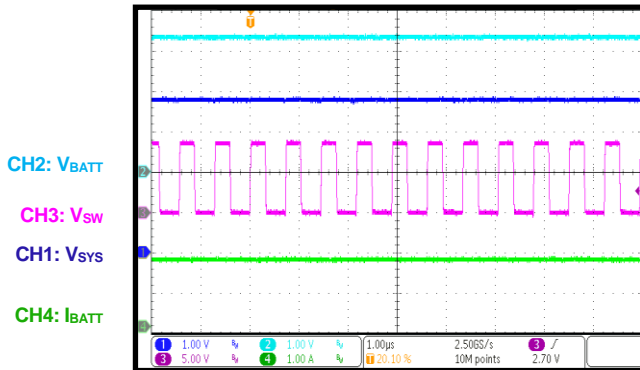

Constant Current Charge
V_{IN} = 9V, V_{BATT} = 3.8V, I_{CC} = 1840mA

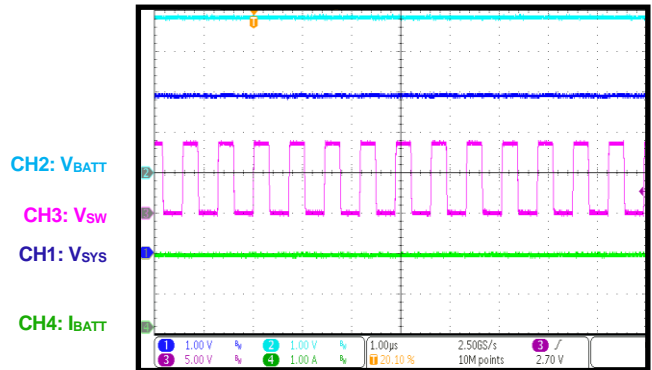

Constant Current Charge
V_{IN} = 12V, V_{BATT} = 3.3V, I_{CC} = 1840mA

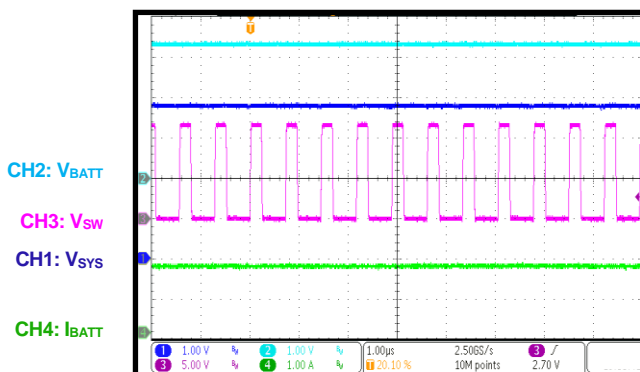

Constant Current Charge
V_{IN} = 12V, V_{BATT} = 3.8V, I_{CC} = 1840mA

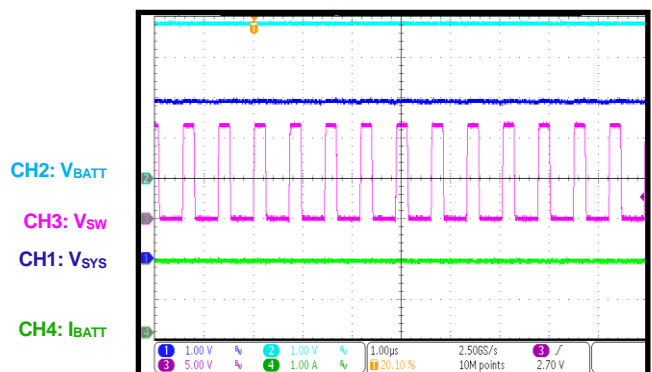

Constant Current Charge
V_{IN} = 16V, V_{BATT} = 3.3V, I_{CC} = 1840mA

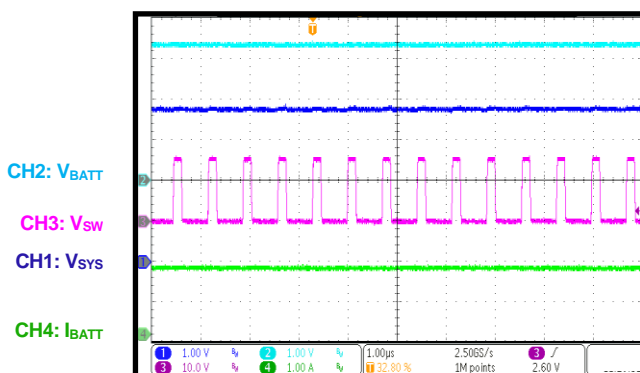

Constant Current Charge
V_{IN} = 16V, V_{BATT} = 3.8V, I_{CC} = 1840mA

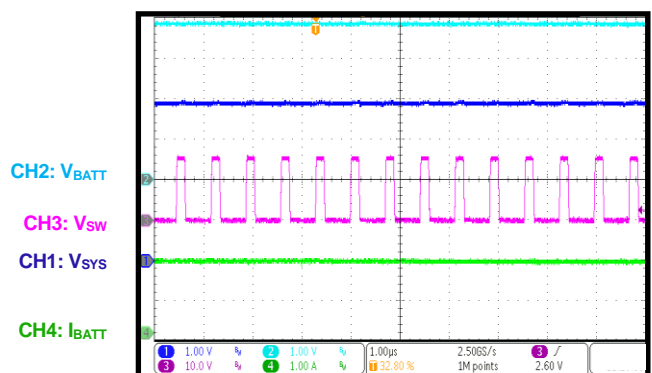

TYPICAL PERFORMANCE CHARACTERISTICS *(continued)*

$V_{IN} = 5.0V$, $V_{BATT} = \text{full range}$, I²C-controlled, $I_{CHG} = 1.84A$, $I_{IN_LIM} = 3.0A$, $V_{IN_MIN} = 4.3V$, $L = 1.0\mu H$ (DCR = 14.9m Ω), $T_A = 25^\circ C$, unless otherwise noted.

Battery Supplement Mode

$V_{IN} = 5V$, $V_{BATT} = 3.8V$, $I_{SYS} = 4.5A$

CH1: V_{sys}
CH3: V_{sw}
CH2: V_{batt}
CH4: I_{batt}

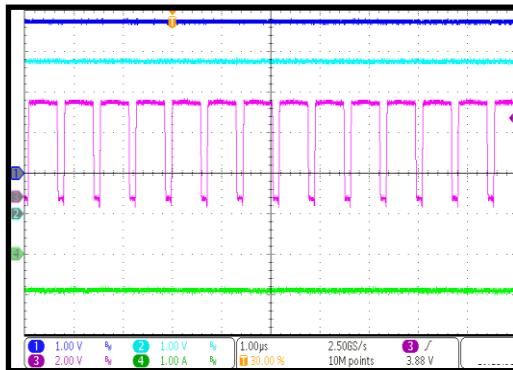

Constant Voltage Charge

$V_{IN} = 5V$, $V_{BATT} = 4.19V$, $I_{SYS} = 0A$

CH3: V_{sw}
CH1: V_{sys}
CH2: V_{batt}
CH4: I_{batt}

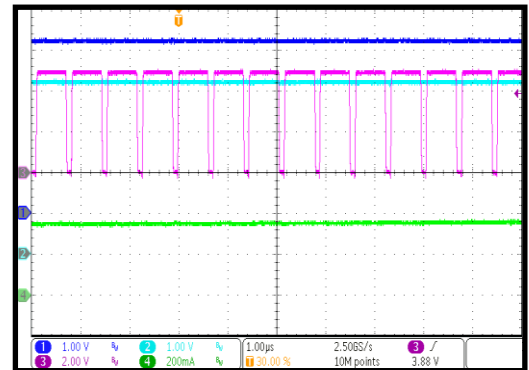

Input Current Limit

$V_{IN} = 5V$, $V_{BATT} = 3.8V$, $I_{IN_LIM} = 1800mA$

CH2: I_{in}
CH3: I_{sys}
CH4: I_{batt}
CH1: V_{sys}

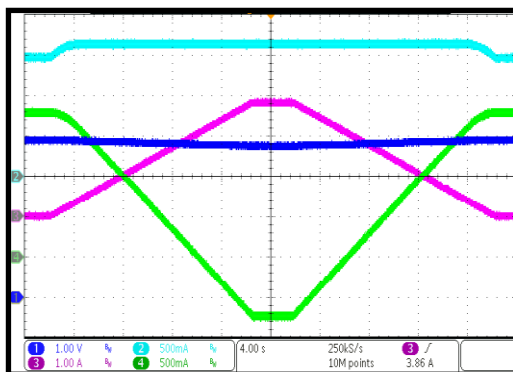

Input Voltage Limit

$V_{IN} = 5V$ (2A), $V_{BATT} = 3.3V$, $V_{IN_MIN} = 4.6V$

CH1: V_{sys}
CH2: I_{sys}
CH3: V_{in}
CH4: I_{batt}

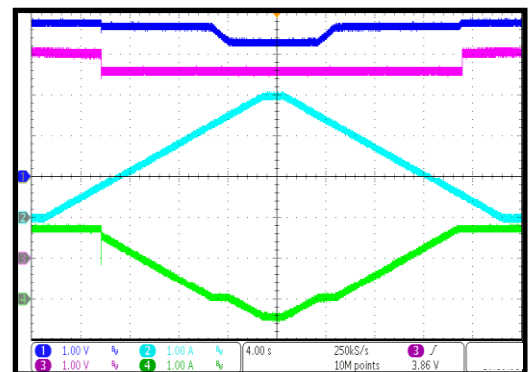

Power-On/Off Waveform

$V_{IN} = 5V$, $I_{IN_LIM} = 500mA$, $V_{BATT} = 3.8V$,
 $I_{SYS} = 2.5A$

CH2: V_{in}
CH3: V_{sw}
CH1: V_{sys}
CH4: I_{batt}

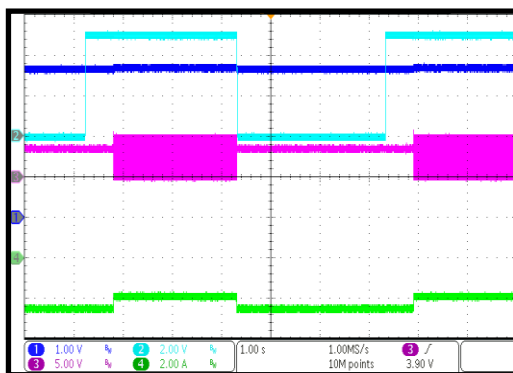

Power-On/Off Waveform

$V_{IN} = 5V$, $I_{IN_LIM} = 500mA$, $V_{BATT} = 3.3V$,
 $I_{SYS} = 0.5A$

CH2: V_{in}
CH3: V_{sw}
CH1: V_{sys}
CH4: I_{batt}

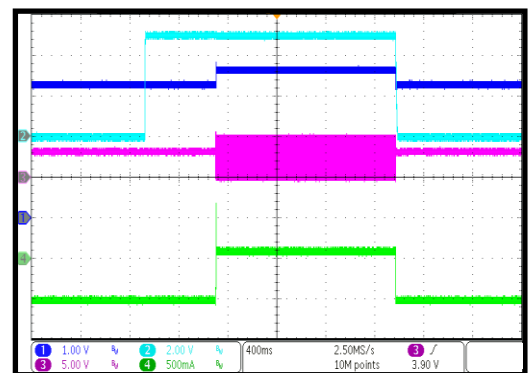

TYPICAL PERFORMANCE CHARACTERISTICS (continued)

V_{IN} = 5.0V, V_{BATT} = full range, I²C-controlled, I_{CHG} = 1.84A, I_{IN_LIM} = 3.0A, V_{IN_MIN} = 4.3V, L = 1.0μH (DCR = 14.9mΩ), T_A = 25°C, unless otherwise noted.

Suspend Mode On/Off

V_{IN} = 5V, I_{IN_LIM} = 500mA, V_{BATT} = 4.0V, I_{SYS} = 0.5A

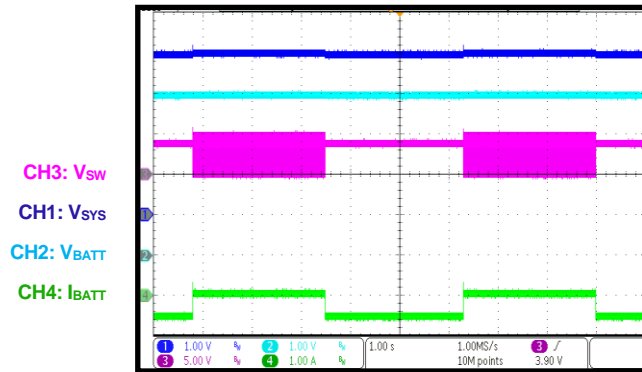

Charge On/Off

V_{IN} = 5V, V_{BATT} = 4.0V, I_{SYS} = 0A

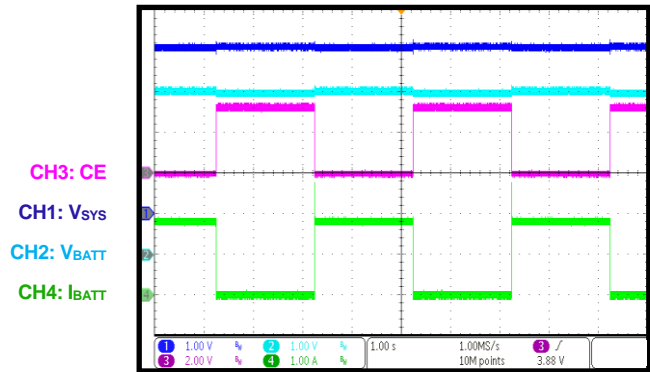

BATFET On/Off

V_{IN} = 5V, V_{BATT} = 4.0V, I_{SYS} = 4A

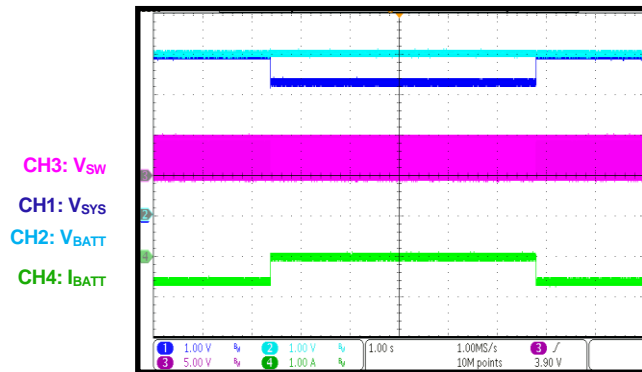

VIN Hot Insertion/Removal

V_{IN} = 5V, I_{IN_LIM} = 500mA, V_{BATT} = 3.8V

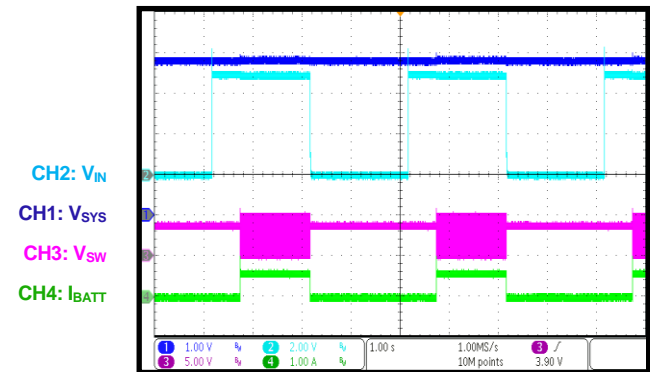

SYS Load Transient

V_{IN} = 5V, V_{BATT} = 3.3V, charge disable, I_{SYS} = 1A to 3A

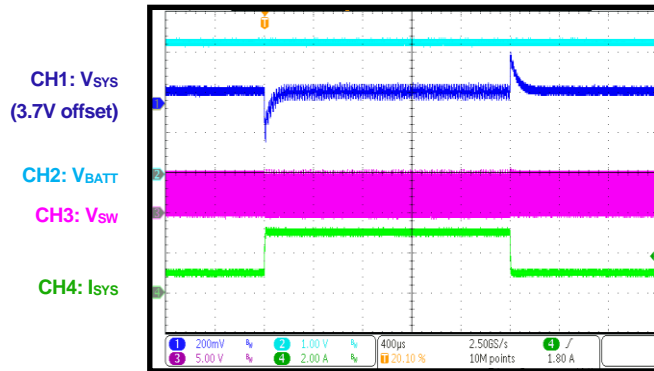

VIN OVP Test

V_{IN} = 5V to 17V, V_{BATT} = 3.8V, I_{SYS} = 1A

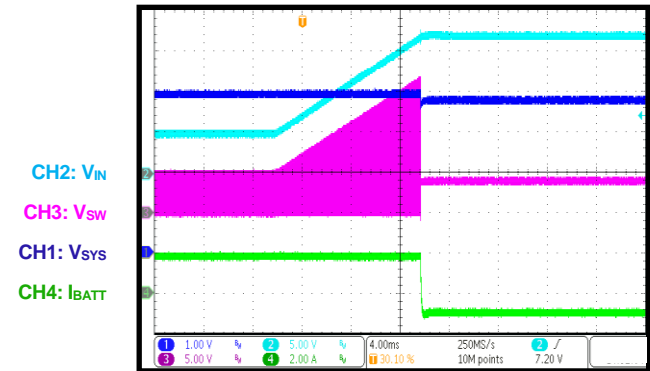

TYPICAL PERFORMANCE CHARACTERISTICS (continued)

V_{IN} = 5.0V, V_{BATT} = full range, I²C-controlled, I_{CHG} = 1.84A, I_{IN_LIM} = 3.0A, V_{IN_MIN} = 4.3V, L = 1.0μH (DCR = 14.9mΩ), T_A = 25°C, unless otherwise noted.

System Reset Mode

V_{IN} = float, V_{BATT} = 3.8V, I_{SYS} = 2A

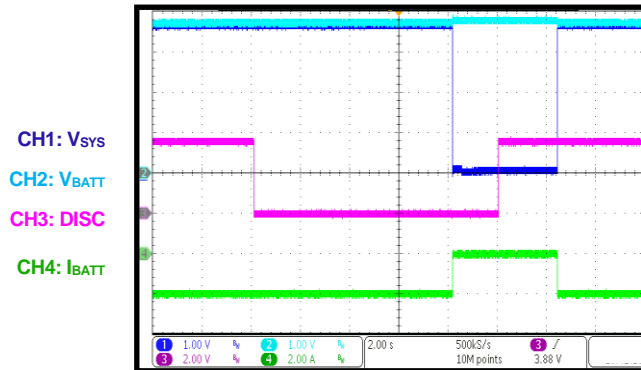

Battery Discharge Current

V_{IN} = float, V_{BATT} = 4.0V, I_{SYS} = 10A maximum

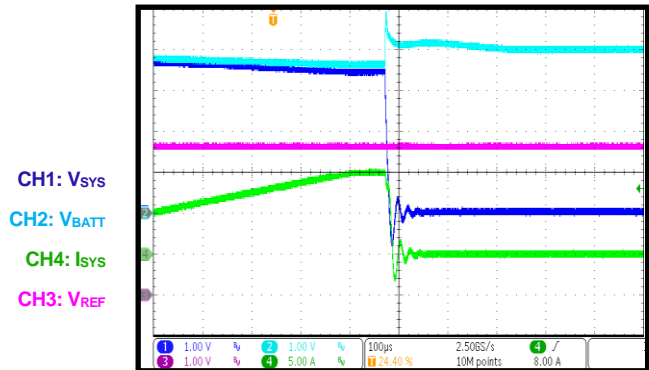

OTG Mode On

V_{IN} = float, OTG mode, V_{BATT} = 3.3V, I_{IN_DSCHG} = 0.5A, I_{OTG} = 0.5A

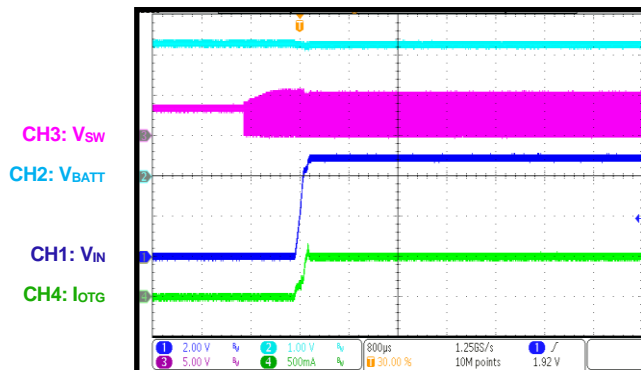

OTG Steady State Operation

V_{IN} = float, OTG mode, V_{BATT} = 4.0V, I_{IN_DSCHG} = 3.0A, I_{OTG} = 1.5A

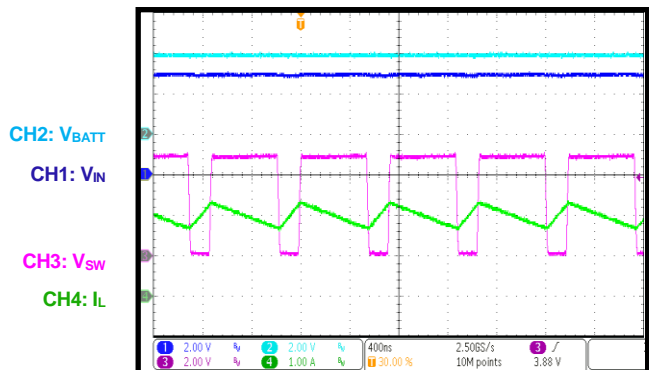

OTG Voltage Regulation

V_{IN} = float, OTG mode, V_{BATT} = 4.0V, I_{IN_DSCHG} = 1.5A, I_{OTG} = 0A to 1.5A

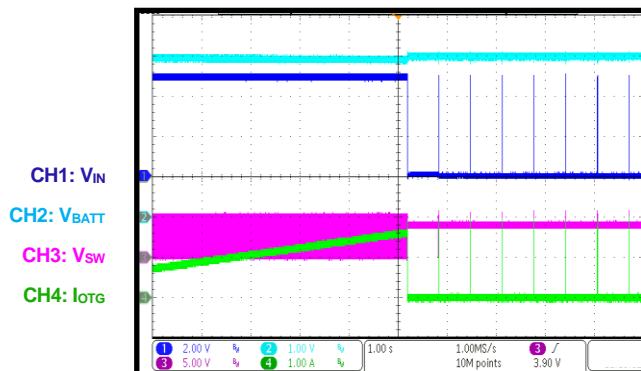

NTC JEITA Operation

V_{IN} = 5V, V_{BATT} = 4.07V, I_{sys} = 0A, JEITA_ISET = 50%, JEITA_VSET = -100mV

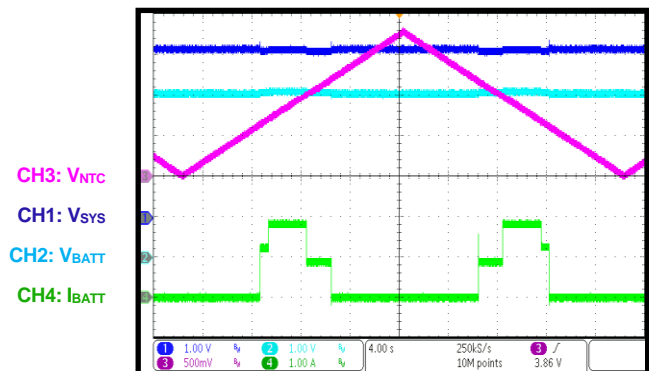

FUNCTIONAL BLOCK DIAGRAM

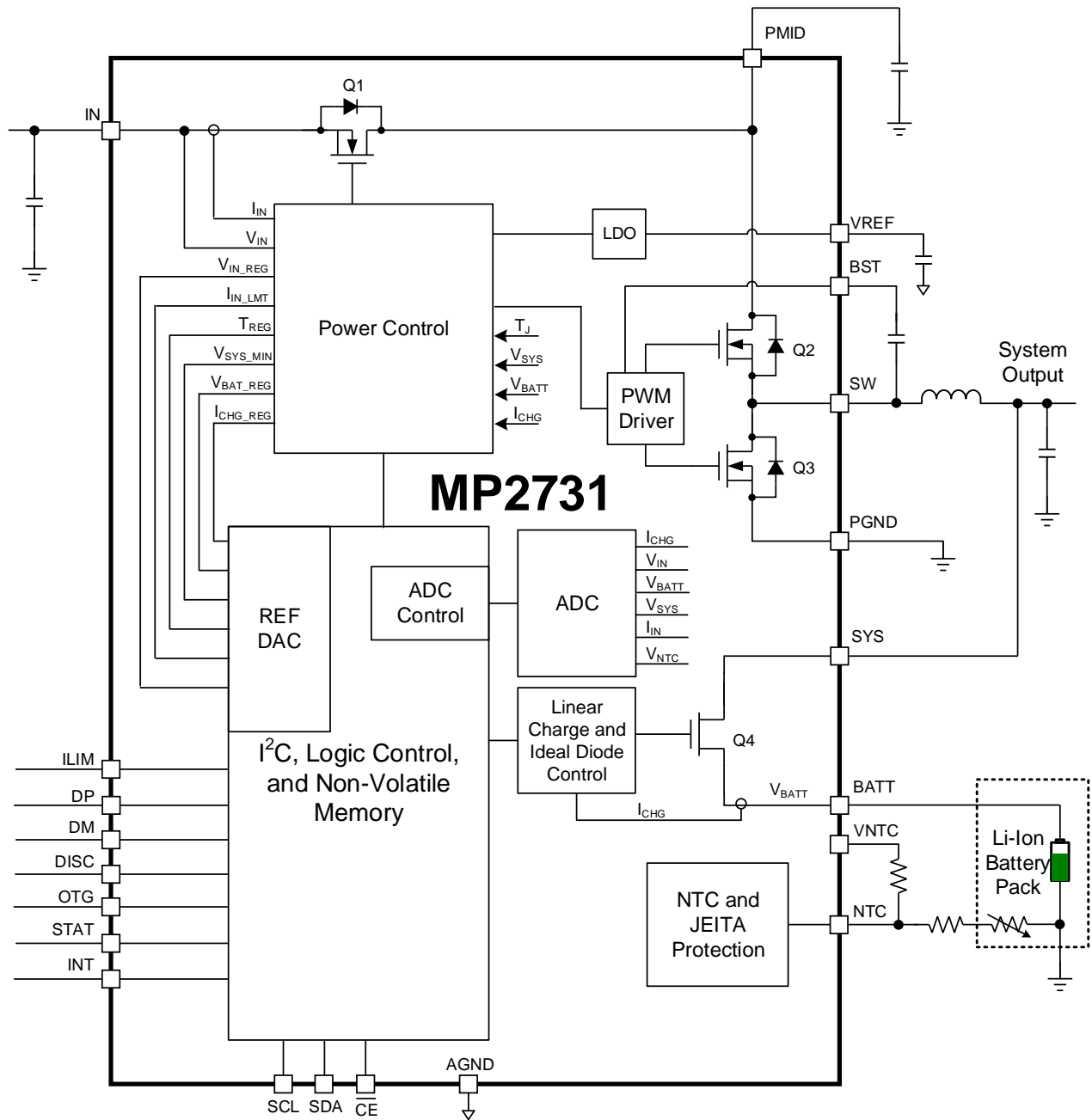

Figure 1: Functional Block Diagram

OPERATION

The MP2731 is a highly integrated, 4.5A, switch-mode battery charger IC with NVDC power path management for single-cell Li-ion or Li-polymer battery applications. The device integrates a reverse blocking FET (Q1), high-side switching FET (Q2), low-side switching FET (Q3), and battery FET (Q4) between the SYS and BATT pins.

Power Supply

The VREF pin's voltage supplies the internal bias circuits as well as the high-side and low-side MOSFET gate drive. The pull-up rail of STAT can also be connected to VREF. The VREF pin has an internal LDO, which has two inputs. One input is from IN, and the other is from a battery. IN and the battery voltage are connected to the input of the LDO via a PMOS.

Figure 2 shows the VREF power supply circuit.

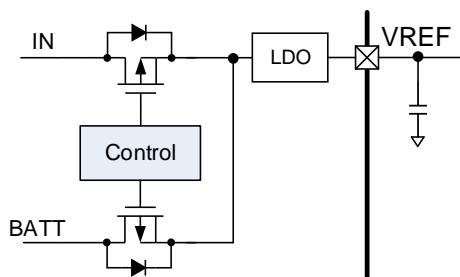

Figure 2: VREF Power Supply Circuit

Device Power-Up from Input Source

When an input source is plugged in, the MP2731 qualifies the input source before start-up. The input source must meet both of the following requirements:

1. $V_{IN} > V_{BATT} + V_{HDRM}$
2. $V_{IN_UVLO} < V_{IN} < V_{IN_OVLO}$

If the input power source meets the conditions above, a good input is detected and the device asserts an INT signal to the host. Then the device detects the input source type via the DP/DM pins. When DP/DM detection completes, the status register bit (VIN_STAT) changes, and an INT pulse is sent to the host. Then the device starts up the step-down converter.

NVDC Power Path Management

The MP2731 employs a narrow-voltage DC (NVDC) power structure with the battery FET,

decoupling the system from the battery and thus allowing separate controls between the system and the battery. The system is a priority during start-up, even if the battery is deeply discharged or missing. If the input power is available with a depleted battery, the system voltage is regulated at the minimum system voltage ($V_{SYS_REG_MIN}$).

Figure 3 shows the NVDC power structure, which is composed of a front-end, step-down DC/DC converter, and a battery FET placed between SYS and BATT pins.

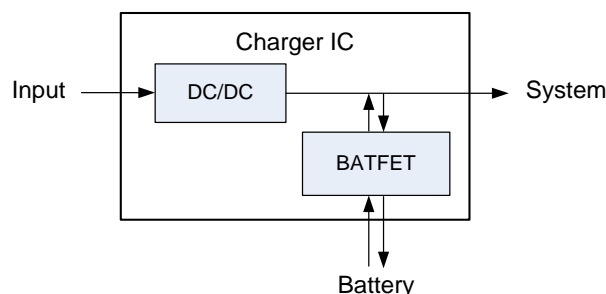

Figure 3: NVDC Power Path Management Structure

The DC/DC converter is a 1.35MHz step-down switching regulator, which directly drives the system load and charges the battery through the battery FET.

The system regulates the voltage in the following ways:

1. If the battery voltage drops below V_{SYS_MIN} , the system voltage is regulated at a minimum system voltage ($V_{SYS_REG_MIN}$), which exceeds V_{SYS_MIN} by V_{TRACK} . The battery FET works linearly to charge the battery via trickle charge, pre-charge, or fast charge current, depending on the battery voltage. V_{SYS_MIN} can be set via register REG04h, bits[3:1], and V_{TRACK} can be set via REG04h, bit[0].
2. When the battery voltage exceeds $V_{SYS_MIN} + V_{BATT_GD}$ (60mV), the battery FET fully turns on, and the voltage difference between the system and the battery is the V_{DS} of the BATFET. The charge current loop is implemented by the PWM control of the DC/DC converter.
3. If charging is suspended or completed (the battery FET is off), the system voltage is always regulated at its maximum value, $(V_{SYS_MIN}, V_{BATT}) + V_{TRACK}$.

Figure 4 illustrates charging voltage regulation.

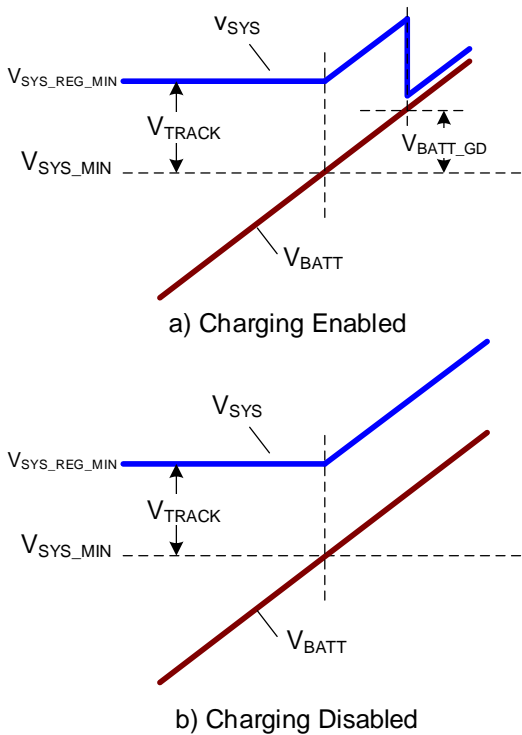

Figure 4: V_{SYS} Variation with V_{BATT}

Dynamic Power Management

To meet the maximum current limit in USB specifications and avoid overloading the adapter, the MP2731 features dynamic power management (DPM), and continuously monitors the input current and input voltage. The total input current limit is configurable to prevent the input source from being overloaded. If the input current increases and reaches the input current limit, the charge current is reduced to prioritize the system power.

If the preset input current limit exceeds the adapter’s rating, the additional minimum input voltage regulation loop activates to prevent the input power source from being overloaded. When the input voltage falls below the input voltage regulation threshold due to a heavy load, the charge current is reduced to prevent the input voltage from dropping further.

Power path management can operate in two ways:

1. If $V_{BATT} < V_{SYS_MIN} + V_{BATT_GD}$, the system voltage is regulated at $V_{SYS_REG_MIN}$. If the input current or voltage regulation threshold is reached, the input current loop or input

voltage loop controls the DC/DC converter, the system voltage drops, and the battery FET driver is pulled down to decrease the charge current. This prioritizes the system power requirement.

2. This case occurs if the battery is directly connected to the system, and $V_{BATT} > V_{SYS_MIN} + V_{BATT_GD}$. Due to the free transition between each control loop, the charge decreases automatically when the input current limit or voltage regulation threshold is reached.

Battery Supplement Mode

If the device reaches the input current limit or input voltage threshold, the charge current decreases. If the input source is still overloaded when the charge current decreases to zero, the system voltage starts to collapse. If the system voltage drops below the battery voltage, the MP2731 enters battery supplement mode, in which the battery simultaneously powers the system and the DC/DC converter.

The MP2731 can operate in ideal diode mode to optimize the control transition between the battery FET and DC/DC converter. The battery FET enters ideal diode under either of the following conditions:

1. V_{IN} starts up from the battery supply system.
2. $V_{BATT} < V_{SYS_MIN}$, and the system voltage drops below the battery voltage.

During ideal diode mode, the battery FET operates as an ideal diode, and regulates the gate drive of battery FET. The V_{DS} of the battery FET remains at about 20mV. As the discharge current increases, the battery FET’s gate drive increases and its R_{DS} decreases until the battery FET is fully on.

Battery Charge Profile

If V_{IN} powers on, CHG_CONFIG bit = 01, and the CE pin is low, then the device automatically completes a charging cycle without host involvement. However, the host can set different charging parameters to optimize the charge profile by writing to the corresponding registers via the I²C.

A new charge cycle starts when all of the following conditions are valid:

1. Good input power is inserted
2. Battery charging is enabled by the I²C, and CE is forced to a low logic
3. No thermistor fault on the NTC pin
4. No safety timer fault
5. BATFET is not forced to turn off

The MP2731 provides four main charging phases: trickle charge, pre-charge, constant current charge, and constant voltage charge, described below:

Phase 1 (trickle charge): When the input power qualifies as a good power supply, the MP2731 checks the battery voltage to determine whether trickle charge is required. If the battery voltage is below V_{BATT_TC} (2.0V), a trickle-charge current is applied on the battery, which helps reset the protection circuit in the battery pack. The trickle-charge current can be set via REG06h, bit[4]. If REG06h, bit[4] is set to 1, the trickle-charge current is 185mA. If REG06h, bit[4] is set to 0, the trickle-charge current is 145mA.

Phase 2 (pre-charge): If the battery voltage exceeds V_{BATT_TC} , the MP2731 starts to safely pre-charge the depleted battery until the battery voltage reaches the pre-charge to fast charge threshold (V_{BATT_PRE}). If V_{BATT_PRE} is not reached before the pre-charge timer (1hr) expires, the charge cycle ends and a corresponding timeout fault signal is asserted. The pre-charge current can be configured via I²C register REG06h,

bits[7:4], and can be set between 150mA and 750mA.

Phase 3 (constant current charge): If the battery voltage exceeds V_{BATT_PRE} (set via REG05h, bit[7]), the MP2731 enters a constant current charge (fast-charge) phase. The fast-charge current can be configured to as high as to 4.5A via REG05h, bits[5:0].

There are two stages of fast charge. First, the battery FET works linearly to charge the battery with fast charge current. Once the battery voltage exceeds $V_{SYS_MIN} + V_{BATT_GD}$, the battery FET fully turns on. The charge current loop is implemented by the PWM control of the buck converter.

Phase 4 (constant voltage charge): When the battery voltage rises to the configurable float voltage (V_{BATT_REG}) set via REG07h, bits[7:1], the charge current begins to taper off.

The charge cycle is considered complete when the charge current reaches the battery termination threshold (I_{TERM}) set via REG06h, bits[3:0] after a 200ms termination deglitch time, assuming the termination function is enabled if REG08h, bit[7] is set to 1. If I_{TERM} is not reached before the safety charge timer expires (see the Safety Timer section on page 24), the charge cycle ends and a corresponding timeout fault signal is asserted.

Figure 5 shows the charge profile.

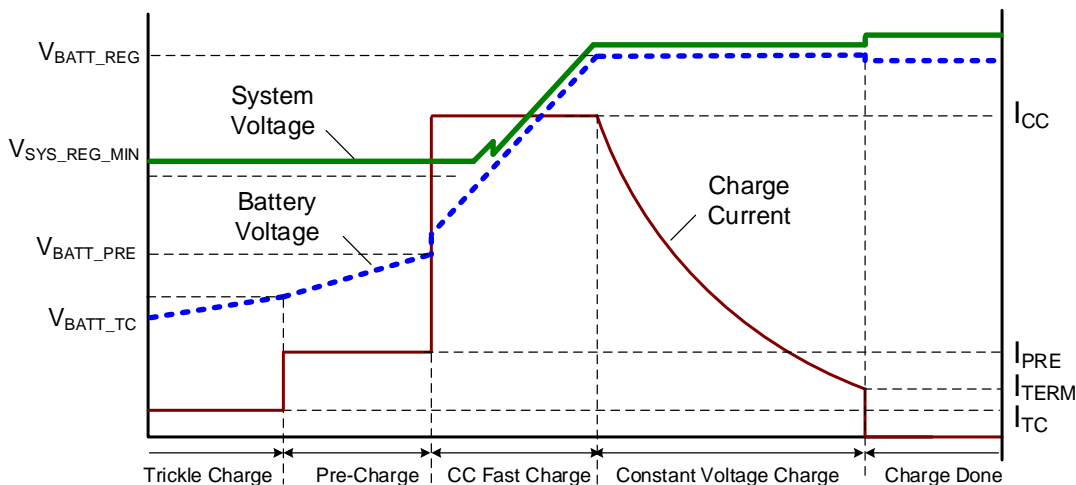

Figure 5: Battery Charge Profile

During the charging process, the actual charge current may be less than the register setting due to other loop regulations, like dynamic power management (DPM) regulation (input current limit or input voltage regulation loop) or thermal regulation. The thermal regulation reduces the charge current so that the IC junction temperature does not exceed the preset limit. The multiple thermal regulation thresholds from 60°C to 120°C help the system design meet the thermal requirements of different applications. The junction temperature regulation threshold can be set via REG02h, bits[3:2].

Auto-Recharge

When the battery is done charging, the battery may be discharged due to system consumption or self-discharge. When the battery voltage is discharged below the recharge threshold after a 200ms auto-recharge deglitch time, the MP2731 automatically starts another charging cycle.

CE Control

CE is a logic input pin that enables or disables battery charging, or restarts a new charging cycle. Battery charging is enabled when CHG_CONFIG (REG04h, bits[5:4]) is set to 01 and the CE pin is pulled to logic low.

Battery Over-Voltage Protection (OVP)

The MP2731 is designed with built-in battery over-voltage protection (OVP). If the battery voltage exceeds 103.5% of V_{BATT_REG} , the MP2731 immediately suspends the charging and asserts a fault. If battery OVP occurs, charging is disabled but the DC/DC converter continues operating.

System Over-Voltage Protection

The MP2731 monitors the voltage at the SYS pin. If an over-voltage condition ($V_{SYS} > V_{BATT_REG} + 0.4V$) is detected, the DC/DC converter turns off and the system is powered by the battery via the battery FET.

Automatic Input Current Optimizer (AICO)

The device provides an optimized input current limit without overloading the input source. This function can be enabled or disabled by configuring the AICO_EN bit, which is disabled by default. If AICO is enabled, I_{IN_LIM} is set to a larger current, and the input voltage drops to

V_{IN_MIN} , the AICO function is triggered. This function decreases I_{IN_LIM} step by step until the input voltage exits V_{IN_MIN} control. The input current limit remains optimized and does not automatically run the AICO function unless another V_{IN_MIN} event occurs.

The actual input current limit is reported in the I_{IN_DPM} register when the AICO function is enabled (AICO_EN = 1). If the AICO function is disabled (AICO_EN = 0), the input current limit is set by the I_{IN_LIM} register. Any write to I_{IN_LIM} can reset I_{IN_DPM} to the same I_{IN_LIM} value when the AICO function is enabled.

Input Source Type Detection

The MP2731 features input source detection compatible with USB Battery Charging Specification 1.2 (BC1.2) and nonstandard adapters. The user can force DP/DM detection in the host mode by writing 1 to the USB_DET_EN bit (REG0Bh, bit[5]).

When the input voltage is first applied and a good input source is detected, BC1.2 detection first begins with data content detection (DCD). If DCD is effective, the standard downstream port (SDP), charging downstream port (CDP), and dedicated charging port (DCP) can be distinguished. If the 500ms DCD timer expires, then the MP2731 proceeds with nonstandard adapter detection.

DCD uses a current source to detect when the data pins have made contact during an attach event. The protocol for DCD is as follows:

1. The portable device (PD) detects V_{IN} assertion.
2. The PD turns on DP I_{DP_SRC} and the DM pull-down resistor.
3. The PD waits for the DP line to be low.
4. If the DP line is detected low for 10ms, the PD starts primary detection.
5. If data contact is not detected, the DCD timer (500ms) expires.

After the DCD timer expires, the PD turns off I_{DP_SRC} and the DM pull-down resistor. Then the 50ms timer starts, and the PD can detect a special adapter. If a special adapter is detected, an INT is sent to the host. Otherwise, the PD starts primary detection after the 50ms timer expires.

Primary detection is used to distinguish between USB hosts (or the SDP) and different types of charging ports. During primary detection, the IC turns on V_{DP_SRC} on DP, and I_{DM_SINK} on DM. If the portable device is attached to a USB host, the DM pin pulls low. The SDP is detected, and an INT signal is sent to the host.

If the DM pin is high, the IC goes into secondary detection, which distinguishes between a CDP and a DCP.

During secondary detection, the IC turns on V_{DM_SRC} on DM, and I_{DP_SINK} on DP. If the input source is a CDP port and DP is low, then the CDP is detected and an INT signal is sent to the host.

If DP is high, the DCP source is detected, and an INT is sent to host. In this case, after turning off V_{DM_SRC} and I_{DP_SINK} , V_{DP_SRC} is applied to DP, and the IC goes to fast-charge detection.

Fast-charge detection identifies whether the input source has fast-charge capability.

If DM is always high during fast-charge detection, the input source has no fast-charge capability. If DM is low for 40ms, and the input source has fast-charge capability, the MP2731 sends an INT signal to the host. The MP2731 features an I²C-configurable DP/DM output for host-controlled communication, with various fast-charge protocols.

Table 1 lists input current limits that are compatible with USB specifications and BC1.2.

Table 1: Input Current Limit vs. USB Type

DP/DM Detection	I _{IN_LIM} (A)	V _{IN_OVP} (V)	V _{IN_MIN} (V)
Nonstandard adapter (1A)	1	6	3.7 to 5.2
Nonstandard adapter (2.1A)	2.1	6	3.7 to 5.2
Nonstandard adapter (2.4A)	2.4	6	3.7 to 5.2
SDP	0.5	6	3.7 to 5.2
CDP	1.5	6	3.7 to 5.2
DCP	1.8	6	3.7 to 5.2

USB detection is independent of the charge enable status. After DP/DM detection completes, the MP2731 indicates the USB port type in status register VIN_STAT (REG0Ch, bits[7:5]), and asserts an INT signal to the host. The host can revise the input current limit according to VIN_STAT.

Input Current Limit Setting via ILIM

For safe operation, the MP2731 has an additional hardware pin (ILIM) to adjust the maximum input current limit. The limit can be set by connecting a resistor from ILIM to GND. The actual input current limit is the lower value between what is set by the ILIM pin and the value set by the I²C.

The current limit set by the ILIM pin can be calculated with Equation (1):

$$I_{IN_LIM} = \frac{120}{R_{ILIM} (k\Omega)} (A) \quad (1)$$

Battery Temperature Monitor in Charge Mode

The MP2731 continuously monitors the battery’s temperature by measuring the voltage at the NTC pin. This value is typically determined by a negative temperature coefficient (NTC) thermistor and external voltage dividers. For the NTC thermistor, a hotter ambient temperature corresponds with a lower resistance and voltage ratio, and vice versa.

Figure 6 shows an NTC protection circuit. The external resistor dividers and the internal reference resistor series are pulled up to the VNTC pin. The voltage ratios between the internal and external dividers are compared to determine if an NTC protection has been triggered. The VNTC voltage (1.7V) is regulated by an LDO that is powered from VREF. The VNTC pin is available in both charge mode and OTG mode.

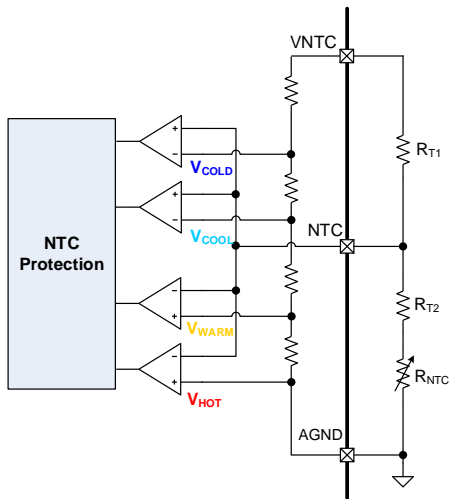

Figure 6: NTC Protection Circuit

The MP2731 provides standard and JEITA battery temperature monitoring, which can be selected by the NTC_TYPE bit. If the standard type is selected, and the external voltage ratio transitions from the high temperature threshold (V_{HOT}) to the low temperature threshold (V_{COLD}), this means that the battery temperature is out of the cold-to-hot range. The IC suspends charging and reports the NTC fault. Charging resumes automatically once the battery temperature is within the cold-to-hot temperature range again.

If the JEITA type is selected, the MP2731 monitors four temperature thresholds: the cold temperature threshold ($T_{NTC} < 0^{\circ}C$, default), the cool temperature threshold ($0^{\circ}C < T_{NTC} < 15^{\circ}C$, default), the warm temperature threshold ($45^{\circ}C < T_{NTC} < 55^{\circ}C$, default), and the hot temperature threshold ($T_{NTC} > 55^{\circ}C$, default).

For a given NTC thermistor, these temperatures correspond to the values for V_{COLD} , V_{COOL} , V_{WARM} , and V_{HOT} . These voltage thresholds can be configured via REG16h, bits[5:0] to set different temperature ranges.

If $V_{NTC} < V_{HOT}$ or $V_{NTC} > V_{COLD}$, the charging and timers are suspended. If $V_{HOT} < V_{NTC} < V_{WARM}$, the battery regulation voltage (V_{BATT_REG}) is reduced by 200mV, which can be configured via REG16h, bit[7]. If $V_{COOL} < V_{NTC} < V_{COLD}$, the charging current is reduced to 16.7%, which can be configured via REG16h, bit[6]. Figure 7 shows JEITA control.

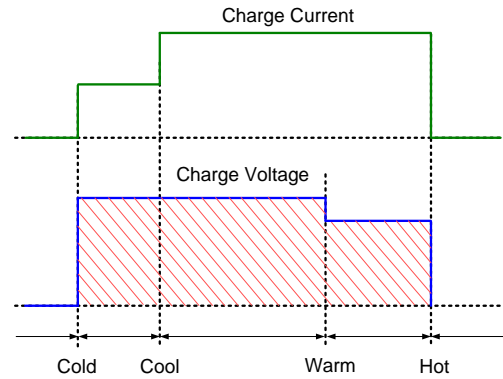

Figure 7: NTC Window under JEITA Control

The MP2731 provides PCB over-temperature monitoring. The PCB over-temperature response is selected by the NTC_OPT bit (REG02h, bit[1]). If this bit is set to 1, PCB over-temperature protection is enabled. If this bit is set to 0 (the default setting), the battery temperature monitoring and corresponding protection features mentioned above are utilized instead.

While monitoring over-temperature conditions in the PCB, the IC continuously monitors the PCB temperature at the NTC pin. If the NTC pin voltage is below the threshold that reuses V_{HOT} , the DC/DC converter and battery FET turn off. Operation resumes once the NTC pin voltage returns to the normal value.

If the NTC thermistor is removed, NTC is pulled up to V_{NTC} (see Figure 6). If the NTC voltage exceeds 95% of V_{NTC} , then the NTC thermistor float is detected. The MP2731 sends an INT signal to the host, and the RNTC_FLOAT_STAT bit is set to 1.

Battery Temperature Monitor in OTG Boost Mode

In boost mode, the device monitors the battery temperature to be within the V_{COLD} and V_{HOT} thresholds unless boost mode temperature monitoring is disabled by setting EN_OTG_NTC (REG02h, bit[5]) to 0. If the temperature is outside of the temperature thresholds, boost mode is suspended. Once the temperature is within the thresholds again, boost mode resumes.

Charging STAT Indication

The MP2731 indicates the charging state on the open-drain STAT pin. Table 2 shows the STAT status. The STAT pin function can be disabled by setting the STAT_EN bit to 0.

Table 2: Operation Indications

Charging State	STAT
Charging	Low
Charging complete, charge disabled, input OVP, battery discharge mode	High
Charging suspended (battery OVP, system OVP, timer fault, NTC fault, NTC float)	Blinking at 1Hz

Interrupt to Host (INT)

The MP2731 also has an alert mechanism that can output an interrupt signal via the INT pin to notify the system of the operation by outputting a 256µs, low-state INT pulse. The events that can trigger an INT output are listed below:

- Good input source detected
- DP/DM USB detection completed
- Input removed
- Charge completed
- NTC float is detected
- VINPPM or IINPPM is reached
- Any fault in REG0Dh (watchdog timer fault, OTG fault, thermal shutdown, safety timer fault, battery OVP fault, NTC fault)

If a fault occurs, the charger device sends out INT signal. The fault is not latched, and always reports the current conditions.

Safety Timer

The MP2731 provides both a pre-charge and complete charge safety timer to prevent extended charging cycles due to abnormal battery conditions. The total safety timer for both trickle charge and pre-charge is 1 hour when the battery voltage is below V_{BATT_PRE} . The complete charge safety timer starts when the battery enters constant current charge. The user can configure the constant current charge safety timer via the CHG_TMR bit (REG08h, bits[2:1]) through the I²C. If the safety timer function is not used, it can be disabled by EN_TIMER (REG08h, bit[0]) via the I²C during initializing charger configuration.

The safety timer is reset at the beginning of a new charging cycle. Before the safety timer expires, any of the actions listed below can reset the safety timer:

- A new charge cycle begins by either input insertion or automatic recharge
- Toggling the CE pin low to high to low (charge enabled)
- Writing CHG_CONFIG (REG04h, bits[5:4]) from 00 to 01 (charge enabled)
- Writing EN_TIMER (REG08h, bit[0]) from 0 to 1 (safety timer enabled)

When safety timer expires, the safety timer fault bit (REG17h, bit[7]) is set to 1 and an INT is asserted to the host. Writing the BG_EN bit (REG09h, bit[3]) from 1 to 0 or re-inserting the input re-enables the input detection, clears the safety timer fault and restarts the safety timer.

The MP2731 automatically adjusts or suspends the timer if any fault occurs. The timer is suspended if any of the following conditions are met:

- Battery enters supplement mode and $V_{BATT} < V_{SYS_MIN}$
- Battery over-voltage protection (OVP) occurs
- NTC hot or cold fault occurs
- NTC floats
- Writing EN_TIMER (REG08h, bit[0]) from 1 to 0

The MP2731 provides a way to double the remaining time left on the timer, which is enabled by the TMR2X_EN bit. If the input current limit, input voltage regulation, or thermal regulation threshold is reached, the remaining time on the timer is doubled when TMR2X_EN is enabled. Once the device is cleared of the above conditions, the remaining time returns to the original setting.

The safety timer does not operate in USB OTG mode.

Watchdog Timer

The MP2731 is a host-controlled device, but it can operate in a default mode without host control. In default mode, all registers are in the default settings, and the WATCHDOG_FAULT command is set to 1.

In host-controlled mode, all the parameters can be configured by the host. To keep the device in host mode, the host has to periodically reset the watchdog timer by setting the WATCHDOG

TIMER RESET bit (REG08h, bit[3]) to 1 before the watchdog timer expires. If the watchdog timer expires, some of the registers will reset their values to default. See the I²C Register Map on page 29 to check which register is reset after the watchdog timer expires.

The following actions reset the watchdog timer and make the IC recover from a watchdog timer fault.

- Writing 1 to the WATCHDOG TIMER RESET bit (REG08h, bit[3])
- Toggling the WATCHDOG TIMER ENABLE bit (disable first, then enable)

Thermal Regulation and Thermal Shutdown

The MP2731 continuously monitors the internal junction temperature to maximize power delivery and avoid overheating the chip. If the internal junction temperature reaches the thermal regulation threshold (set by the T_{J_REG} bit), the MP2731 starts to reduce the charge current to prevent higher power dissipation. During thermal regulation, the THERM_STAT bit is set to 1.

If the junction temperature reaches thermal shutdown threshold T_{J_SHDN} (150°C), the MP2731 turns off the PWM step-down converter and BATFET. The THERMAL SHUTDOWN bit in the fault register is set to 1, and an INT signal is asserted to host. The step-down converter and BATFET resume normal operation when the junction temperature drops below the T_{J_SHDN} hysteresis threshold.

Battery Discharge Mode

If only the battery is connected, and V_{BATT} exceeds the V_{BATT_UVLO} threshold, then the battery FET turns on and connects the battery to the system. The 14mΩ battery FET minimizes the conduction loss during discharge. The MP2731’s quiescent current goes as low as 40µA. The low on resistance and low quiescent current help extend battery runtime.

There is an over-current limit designed in the MP2731 to avoid system over-current conditions while the battery discharges. If the discharge current exceeds this limit (I_{DSCHG_LMT}) after a 50µs blanking time, the discharge FET turns off and enters hiccup mode. After a 600ms recovery time, the discharge FET turns on again. If the discharge current goes high to reach the internal

fast-off current limit (14A), the battery FET turns off immediately and enters hiccup mode.

Battery Disconnection Function

In applications where the battery is not removable, it is essential to disconnect the battery from the system for shipping mode, or to allow the reset of system power during operation. The MP2731 provides both shipping mode and system reset mode for different applications.

The MP2731 can enter and exit shipping mode through I²C control of the BATFET_DIS bit (REG0Ah, bit[5]). Writing 1 to BATFET_DIS turns off the battery FET after a 10s delay. In battery discharge mode, the delay time is configured by the t_{SM_DLY} bit. Writing 0 to BATFET_DIS turns the battery FET on again.

In an application that requires a system power reset, the MP2731 uses a dedicated DISC pin to cut off the path from the battery to the system.

System reset function has two options, which can be selected via SYSRST_SEL bit (REG0Ah, bit[4]). If SYSRST_SEL is set to 1, once the logic at DISC is pulled low for more than 8s — programmable by the t_{DISC_L} bit (REG0Ah, bits[1:0]) — then the system is disconnected from the battery by turning off the battery FET. After a 4s low period, which can be programmed by t_{DISC_H} bit (REG0Ah, bits[3:2]), the battery FET automatically turn on (see Figure 8).

If the SYSRST_SEL bit (REG0Ah, bit[4]) is set to 0, and the logic at DISC is pulled low longer than the time programmed by the t_{DISC_L} bit, the battery FET turns off. Once the logic at DISC is pulled low again for time set by the t_{DISC_H} bit, the battery FET turns on (see Figure 9).

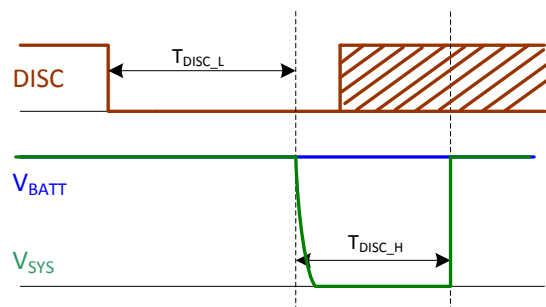

Figure 8: System Software Reset (SYSRST_SEL = 1)

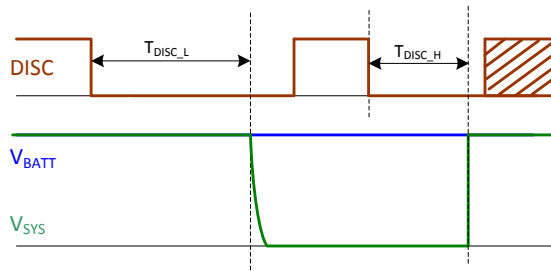

Figure 9: System Hardware Reset (SYSRST_SEL = 0)

OTG Boost Function

The MP2731 can supply a regulated 5V output at the IN pin to power the peripherals. This output is compliant with USB On-The-Go (OTG) specifications. The MP2731 does not enter OTG mode if the battery is below the battery under-voltage lockout (UVLO) threshold, to ensure that the battery is not drained. To enable OTG mode, the input voltage at the IN pin must be below 1.0V.

Boost operation can be enabled when the CHG_CONFIG bit = 11 (REG04h, bits[5:4] = 11) and the OTG pin is high. The OTG output current limit can be configured by the I_{IN_DSCHG} bit (REG03h, bits[1:0]) via the I²C. During boost mode, status register VIN_STAT (REG0Ch, bits[7:5]) changes to 111.

The following conditions must be met to enable boost operation:

- $V_{BATT} > V_{BATT_UVLO_OTG}$ (rising 3V)
- $V_{IN} < 1V$
- OTG pin is high and CHG_CONFIG (REG04h, bits[5:4]) is set to 11
- Boost mode is enabled after a 200ms delay

Once OTG is enabled, the MP2731 boosts the PMID to 5.0V. Then the block FET (Q1) is linearly regulated with a 3A output current limit. If V_{IN} is charged above 4.4V within 6ms, the block FET fully turns on. Otherwise, the block FET turns off, and the part goes into hiccup mode. After a 600ms off period, PMID tries to charge V_{IN} again.

The MP2731 provides OTG output short protection. If V_{IN} falls below 4.0V, the block FET and boost turn off, and the part enters hiccup mode. After a 600ms recovery time, OTG starts up again. When the OTG output is short, the fault register's OTG_FAULT bit (REG0Dh, bit[6]) is

set to 1, and an INT signal is sent to the host. The device also provides OTG output voltage protection. Once V_{IN} exceeds $V_{INOV_P_DSCHG}$, the MP2731 stops switching, the fault register OTG_FAULT bit (REG0Dh, bit[6]) is set to 1, and an INT signal is sent to the host.

In boost mode, the MP2731 employs a fixed, 1.35MHz, PWM step-up switching regulator. It switches from PWM operation to pulse-skip operation at light-load.

ADC

The MP2731 integrates an 8-bit ADC, which is available in charge mode and OTG mode. In charge mode, the ADC monitors input voltage, input current, system voltage, battery voltage, charge current and NTC voltage alternatively. In OTG mode, the ADC monitors battery voltage, system voltage, NTC voltage and input voltage. When ADC functionality is available, the ADC can be controlled by the ADC_START bit.

ADC operation has two modes, which can be selected by ADC_RATE. If ADC_RATE is set to 0, the ADC acts once an I²C command is issued. If ADC_RATE is set to 1, ADC always acts in a round-robin manner.

Series Interface

The IC uses an I²C-compatible interface to set the charging parameters and instantaneously report the device status. The I²C is a two-wire serial interface. Only two bus lines are required: a serial data line (SDA) and serial clock line (SCL). Both the SDA and SCL lines are open drains that must be connected to the positive supply voltage via a pull-up resistor.

The IC operates as a slave device and receives control inputs from the master device, such as a microcontroller. The SCL line is always driven by the master device. The I²C interface supports both standard mode (up to 100kbits/s) and fast mode (up to 400kbits/s).

All transactions begin with a start (S) condition and are terminated by a stop (P) condition. Start and stop conditions are always generated by the master. A start condition is defined as a high-to-low transition on the SDA line while SCL is high. A stop condition is defined as a low-to-high transition on the SDA line while the SCL is high (see Figure 10).

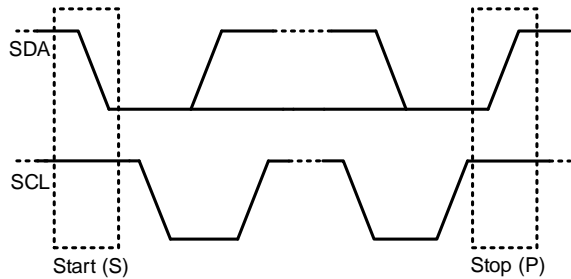

Figure 10: Start and Stop Conditions

For data validity, the data on the SDA line must be stable during the high period of the clock. The high or low state of the SDA line can only change when the clock signal on the SCL line is low (see Figure 11). Every byte on the SDA line must be 8 bits long. The number of bytes that can be transmitted per transfer is unrestricted. Data is first transferred with the most significant bit (MSB).

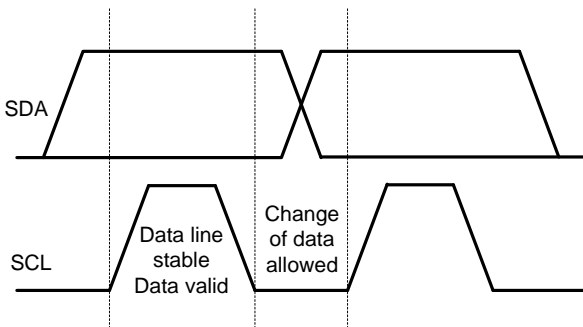

Figure 11: Bit Transfer on the I²C Bus

Each byte has to be followed by an acknowledge (ACK) bit, which is generated by the receiver to signal to the transmitter that the byte was successfully received.

The ACK signal occurs when the transmitter releases the SDA line during the acknowledge clock pulse. This allows the receiver to pull the SDA line low. The SDA line stays low during the high period of the ninth clock.

If the SDA line is high during the ninth clock, this is defined as a not acknowledge (NACK) signal. The master can then generate either a stop condition to abort the transfer or a repeated start (Sr) condition to start a new transfer.

After the start condition, a slave address is sent. This address is 7 bits long, followed by the 8th data direction bit (R/W). A 0 indicates a transmission (write), and a 1 indicates a request for data (read). Figure 12 shows the address bit arrangement.

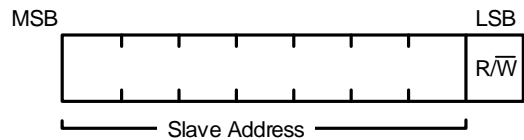

Figure 12: 7-Bit Addressing

See Figure 13, Figure 14, Figure 15, Figure 16, and Figure 17 on page 27 for detailed sequences.

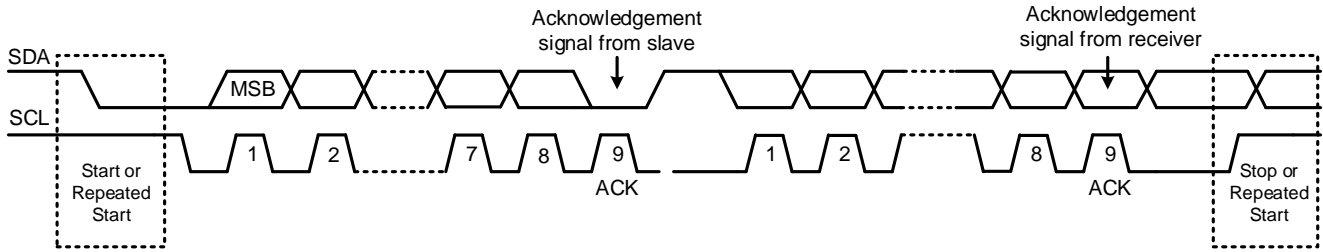

Figure 13: Data Transfer on the I²C Bus

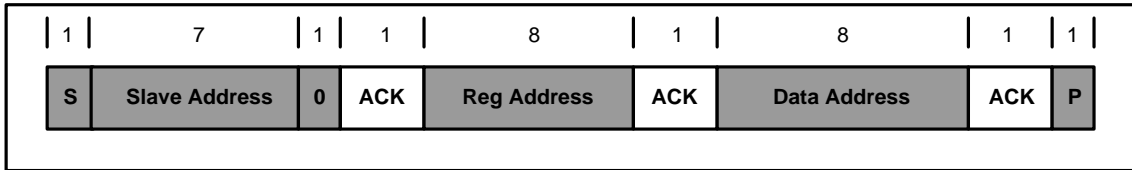

Figure 14: Single Write

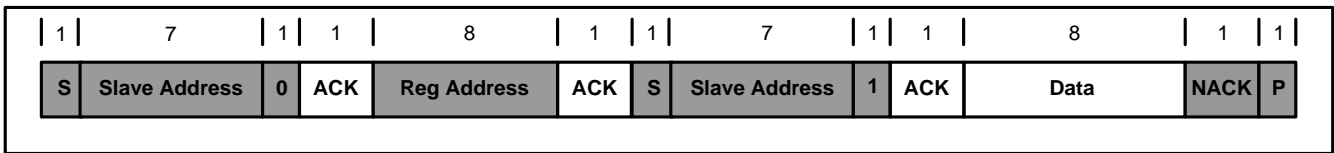

Figure 15: Single Read

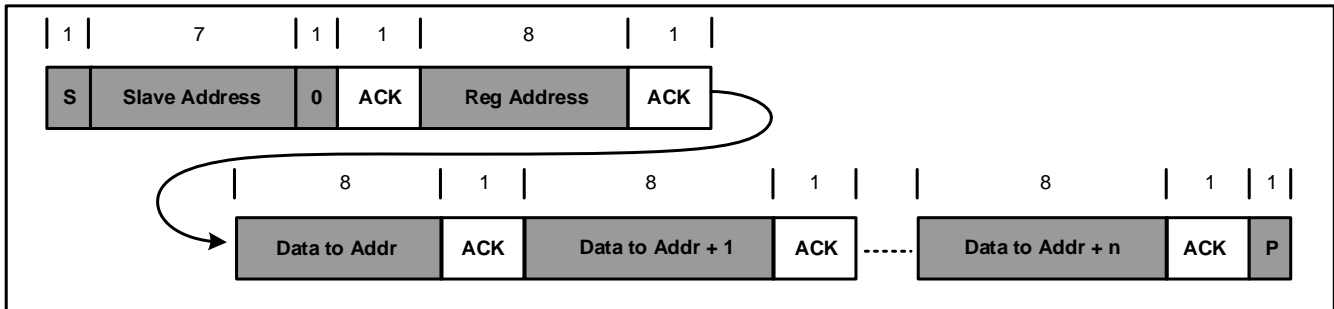

Figure 16: Multi Write

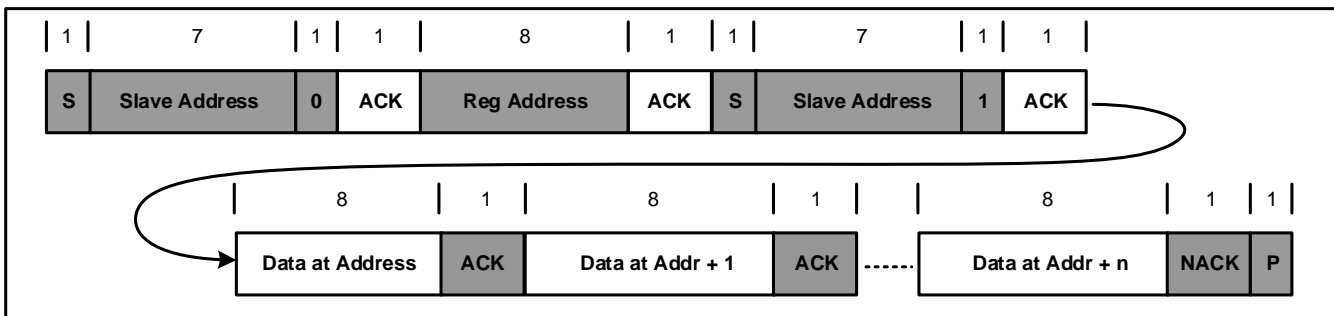

Figure 17: Multi Read

I²C REGISTER MAP

IC Address 4Bh Register Name	Address	R/W	Description
REG00h	0x00	R/W	Input current limit.
REG01h	0x01	R/W	Input voltage regulation.
REG02h	0x02	R/W	NTC configuration and thermal regulation.
REG03h	0x03	R/W	ADC control and OTG configuration.
REG04h	0x04	R/W	Charge control and VSYS configuration.
REG05h	0x05	R/W	Charge current configuration.
REG06h	0x06	R/W	Pre-charge and termination current.
REG07h	0x07	R/W	Charge voltage regulation.
REG08h	0x08	R/W	Timer configuration.
REG09h	0x09	R/W	Bandgap.
REG0Ah	0x0A	R/W	BATFET configuration.
REG0Bh	0x0B	R/W	INT MASK and USB detection
REG0Ch	0x0C	R	Status.
REG0Dh	0x0D	R	Fault.
REG0Eh	0x0E	R	ADC of battery voltage.
REG0Fh	0x0F	R	ADC of system voltage.
REG10h	0x10	R	ADC of NTC voltage.
REG11h	0x11	R	ADC of input voltage.
REG12h	0x12	R	ADC of charge current.
REG13h	0x13	R	ADC of input current.
REG14h	0x14	R	Power management status.
REG15h	0x15	R/W	DPM mask.
REG16h	0x16	R/W	JEITA configuration.
REG17h	0x17	R	Safety timer status and part number.

REG00h: Input Current Limit

Bit	Name	POR	Reset by REG_RST	Reset by WTD	R/W	Description	Comment
7	EN_HIZ	0	Y	Y	R/W	0: Disable 1: Enable	Hi-Z mode enable bit. Set to 0 by default. This bit only turns off the DC/DC converter.
6	EN_LIM	1	Y	Y	R/W	0: Disable 1: Enable	Enable bit for the ILIM pin. This bit is set to 1 by default. The charger input current limit is the lower value between the IIN_LIM register setting and ILIM pin setting.
5	IIN_LIM[5]	0	Y	N	R/W	1600mA	This bit sets the input current limit threshold. It has a 100mA offset, a 500mA default, and a 100mA to 3.25A range via the one-time programmable (OTP) memory. V _{IN} POR can reset IIN_LIM to the default via the OTP.
4	IIN_LIM[4]	0	Y	N	R/W	800mA	
3	IIN_LIM[3]	1	Y	N	R/W	400mA	
2	IIN_LIM[2]	0	Y	N	R/W	200mA	
1	IIN_LIM[1]	0	Y	N	R/W	100mA	
0	IIN_LIM[0]	0	Y	N	R/W	50mA	

REG01h: Input Voltage Regulation

Bit	Name	POR	Reset by REG_RST	Reset by WTD	R/W	Description	Comment
7	REGISTER RESET	0	Y	N	R/W	0: Keep current setting 1: Reset	This bit is set to 0 by default.
6	V _{IN_MIN} [6]	0	Y	N	R/W	6400mV	This bit sets the input voltage limit threshold. It has a 3.7V offset, 3.7V to 15.2V range, and is set to 0000110 (4.3V) by default via the OTP. V _{IN} POR can reset V _{IN_MIN} to its default value via the OTP.
5	V _{IN_MIN} [5]	0	Y	N	R/W	3200mV	
4	V _{IN_MIN} [4]	0	Y	N	R/W	1600mV	
3	V _{IN_MIN} [3]	0	Y	N	R/W	800mV	
2	V _{IN_MIN} [2]	1	Y	N	R/W	400mV	
1	V _{IN_MIN} [1]	1	Y	N	R/W	200mV	
0	V _{IN_MIN} [0]	0	Y	N	R/W	100mV	

REG02h: NTC Configuration and Thermal Regulation

Bit	Name	POR	Reset by REG_RST	Reset by WTD	R/W	Description	Comment
7	t _{SM_DLY}	1	Y	Y	R/W	0: No delay 1: 10s delay	This bit sets the shipping mode entry delay time. It is set to 1 by default.
6	NTC_TYPE	1	Y	Y	R/W	0: Standard 1: JEITA	This bit is set to 1 by default.
5	EN_OTG NTC	0	Y	Y	R/W	0: Disabled 1: Enabled	OTG NTC enable bit. This bit is set to 0 by default.
4	EN_CHG NTC	1	Y	Y	R/W	0: Disabled 1: Enabled	Charge NTC enable bit. This bit is set to 1 by default.
3	T _{J_REG} [1]	1	Y	Y	R/W	00: 60°C 01: 80°C 10: 100°C 11: 120°C	Thermal regulation threshold. This bit is set to 11 by default.
2	T _{J_REG} [0]	1	Y	Y	R/W		
1	NTC OPT	0	Y	Y	R/W	0: Battery OTP 1: PCB OTP	NTC option selection bit. This bit is set to 0 by default.
0	AICO_EN	0	Y	N	R/W	0: Disable AICO 1: Enable AICO	Automatic input current optimization enable bit. This bit is set to 0 by default.

REG03h: ADC Control and OTG Configuration

Bit	Name	POR	Reset by REG_RST	Reset by WTD	R/W	Description	Comment
7	ADC_START	0	Y	Y	R/W	0: Disable ADC 1: Enable ADC	ADC enable bit. Set to 0 by default. This bit is read-only when ADC_RATE = 1. This bit stays high during ADC conversion.
6	ADC_RATE	0	Y	Y	R/W	0: One-shot conversion 1: Start continuous conversion	This bit sets the ADC conversion rate. This bit is set to 0 by default.
5	V _{IN_DSCHG} [2]	0	Y	Y	R/W	400mV	This bit sets the On-the-Go (OTG) voltage. The offset is 4.8V, the default is 5.0V (010), and the range is 4.8V to 5.5V.
4	V _{IN_DSCHG} [1]	1	Y	Y	R/W	200mV	
3	V _{IN_DSCHG} [0]	0	Y	Y	R/W	100mV	
2	I _{IN_DSCHG} [2]	0	Y	Y	R/W	000: 0.5A 001: 0.8A 010: 1.1A 011: 1.5A 100: 1.8A 101: 2.1A 110: 2.4A 111: 3.0A	This bit sets the On-the-Go (OTG) current limit. Set to 000 by default.
1	I _{IN_DSCHG} [1]	0	Y	Y	R/W		
0	I _{IN_DSCHG} [0]	0	Y	Y	R/W		

REG04h: Charge Control and VSYS Configuration

Bit	Name	POR	Reset by REG_RST	Reset by WTD	R/W	Description	Comment
7	BAT_LOADEN	0	Y	Y	R/W	0: Disable I _{BATLOAD} 1: Enable I _{BATLOAD}	Battery load enable bit. Set to 0 by default.
6	STAT_EN	1	Y	Y	R/W	0: Disabled 1: Enabled	STAT pin enable bit. Set to 1 by default.
5	CHG CONFIG [1]	0	Y	Y	R/W	00: Charge disabled 01: Charge enabled 10: Reserved 11: On-the-Go (OTG)	Charge configuration bit. Set to 01 by default.
4	CHG CONFIG [0]	1	Y	Y	R/W		
3	V _{SYSTMIN} [2]	1	Y	N	R/W	000: 3V 001: 3.15 010: 3.3V 011: 3.45V 100: 3.525V 101: 3.6V 110: 3.675V 111: 3.75V	This bit sets the minimum system voltage. It has 3V to 3.75V range, and is set to 101 by default.
2	V _{SYSTMIN} [1]	0	Y	N	R/W		
1	V _{SYSTMIN} [0]	1	Y	N	R/W		
0	V _{TRACK} [0]	1	Y	N	R/W	0: 100mV 1: 150mV	Battery track voltage bit. Set to 1 by default.

REG05h: Charge Current Configuration

Bit	Name	POR	Reset by REG_RST	Reset by WTD	R/W	Description	Comment
7	V _{BATTPRE}	1	Y	Y	R/W	0: 2.8V 1: 3.0V	This bit sets the pre-charge to fast charge threshold. It is set to 1 by default.
6	I _{CC} [6]	0	Y	Y	R/W	2560mA	This bit sets the fast charge current. It has a 320mA offset, 320mA to 4520mA range, and is set to 0100110 (1840mA) by default.
5	I _{CC} [5]	1	Y	Y	R/W	1280mA	
4	I _{CC} [4]	0	Y	Y	R/W	640mA	
3	I _{CC} [3]	0	Y	Y	R/W	320mA	
2	I _{CC} [2]	1	Y	Y	R/W	160mA	
1	I _{CC} [1]	1	Y	Y	R/W	80mA	
0	I _{CC} [0]	0	Y	Y	R/W	40mA	

REG06h: Pre-Charge and Termination Current

Bit	Name	POR	Reset by REG_RST	Reset by WTD	R/W	Description	Comment
7	IPRE [3]	0	Y	Y	R/W	320mA	This bit sets the pre-charge current. It has a 150mA offset, 150mA to 750mA range, and is set to 0010 (230mA) by default.
6	IPRE [2]	0	Y	Y	R/W	160mA	
5	IPRE [1]	1	Y	Y	R/W	80mA	
4	IPRE [0]	0	Y	Y	R/W	40mA	
3	ITERM [3]	0	Y	Y	R/W	320mA	This bit sets the termination current. It has a 120mA offset, 120mA to 720mA range, and is set to 0010 (200mA) by default.
2	ITERM [2]	0	Y	Y	R/W	160mA	
1	ITERM [1]	1	Y	Y	R/W	80mA	
0	ITERM [0]	0	Y	Y	R/W	40mA	

REG07h: Charge Voltage Regulation

Bit	Name	POR	Reset by REG_RST	Reset by WTD	R/W	Description	Comment
7	VBATT_REG [5]	1	Y	Y	R/W	640mV	This bit sets the battery regulation voltage. It has a 3.4V offset, 3.4V to 4.67V range, and is set to 1010000 (4.2V) by default.
6	VBATT_REG [5]	0	Y	Y	R/W	320mV	
5	VBATT_REG [4]	1	Y	Y	R/W	160mV	
4	VBATT_REG [3]	0	Y	Y	R/W	80mV	
3	VBATT_REG [2]	0	Y	Y	R/W	40mV	
2	VBATT_REG [1]	0	Y	Y	R/W	20mV	
1	VBATT_REG [0]	0	Y	Y	R/W	10mV	
0	VRECH	0	Y	Y	R/W	0: 100mV 1: 200mV	This bit sets the battery recharge threshold (below VBATT_REG). Set to 0 by default.

REG08h: Timer Configuration

Bit	Name	POR	Reset by REG_RST	Reset by WTD	R/W	Description	Comment
7	EN_TERM	1	Y	Y	R/W	0: Disabled 1: Enabled	Termination enable bit. Set to 1 by default.
6	RESERVED	N/A	N/A	N/A	N/A	Reserved.	
5	WATCHDOG [1]	0	Y	N	R/W	00: Disable timer 01: 40s 10: 80s 11: 160s	This bit sets the I ² C watchdog timer limit. Set to 01 by default. The watchdog function is not available when only a battery is present.
4	WATCHDOG [0]	1	Y	N	R/W		
3	WATCHDOG TIMER RESET	0	Y	Y	R/W	0: Normal 1: Reset	This bit is set to 0 by default, and returns to 0 after the timer resets.
2	CHG_TMR [1]	1	Y	Y	R/W	00: 5hrs 01: 8hrs 10: 12hrs 11: 20hrs	Constant current charge timer. This bit is set to 10 by default via the OTP.
1	CHG_TMR [2]	0	Y	Y	R/W		
0	EN_TIMER	1	Y	Y	R/W	0: Disabled 1: Enabled	Safety timer enable bit. Set to 1 by default.

REG09h: Bandgap

Bit	Name	POR	Reset by REG_RST	Reset by WTD	R/W	Description	Comment
7	RESERVED	N/A	N/A	N/A	N/A	Reserved.	
6	RESERVED	N/A	N/A	N/A	N/A	Reserved.	
5	RESERVED	N/A	N/A	N/A	N/A	Reserved.	
4	RESERVED	N/A	N/A	N/A	N/A	Reserved.	
3	BG_EN	0	Y	Y	R/W	0: Enabled 1: Disabled	This bit is set to 0 by default. Setting this bit from 1 to 0 will reset the input plug-in detection and safety timer.
2	RESERVED	N/A	N/A	N/A	N/A	Reserved.	
1	RESERVED	N/A	N/A	N/A	N/A	Reserved.	
0	RESERVED	N/A	N/A	N/A	N/A	Reserved.	

REG0Ah: BATFET Configuration

Bit	Name	POR	Reset by REG_RST	Reset by WTD	R/W	Description	Comment
7	SW FREQ	0	Y	Y	R/W	0: 1.35MHz 1: 1MHz	This bit sets the switching frequency. Set to 0 by default.
6	TMR2X_EN	1	Y	Y	R/W	0: Disable 2x extended safety timer 1: Enable 2x extended safety timer	2x timer enable bit. Set to 1 by default.
5	BATFET_DIS	0	N	N	R/W	0: Allow BATFET to turn on 1: Force BATFET off	This bit is set to 0 by default.
4	SYSRST_SEL	1	Y	N	R/W	0: Hardware reset 1: Software reset	System reset selection bit. If hardware is selected, pull DISC low for time in Bit[1:0] to turn off BATFET, pull DISC low for time in Bit[3:2] to turn on BATFET. If software reset is selected, the off time is set by bits[3:2]. Set this bit to 1 by default.
3	t _{disc_h} [1]	1	Y	Y	R/W	00: 0.5s 01: 2s	DISC pin pull low time or BATFET off time to reset BATFET. This bit is set to 10 by default.
2	t _{disc_h} [0]	0	Y	Y	R/W	10: 4s 11: 8s	
1	t _{disc_l} [1]	0	Y	Y	R/W	00: 8s 01: 10s	DISC pin pull low lasting time to turn off BATFET. This bit is set to 00 by default.
0	t _{disc_l} [0]	0	Y	Y	R/W	10: 12s 11: 16s	

REG0Bh: INT MASK and USB Detection

Bit	Name	POR	Reset by REG_RST	Reset by WTD	R/W	Description	Comment
7	INT_MASK [1]	1	Y	Y	R/W	0: No INT during safety timer fault 1: INT during safety timer fault	This bit is set to 1 by default.
6	INT_MASK [0]	1	Y	Y	R/W	0: No INT during BAT_FAULT 1: INT in BAT_FAULT	This bit is set to 1 by default.
5	USB_DET_EN	0	Y	Y	R/W	0: Not in DP/DM detection 1: Force DP/DM detection	USB DP/DM detection enable bit. Set to 0 by default.
4	DM	0	Y	N	R/W	0: 3.3V 1: 0.6V	This bit is set to 0 by default, and is valid when REG0Bh, bits[2:1] = 11. It resets to 0 after 1 is written.
3	DP	0	Y	N	R/W	0: 0.6V 1: 3.3V	This bit is set to 0 by default, and is valid when REG0Bh, bits[2:1] = 11. It resets to 0 after 1 is written.
2	USB FAST CHG [1]	0	Y	N	R/W	00: DP = 0.6V, DM = Hi-Z 01: DP = 3.3V, DM = 0.6V 10: DP = 0.6V, DM = 0.6V 11: DP = 0.6V, DM = 3.3V	This bit sets the fast charge value. Set to 00 by default. After V _{IN} POR, these bits go back to 00.
1	USB FAST CHG [0]	0	Y	N	R/W		
0	USB FAST CHG_RESET	0	Y	N	R/W	0: D+ recovers to V _{DP_SRC} 1: D+ is pulled down to zero	This bit resets USB fast charge by forcing the DP pin to 0V. Set to 0 by default. This bit is valid in fast charge mode.

REG0Ch: STATUS

Bit	Name	POR	Reset by REG_RST	Reset by WTD	R/W	Description	Comment
7	VIN_STAT[2]	0	N	N	R	D+/D- version 000: No input 001: Nonstandard adapter (1A/2.1A/2.4A) 010: SDP 011: CDP 100: DCP 101: Fast-charge adapter 111: OTG	This bit selects the input source. Set to 000 by default. VIN POR resets VIN_STAT.
6	VIN_STAT[1]	0	N	N	R		
5	VIN_STAT[0]	0	N	N	R		
4	CHG_STAT [1]	0	N	N	R	00: Not charging 01: Trickle charge 10: Constant current charge 11: Charge done	This bit is set to 00 by default.
3	CHG_STAT [0]	0	N	N	R		
2	NTC FLOAT_STAT	0	N	N	R	0: No NTC float 1: NTC float	This bit is set to 0 by default.
1	THERM_STAT	0	N	N	R	0: Normal 1: Thermal regulation	This bit is set to 0 by default.
0	VSYS_STAT	1	N	N	R	0: In V _{SYSMIN} regulation (BAT < V _{SYSMIN}) 1: Not in V _{SYSMIN} regulation (BAT > V _{SYSMIN})	This bit is set to 1 by default.

REG0Dh: FAULT

Bit	Name	POR	Reset by REG_RST	Reset by WTD	R/W	Description	Comment
7	WATCHDOG_FAULT	0	N	N	R	0: Normal 1: Watchdog timer expiration	This bit is set to 0 by default.
6	OTG_FAULT	0	N	N	R	0: Normal 1: V _{IN} overload, or V _{IN} over-voltage protection (OVP), or the battery has an under-voltage condition	This bit is set to 0 by default.
5	INPUT_FAULT	0	N	N	R	0: Normal 1: Input over-voltage protection (OVP) or no input	This bit is set to 0 by default.
4	THERMAL_SHUTDOWN	0	N	N	R	0: Normal 1: Thermal shutdown	This bit is set to 0 by default.
3	BAT_FAULT	0	N	N	R	0: Normal 1: Battery over-voltage protection (OVP)	This bit is set to 0 by default.
2	NTC_FAULT [2]	0	N	N	R	Buck mode 000: Normal 010: NTC warm 011: NTC cool 101: NTC cold 110: NTC hot Boost mode 000: Normal 101: NTC cold 110: NTC hot	This bit is set to 000 by default.
1	NTC_FAULT [1]	0	N	N	R		
0	NTC_FAULT [0]	0	N	N	R		

REG0Eh: ADC of Battery Voltage

Bit	Name	POR	Reset by REG_RST	Reset by WTD	R/W	Description	Comment
7	VBATT[7]	0	N	N	R	2560mV	This bit sets the ADC conversion of the battery cell voltage. It has a 0V offset and a 0V to 5.1V range.
6	VBATT[6]	0	N	N	R	1280mV	
5	VBATT[5]	0	N	N	R	640mV	
4	VBATT[4]	0	N	N	R	320mV	
3	VBATT[3]	0	N	N	R	160mV	
2	VBATT[2]	0	N	N	R	80mV	
1	VBATT[1]	0	N	N	R	40mV	
0	VBATT[0]	0	N	N	R	20mV	

REG0Fh: ADC of System Voltage

Bit	Name	POR	Reset by REG_RST	Reset by WTD	R/W	Description	Comment
7	VSYS[7]	0	N	N	R	2560mV	This bit sets the ADC conversion of the system voltage. It has a 0V offset and 0V to 5.1V range.
6	VSYS[6]	0	N	N	R	1280mV	
5	VSYS[5]	0	N	N	R	640mV	
4	VSYS[4]	0	N	N	R	320mV	
3	VSYS[3]	0	N	N	R	160mV	
2	VSYS[2]	0	N	N	R	80mV	
1	VSYS[1]	0	N	N	R	40mV	
0	VSYS[0]	0	N	N	R	20mV	

REG10h: ADC of NTC Voltage

Bit	Name	POR	Reset by REG_RST	Reset by WTD	R/W	Description	Comment
7	NTC[7]	0	N	N	R	50.176%	This bit sets the ADC conversion of the NTC voltage. It has a 0% offset and 0% to 100% range.
6	NTC[6]	0	N	N	R	25.088%	
5	NTC[5]	0	N	N	R	12.544%	
4	NTC[4]	0	N	N	R	6.272%	
3	NTC[3]	0	N	N	R	3.136%	
2	NTC[2]	0	N	N	R	1.568%	
1	NTC[1]	0	N	N	R	0.784%	
0	NTC[0]	0	N	N	R	0.392%	

REG11h: ADC of Input Voltage

Bit	Name	POR	Reset by REG_RST	Reset by WTD	R/W	Description	Comment
7	VIN[7]	0	N	N	R	7680mV	The bit sets the ADC conversion of the input voltage. It has a 0V offset and a 3.6V to 15.3V range.
6	VIN[6]	0	N	N	R	3840mV	
5	VIN[5]	0	N	N	R	1920mV	
4	VIN[4]	0	N	N	R	960mV	
3	VIN[3]	0	N	N	R	480mV	
2	VIN[2]	0	N	N	R	240mV	
1	VIN[1]	0	N	N	R	120mV	
0	VIN[0]	0	N	N	R	60mV	

REG12h: ADC of Charge Current

Bit	Name	POR	Reset by REG_RST	Reset by WTD	R/W	Description	Comment
7	I _{CHG} [7]	0	N	N	R	2240mA	The bit sets the ADC conversion of the charge current. It has a 0A offset and a 0A to 5.66A range.
6	I _{CHG} [6]	0	N	N	R	1120mA	
5	I _{CHG} [5]	0	N	N	R	560mA	
4	I _{CHG} [4]	0	N	N	R	280mA	
3	I _{CHG} [3]	0	N	N	R	140mA	
2	I _{CHG} [2]	0	N	N	R	70mA	
1	I _{CHG} [1]	0	N	N	R	35mA	
0	I _{CHG} [0]	0	N	N	R	17.5mA	

REG13h: ADC of Input Current

Bit	Name	POR	Reset by REG_RST	Reset by WTD	R/W	Description	Comment
7	I _{IN} [7]	0	N	N	R	1702.4mA	This bit sets the ADC conversion of the input current. It has a 0A offset and a 0A to 3.39A range.
6	I _{IN} [6]	0	N	N	R	851.2mA	
5	I _{IN} [5]	0	N	N	R	425.6mA	
4	I _{IN} [4]	0	N	N	R	212.8mA	
3	I _{IN} [3]	0	N	N	R	106.4mA	
2	I _{IN} [2]	0	N	N	R	53.2mA	
1	I _{IN} [1]	0	N	N	R	26.6mA	
0	I _{IN} [0]	0	N	N	R	13.3mA	

REG14h: Power Management Status

Bit	Name	POR	Reset by REG_RST	Reset by WTD	R/W	Description	Comment
7	VINPPM_STAT	0	N	N	R	0: No PPM 1: VINPPM	This bit is set to 0 by default.
6	IINPPM_STAT	0	N	N	R	0: No PPM 1: IINPPM	This bit is set to 0 by default.
5	I _{IN_DPM} [5]	0	N	N	R	1600mA	The bit has a 100mA offset, a 100mA to 3.25A range, and is 001000 by default.
4	I _{IN_DPM} [4]	0	N	N	R	800mA	
3	I _{IN_DPM} [3]	1	N	N	R	400mA	
2	I _{IN_DPM} [2]	0	N	N	R	200mA	
1	I _{IN_DPM} [1]	0	N	N	R	100mA	
0	I _{IN_DPM} [0]	0	N	N	R	50mA	

REG15h: DPM Mask

Bit	Name	POR	Reset by REG_RST	Reset by WTD	R/W	Description	Comment
7	AICO_STAT	0	N	N	R	0: No operation 1: AICO action	This bit is set to 0 by default.
6	VINPPM_INT_MASK[1]	1	Y	Y	R/W	0: No INT during VINPPM 1: INT during VINPPM	This bit is set to 1 by default.
5	IINPPM_INT_MASK[1]	1	Y	Y	R/W	0: No INT during IINPPM 1: INT during IINPPM	This bit is set to 1 by default.
4	RESERVED	N/A	N/A	N/A	N/A	Reserved.	
3	RESERVED	N/A	N/A	N/A	N/A	Reserved.	
2	RESERVED	N/A	N/A	N/A	N/A	Reserved.	
1	RESERVED	N/A	N/A	N/A	N/A	Reserved.	
0	RESERVED	N/A	N/A	N/A	N/A	Reserved.	

REG16h: JEITA Configuration

Bit	Name	POR	Reset by REG_RST	Reset by WTD	R/W	Description	Comment
7	JEITA_VSET	1	Y	Y	R/W	0: V _{BATT_REG} minus 100mV 1: V _{BATT_REG} minus 200mV	This bit is set to 1 by default.
6	JEITA_ISET	1	Y	Y	R/W	0: 50% of I _{CHG} 1: 16.7% of I _{CHG}	This bit is set to 1 by default.
5	V _{TH_HOT}	1	Y	Y	R/W	0: 34.0% (60°C) 1: 36.0% (55°C)	This bit sets the hot threshold. Set to 1 by default. The thermistor is 103AT.
4	V _{TH_WARM} [1]	0	Y	Y	R/W	00: 43.0% (40°C) 01: 40.0% (45°C) 10: 38.0% (50°C) 11: 36.0% (55°C)	This bit sets the warm threshold. Set to 01 by default. The thermistor is 103AT.
3	V _{TH_WARM} [0]	1	Y	Y	R/W		
2	V _{TH_COOL} [1]	1	Y	Y	R/W	00: 72.0% (0°C) 01: 68.0% (5°C) 10: 64.0% (10°C) 11: 60.0% (15°C)	This bit sets the cool threshold. Set to 11 by default. The thermistor is 103AT.
1	V _{TH_COOL} [0]	1	Y	Y	R/W		
0	V _{TH_COLD}	0	Y	Y	R/W	0: 72.0% (0°C) 1: 68% (5°C)	This bit sets the cold threshold. Set to 0 by default. The thermistor is 103AT.

REG17h: Safety Timer Status and Part Number

Bit	Name	POR	Reset by REG_RST	Reset by WTD	R/W	Description	Comment
7	SAFETY TIMER	0	N	N	R	0: Normal 1: Safety timer expiration	This bit is set to 0 by default.
6	RESERVED	N/A	N/A	N/A	N/A	Reserved.	
5	PN[2]	0	N	N	R	000: MP2731	This bit is set to 000 by default.
4	PN[1]	0	N	N	R		
3	PN[0]	0	N	N	R		
2	RESERVED	N/A	N/A	N/A	N/A	Reserved.	
1	RESERVED	N/A	N/A	N/A	N/A	Reserved.	
0	RESERVED	N/A	N/A	N/A	N/A	Reserved.	

REG18h ⁽⁷⁾

Bit	Name	POR	Reset by REG_RST	Reset by WTD	R/W	Description	Comment
7	IINLIM/VINMIN RESET_EN	0	N	N	N	0: IIN_LIM and VIN_MIN do not reset when VIN POR 1: IIN_LIM and VIN_MIN reset when VIN POR	This bit is set to 0 by default.
6	RESERVED	N/A	N/A	N/A	N/A	Reserved.	
5	RESERVED	N/A	N/A	N/A	N/A	Reserved.	
4	RESERVED	N/A	N/A	N/A	N/A	Reserved.	
3	VINOVP_CS	0	N/A	N/A	N/A	0: 16.8V 1: As per USB FAST CHG[1:0] setting	This bit is set to 0 by default.
2	ADDRESS	0	N/A	N/A	N/A	0: 4BH 1: 21H	This bit is set to 0 by default.
1	PFM_EN	0	N/A	N/A	N/A	0: Enable 1: Disable	This bit is used to enable or disable PFM when charging is disabled. Set to 0 by default.
0	RESERVED	N/A	N/A	N/A	N/A	Reserved.	

Note:

7) This register is for the one-time programmable (OTP) memory. It is not accessible.

OTP MAP

#	Bit7	Bit6	Bit5	Bit4	Bit3	Bit2	Bit1	Bit0
00	N/A		I _{IN_LIM} : 100mA to 3250mA/50mA step					
01	N/A	V _{IN_MIN} : 3.7V to 15.2V/100mV step						
05	N/A	I _{CC} : 320mA to 4520mA/40mA step						
07	V _{BATT_REG} : 3.4V to 4.67V/10mV step							N/A
08	N/A					CHG_TMR		N/A
18	I _{INLIM} /V _{INMIN} RESET_EN	N/A	N/A	N/A	V _{INOVP_CS}	ADDRESS	PFM_EN	N/A

OTP DEFAULT

OTP Items	Default
I _{IN_LIM}	500mA
V _{IN_MIN}	4.3V
I _{CC}	1.84A
V _{BATT_REG}	4.2V
CHG_TMR	12hrs
INLIM/VINMIN RESET_EN	I _{IN_LIM} and V _{IN_MIN} not reset when VIN POR
V _{INOVP_CS}	16.8V
ADDRESS	4BH
PFM_EN	Enable

APPLICATION INFORMATION

Setting the Input Current Limit

The input current limit is set according to the input power source. The input current limit can be set through the I²C using the MP2731's GUI. If a user wants to set a current limit that cannot be set by the I²C, it can be set using the ILIM pin. Connect a resistor from the ILIM pin to AGND to program the input current limit. The MP2731 selects the lower limit between the I²C setting and the resistor setting. The ILIM pin resistor can be determined with Equation (1) on page 22.

See Table 1 on page 22 to determine how to set the input current limit for USB inputs.

Selecting the Inductor

Inductor selection is a tradeoff between cost, size, and efficiency. A smaller-value inductor is physically small, but results in higher ripple current, magnetic hysteric loss, and output capacitance. A larger-value inductance provides lower ripple current and smaller output filter capacitors, but results in higher inductor DC resistance (DCR) loss.

For the best results, the inductor ripple current should not exceed 30% of the maximum load current under the worst-case conditions. For the MP2731 to operate with a typical 5V input voltage, the maximum inductor current ripple occurs at the corner point between pre-charge and constant current charge. The inductance (L) can be estimated with Equation (2):

$$L = \frac{V_{IN} - V_{SYS}}{\Delta I_{L_MAX}} \frac{V_{SYS}}{V_{IN} \times f_{SW}} (\mu\text{H}) \quad (2)$$

Where V_{IN} is the input voltage, V_{SYS} is the system voltage, f_{SW} is the switching frequency, and ΔI_{L_MAX} is the maximum inductor ripple current, which is usually 30% of the CC charge current.

I_{PEAK} can be calculated with Equation (3):

$$I_{PEAK} = I_{LOAD(MAX)} \times \left(1 + \frac{\%ripple}{2}\right) (A) \quad (3)$$

The maximum charge current can be set to 4.5A, but the real charge current cannot reach this value due to the input current limit. To cover most typical applications, and to give enough margin to avoid reaching the peak current limit of the high-side switch, the maximum inductor current ripple is set to 0.5A with $5V_{IN}$, and the inductance is 1.5 μ H. Select 1.0 μ H for low-profile

operation. To optimize efficiency, choose an inductor with a low DC resistance.

Selecting the Input Capacitor

The step-down converter has a discontinuous input current, and requires a capacitor to supply the AC current to the converter while maintaining the DC input voltage. Use low-ESR capacitors for the best performance. Ceramic capacitors are recommended, but tantalum or low-ESR electrolytic capacitors are sufficient. Choose ceramic capacitors with X5R or X7R dielectrics.

Since the input capacitor (C_{IN}) absorbs the input switching current, it requires an adequate ripple current rating. The RMS current in the input capacitor can be estimated with Equation (4):

$$I_{CIN} = I_{LOAD} \times \sqrt{\frac{V_{SYS}}{V_{IN}} \times \left(1 - \frac{V_{SYS}}{V_{IN}}\right)} \quad (4)$$

The worst-case condition occurs when $V_{IN} = 2V_{SYS}$, and $I_{CIN} = I_{SYS} / 2$. For simplification, choose the input capacitor with an RMS current rating that exceeds half of the maximum load current.

For the MP2731, the RMS current in the input capacitor is from PMID to GND. This means a small, high-quality ceramic capacitor (e.g. 10 μ F) should be placed from VPMID to PGND, as close to the IC as possible. The remaining capacitor should be placed from VIN to GND.

When using ceramic capacitors, ensure that they have enough capacitance to provide sufficient charge that prevents excessive voltage ripple at the input.

Selecting the Output Capacitor

In the typical application circuit, the output capacitor (C_{SYS}) is in parallel with the SYS load. C_{SYS} absorbs the high-frequency switching ripple current and smooths the output voltage. Its impedance must be below that of the system load to ensure that it properly absorbs the ripple current.

It is recommended to use a ceramic capacitor because its lower ESR and smaller size allow the ESR of the output capacitor to be ignored.

The output voltage ripple can be calculated with Equation (5):

$$\Delta R = \frac{\Delta V_{SYS}}{V_{SYS}} = \frac{1 - \frac{V_{SYS}}{V_{IN}}}{8 \times C_{SYS} \times f_{SW}^2 \times L} \% \quad (5)$$

To guarantee the $\pm 0.5\%$ system voltage accuracy, the maximum output voltage ripple must not exceed 0.5% (e.g. 0.1%). The maximum output voltage ripple occurs at the minimum system voltage and the maximum input voltage.

The output capacitor can be calculated with Equation (6):

$$C_{SYS} = \frac{1 - \frac{V_{SYS}}{V_{IN}}}{8 \times f_{SW}^2 \times L \times \Delta R} \quad (6)$$

For example, if $V_{IN} = 5V$, $V_{SYS} = 3.7V$, $L = 1\mu H$, $f_{SW} = 1.35MHz$, and $\Delta R = 0.1\%$, choose a 22 μF ceramic capacitor.

Selecting the NTC Resistor

Figure 6 on page 23 shows an external resistor divider reference circuit to limit the low-temperature threshold (V_{COLD}) and high-temperature threshold (V_{HOT}). For a given NTC thermistor, select the appropriate R_{T2} and R_{T1} values to set the NTC window, calculated with Equation (7) and Equation (8), respectively:

$$R_{T2} = \frac{R_{NTC_HOT} \times V_{COLD} \times (1 - V_{HOT}) - R_{NTC_COLD} \times V_{HOT} \times (1 - V_{COLD})}{V_{HOT} - V_{COLD}} \quad (7)$$

$$R_{T1} = \frac{(1 - V_{COLD}) \times (R_{NTC_COLD} + R_{T2})}{V_{COLD}} \quad (8)$$

R_{NTC_HOT} is the value of the NTC resistor at the high temperature of the required temperature operation range, and R_{NTC_COLD} is the value of the NTC resistor at the low temperature.

R_{T1} and R_{T2} allow the high-temperature limit and low-temperature limit to be configured independently. With this feature, the MP2731 can operate within most NTC resistor and temperature operation range requirements.

The R_{T1} and R_{T2} values depend on the type of the NTC resistor. For example, a 103AT thermistor must have the following electrical characteristics:

- At 0°C, $R_{NTC_COLD} = 27.28k\Omega$

- At 60°C, $R_{NTC_HOT} = 3.02k\Omega$

V_{HOT} is selected at 34% and V_{COLD} is selected at 72% via the REG16h register. Using Equation (7) and Equation (8), $R_{T1} = 11.8k\Omega$ and $R_{T2} = 3.06k\Omega$.

PCB Layout Guidelines

Careful PCB layout is critical to meet specified noise rejection requirements and high efficiency. For the best results, follow the guidelines below:

1. Route the power stages adjacent to their grounds. Minimize the high-side switching node (SW and inductor), the trace lengths in the high-current paths, and the current-sense resistor trace.
2. Keep the switching node short and route it away from all small control signals, especially the feedback network.
3. Place the input capacitor as close as possible to the PMID and PGND pins.
4. Place the output inductor close to the IC, and connect the output capacitor between the inductor and PGND of the IC.
5. For high-current applications, the pins for the power pads (IN, SW, SYS, BATT, and PGND) should be connected to as much copper on the board as possible. This improves thermal performance by conducting heat away from the IC.
6. Connect a ground plane directly to the return of all components through via holes. It is also recommended to put via holes inside the PGND pads for the IC, if possible. A star ground design approach is typically used to keep circuit block currents isolated (high-power/low-power small signal) which reduces noise-coupling and ground-bounce issues. A single ground plane for this design gives good results. With a small layout and a single ground plane, there is no ground-bounce issue, and having the components separated minimizes coupling between signals and stability requirements.
7. Pull the connection wire from the MCU (I²C) far from the SW mode and copper regions. SCL and SDA should be placed in close parallel.

TYPICAL APPLICATION CIRCUIT

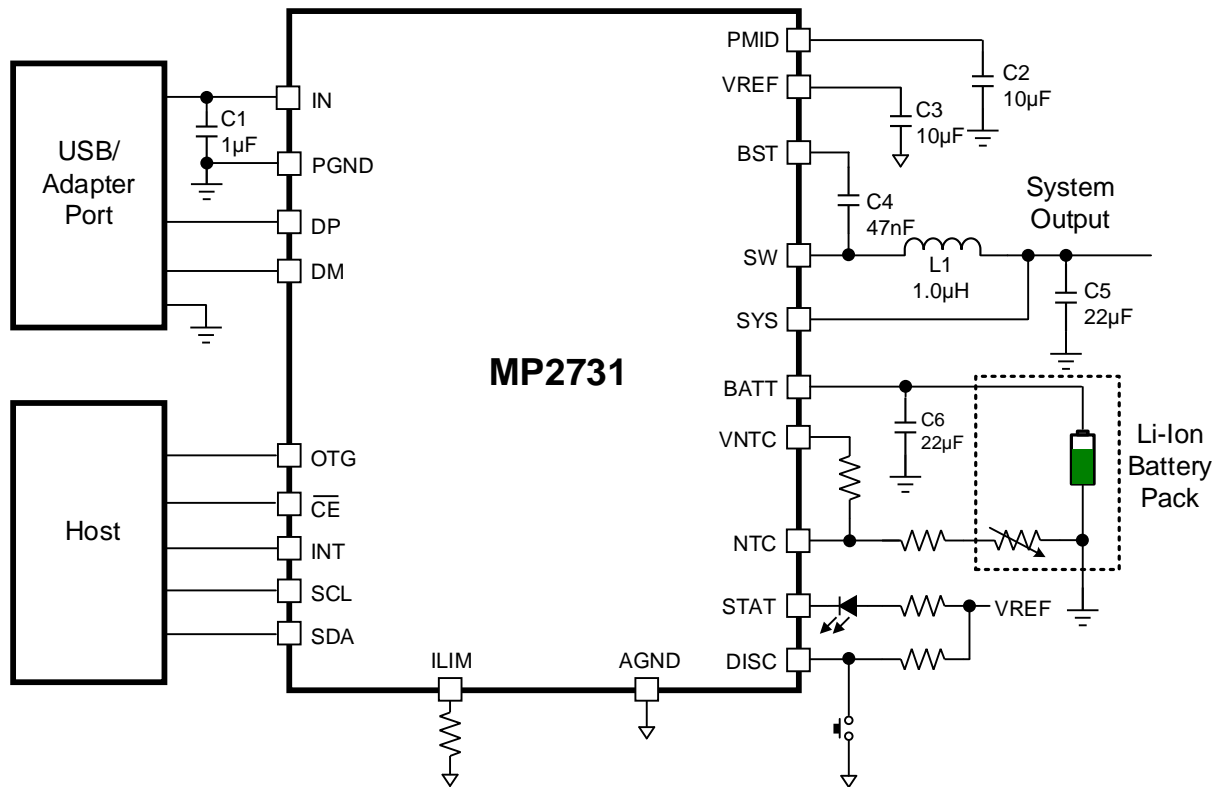

Figure 18: Typical Application Circuit

Table 3: Key BOM of Figure 18

Qty	Ref	Value	Description	Package	Manufacturer
1	C1	1µF	Ceramic capacitor, 50V, X5R or X7R	0603	Any
1	C2	10µF	Ceramic capacitor, 50V, X5R or X7R	0603	Any
1	C3	10µF	Ceramic capacitor, 16V, X5R or X7R	0603	Any
1	C4	47nF	Ceramic capacitor, 16V, X5R or X7R	0603	Any
1	C5	22µF	Ceramic capacitor, 16V, X5R or X7R	0805	Any
1	C6	22µF	Ceramic capacitor, 16V, X5R or X7R	0805	Any
1	L1	1.0µH	>9.6A	N/A	Any

PACKAGE INFORMATION

QFN-26 (3.5mmx3.5mm)

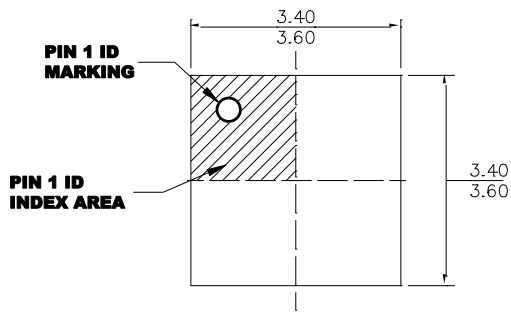

TOP VIEW

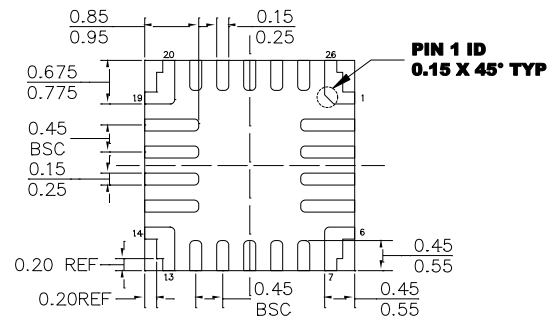

BOTTOM VIEW

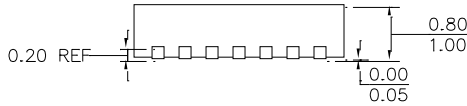

SIDE VIEW

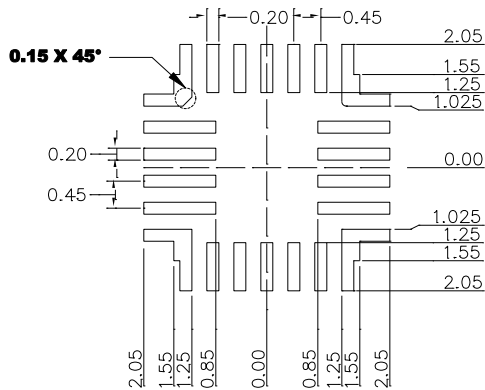

RECOMMENDED LAND PATTERN

NOTE:

- 1) ALL DIMENSIONS ARE IN MILLIMETERS.
- 2) LEAD COPLANARITY SHALL BE 0.08 MILLIMETERS MAX.
- 3) JEDEC REFERENCE IS MO-220.
- 4) DRAWING IS NOT TO SCALE.

CARRIER INFORMATION

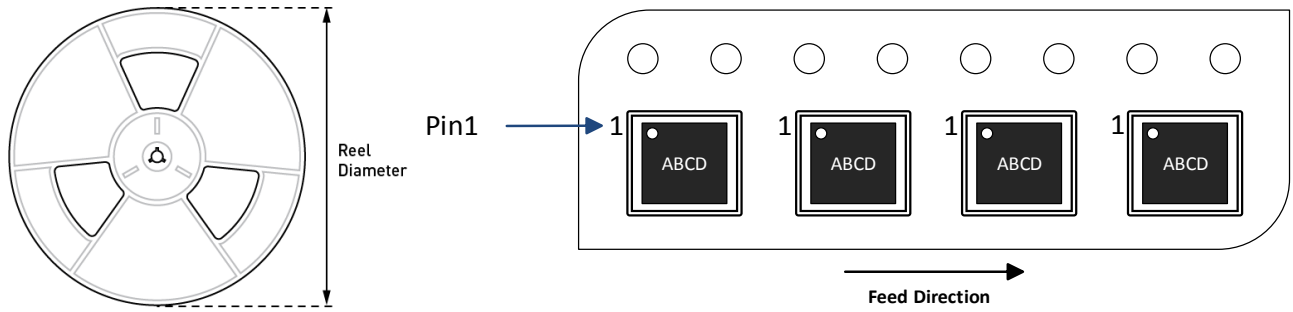

Part Number	Package Description	Quantity/ Reel	Quantity/ Tube	Quantity/ Tray	Reel Diameter	Carrier Tape Width	Carrier Tape Pitch	Trailer Leader/ Reel
MP2731GQC-xxx-Z	QFN-26 (3.5mmx3.5mm)	5000	N/A	N/A	13in	12mm	8mm	125&125

REVISION HISTORY

Revision #	Revision Date	Description	Pages Updated
1.0	5/29/2020	Initial Release	-
1.1	08/24/2020	Update safety timer expiration reset actions	Page 24
		Add function description for BG_EN bit	Page 34
		Update ADC description	Page 1, Page 26
1.2	09/22/2021	Update the factory default code to 0001	Page 3
	09/22/2021	Update the feature description	Page 1
		Update the description (3A to 4.5A)	Page 21
		Update the I ² C description	Page 27, 28, and 29

Notice: The information in this document is subject to change without notice. Please contact MPS for current specifications. Users should warrant and guarantee that third-party Intellectual Property rights are not infringed upon when integrating MPS products into any application. MPS will not assume any legal responsibility for any said applications.