

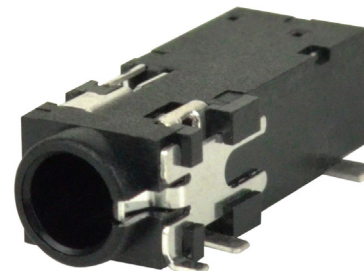

SERIES: SJ-4351X-SMT | **DESCRIPTION:** AUDIO JACK

FEATURES

- narrow footprint
- plastic bushing
- multiple switch options available



PART NUMBER KEY

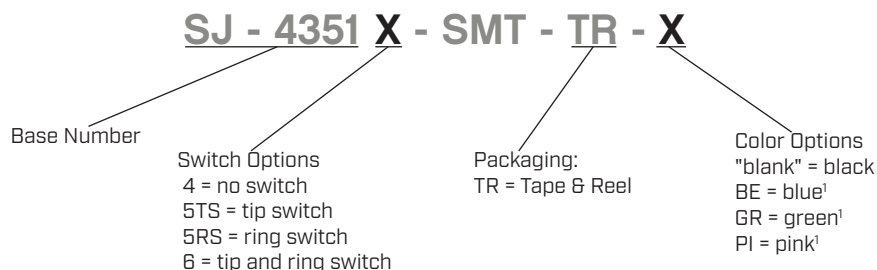

Note: ¹ tip and ring switch model only

SPECIFICATIONS

| parameter | conditions/description | min | typ | max | units |
|----------------------------|--|-----|-------|----------|----------|
| rated input voltage | | | 12 | | Vdc |
| rated input current | | | | 1 | A |
| contact resistance | between terminal and mating plug between terminal in a closed circuit | | | 50 30 | mΩ mΩ |
| insulation resistance | at 500 Vdc | 100 | | | MΩ |
| voltage withstand | for 1 minute | | | 500 | Vac |
| insertion/withdrawal force | | 0.3 | | 3 | kg |
| operating temperature | | -25 | | 85 | °C |
| life | | | 5,000 | | cycles |
| flammability rating | UL94V-0 | | | | |
| RoHS | yes | | | | |

MECHANICAL DRAWING

units: mm
 tolerance:
 X.X ±0.3 mm
 X.XX ±0.25 mm
 X.XXX ±0.20 mm
 PCB: ±0.05 mm
 unless otherwise specified

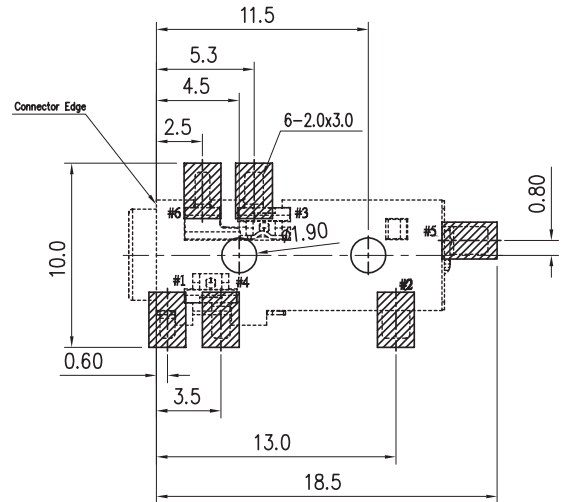
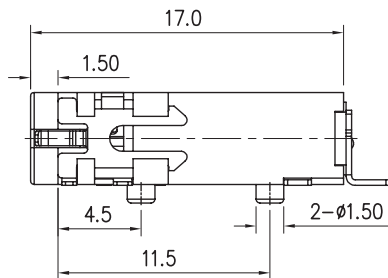
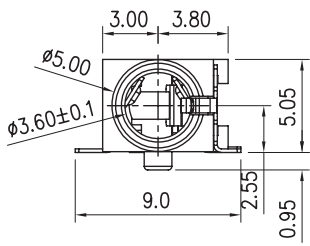
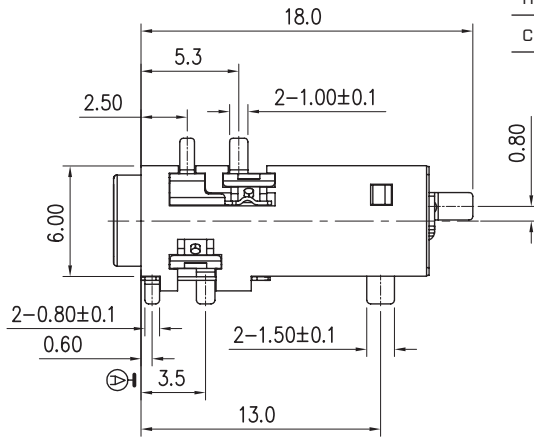
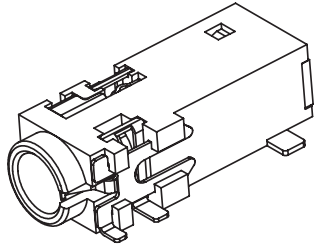

Recommended PCB Layout
Top View

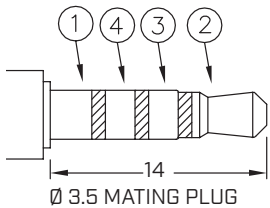

| Model No. | SJ-43514-SMT | SJ-43515TS-SMT | SJ-43515RS-SMT | SJ-43516-SMT |
|-----------|--------------|----------------|----------------|--------------|
| Schematic | | | | |
| PIN | | | | |
| 1 | sleeve | sleeve | sleeve | sleeve |
| 2 | tip | tip | tip | tip |
| 3 | ring 1 | ring 1 | ring 1 | ring 1 |
| 4 | ring 2 | ring 2 | ring 2 | ring 2 |
| 5 | NP | tip switch | NP | tip switch |
| 6 | NP | NP | ring switch | ring switch |

SOLDERABILITY

| parameter | conditions/description | min | typ | max | units |
|------------------|-------------------------|-----|-----|-----|-------|
| reel storage | 5~25°C, 20~75% humidity | | | | |
| reflow soldering | see reflow profile | 255 | 260 | | °C |

Note: 2. CUI Devices recommends usage of the product within 24 hours after T&R is opened. After 24 hours, CUI Devices recommends drying the parts prior to use.

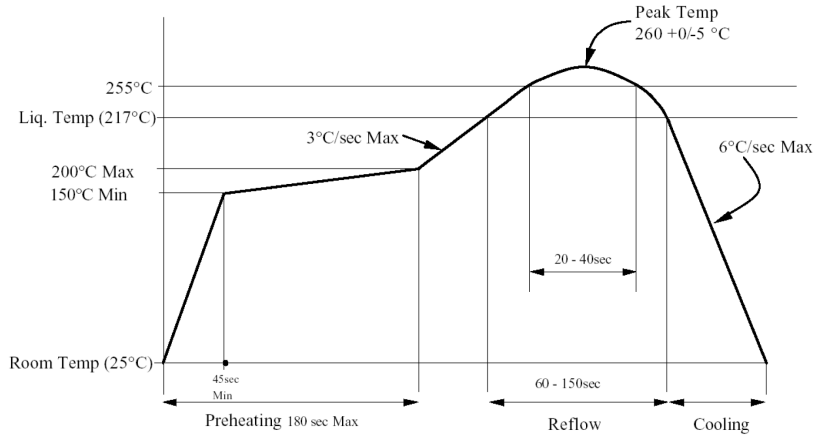

PACKAGING

units: mm

Reel Size: Ø330 mm
Reel QTY: 500 pcs per reel

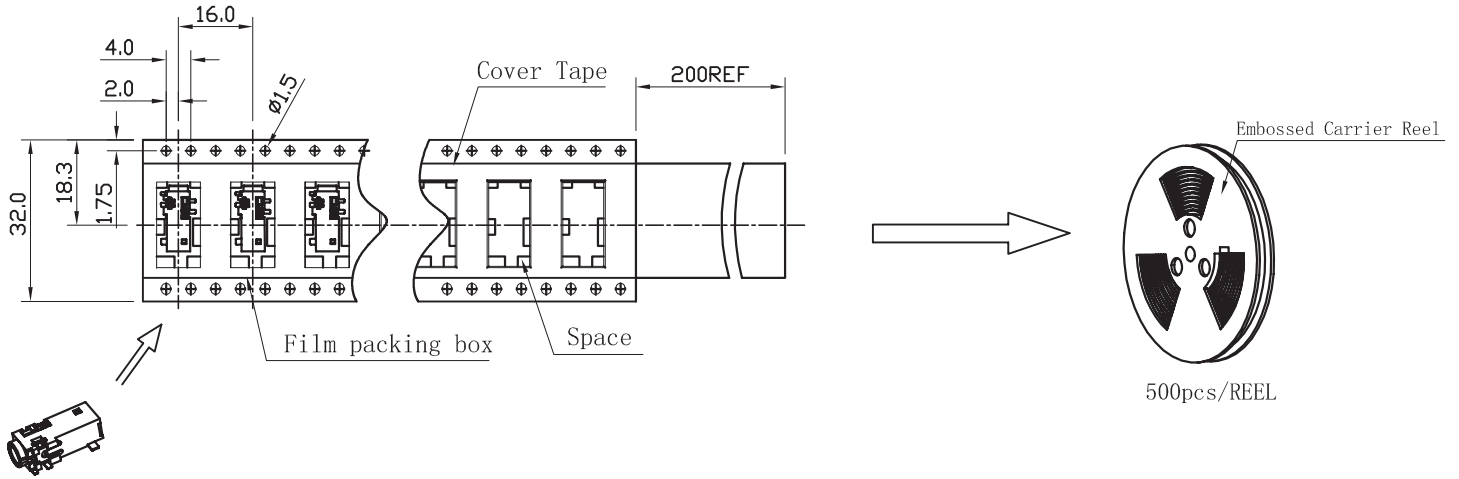

REVISION HISTORY

| rev. | description | date |
|------|---|------------|
| 1.0 | initial release | 01/17/2006 |
| 1.01 | new template applied | 02/02/2012 |
| 1.02 | added TR package and color options | 11/01/2012 |
| 1.03 | added storage and drying conditions, and tape and reel packaging details | 02/23/2018 |
| 1.04 | brand update | 10/14/2019 |
| 1.05 | product reengineered for improved manufacturability and production yield, see PCN for details | 11/17/2022 |

The revision history provided is for informational purposes only and is believed to be accurate.



CUI Devices offers a one (1) year limited warranty. Complete warranty information is listed on our website.

CUI Devices reserves the right to make changes to the product at any time without notice. Information provided by CUI Devices is believed to be accurate and reliable. However, no responsibility is assumed by CUI Devices for its use, nor for any infringements of patents or other rights of third parties which may result from its use.

CUI Devices products are not authorized or warranted for use as critical components in equipment that requires an extremely high level of reliability. A critical component is any component of a life support device or system whose failure to perform can be reasonably expected to cause the failure of the life support device or system, or to affect its safety or effectiveness.

cuiddevices.com