

GlobTek, Inc. www.globtek.com 186 Veterans Drive, Northvale, NJ 07647 Tel. (201) 784-1000 Fax (201) 784-0111	Drawing Title: GTD9X0240-24PD, DC/DC Switching Power Supply, Efficiency Level: , Case Color/Style: GlobTek Black, Vehicle/Car DC/DC Converter, DC-DC, Input Rating: 12-24 Vdc, Pigtail Leads , Output Rating: 24W, 5.0, 9.0 , 12.0V@4.8A, Output Configuration: N/A mm, N/A/ Cond, N/A, Type "C" USB "and"A" USB (USB battery charging BC1.2 compliant) Female Sockets integral to power supply enclosure, Ferrite: None, N/A, GT Cord # C54861, Pin Out: USBC A1, A12, B1, B12: COM A4, A9, B4, B9: V+ CC1:A5, D+ :A6 D- : A7 USBA Pin 1: (+), Pin 2: D-, Pin 3: D+, Pin 4: Com, Blades/Input Cord: (Order Separately), Approvals: WEEE;	
	Model No. GTD9X0240-24PD	
	Part No./Ordering No. DR6SM4800USBC-USBAPD	Rev C

In Addition to GlobTek Inc.'s renewed ISO9001:2015 - Quality Management System Certification, GlobTek Inc. is now certified to:

ISO13485:2016 - Medical Devices Quality Management System Certification

ISO14001:2015 - Environmental Management System Certification

ISO Certificates are available online at <https://www.globtek.com/iso-certificates/>

The acceptance of this specification and use of the product described in this document indicates the acceptance and binding of the customer to Globtek TERMS AND CONDITIONS (attached to the end of this document), which supersede all other agreements, terms, and conditions (<https://en.globtek.com/terms-and-conditions/>).

The purchaser of this product (Customer) agrees that it is their sole responsibility to determine suitability/fitness of the product described in this specification for their application and to take precautions for protection against any hazards attendant to the handling and use of the product.

Footnote:

GlobTek Inc. will not be liable for the safety and performance of these power supplies/battery packs if unauthorized access and repair occurs. End user should consult applicable UL, CSA or EN standards for proper installation instruction.

Limitation of Use:

GlobTek products are intended for use with commercial, medical, and/or industrial equipment only. GlobTek product are not authorized for use as mission critical components in life support hazardous environment, nuclear or aircraft applications without prior written approval from the CEO of GlobTek Inc.

Contents of this document are subject to change without prior notice.

Customer Approval of Specification:

Please approve, sign and send back to GlobTek so we can complete order processing.

A delay in receipt of this form will delay delivery schedule.

Company Name: _____	Customer P/N: _____
Quote Number: _____	Date: _____
Authorized Representative Name: _____	Authorized Representative Signature: _____

GlobTek, Inc. www.globtek.com 186 Veterans Drive, Northvale, NJ 07647 Tel. (201) 784-1000 Fax (201) 784-0111	Drawing Title: GTD9X0240-24PD, DC/DC Switching Power Supply, Efficiency Level: , Case Color/Style: GlobTek Black, Vehicle/Car DC/DC Converter, DC-DC, Input Rating: 12-24 Vdc, Pigtail Leads , Output Rating: 24W, 5.0, 9.0 , 12.0V@4.8A, Output Configuration: N/A mm, N/A/ Cond, N/A, Type "C" USB "and"A" USB (USB battery charging BC1.2 compliant) Female Sockets integral to power supply enclosure, Ferrite: None, N/A, GT Cord # C54861, Pin Out: USBC A1, A12, B1, B12: COM A4, A9, B4, B9: V+ CC1:A5, D+ :A6 D- : A7 USBA Pin 1: (+), Pin 2: D-, Pin 3: D+, Pin 4: Com, Blades/Input Cord: (Order Separately), Approvals: WEEE;	
	Model No. GTD9X0240-24PD	
	Part No./Ordering No. DR6SM4800USBC-USBAPD	Rev C

REVISION HISTORY

REV	DESCRIPTION	SUB	DATE	APPROVED
C	Update description O/P connector USBC-USBAMT: add (USB battery charging BC1.2 compliant)	QA	09/12/2022	QA
B2	Update label drawing in the deviation	QA	07/21/2021	QA
B1	Update packing: change to cellular packing and Qty to 224 pcs	QA	03/19/2021	QA
B	Update label in the deviation	QA	02/08/2021	QA
A	initial release	krakoM	12/30/2020	QA

POWER SUPPLY INFORMATION

TYPE:	Vehicle/Car DC/DC Converter
TECHNOLOGY:	DC-DC
CASE COLOR:	GlobTek Black
NAMEPLATE RATED INPUT:	12-24 Vdc, 2.5 A
INPUT CONFIG:	Pigtail Leads
WATTS:	24.0
VOLTS OUT:	5.0, 9.0 , 12.0
CURRENT OUT (Amps):	4.8
BLADE/CORD INCLUDED:	None (Order Separately)
BLADE/CORD INSTALLED:	None :(Order Separately)
INGRESS PROTECTION:	
GROUNDING CONFIGURATION:	(F1) Class II / Double Insulated
OUTPUT CONFIGURATION:	N/A mm, N/A/ Cond, N/A, Type "C" USB "and"A" USB (USB battery charging BC1.2 compliant) Female Sockets integral to power supply enclosure, Ferrite: None, N/A, GT Cord # C54861
OVERMOLDED:	No
OUTPUT CONNECTOR GENDER:	Female
CONNECTOR PIN OUT:	USBC A1, A12, B1, B12: COM A4, A9, B4, B9: V+ CC1:A5, D+ :A6 D- : A7 USBA Pin 1: (+), Pin 2: D-, Pin 3: D+, Pin 4: Com
LABEL SPECS:	Standard GT - See Deviations,L-1604
SPECIAL BARCODE LABEL	
MATERIAL:	No
PACK SPEC:	DR6SM4800USBC-USBAPD packing
USER MANUAL:	809-DESKTOPUSERMANUAL on A4 paper

PROPRIETARY INFORMATION

PROPRIETARY OF GLOBTEK, INC. ANY REPRODUCTION, DISCLOSURE OR USE OF THIS DRAWING, IN WHOLE OR IN PART, IS HEREBY PROHIBITED EXCEPT AS SPECIFIED IN

WRITING BY GLOBTEK, INC. © GlobTek, Inc. 2020 - 2022

quest /12/03/2022 1:46:49 AM CLONED FROM DR6JG4000A00G3229R6B

GlobTek, Inc. www.globtek.com 186 Veterans Drive, Northvale, NJ 07647 Tel. (201) 784-1000 Fax (201) 784-0111	Drawing Title: GTD9X0240-24PD, DC/DC Switching Power Supply, Efficiency Level: , Case Color/Style: GlobTek Black, Vehicle/Car DC/DC Converter, DC-DC, Input Rating: 12-24 Vdc, Pigtail Leads , Output Rating: 24W, 5.0, 9.0 , 12.0V@4.8A, Output Configuration: N/A mm, N/A/ Cond, N/A, Type "C" USB "and"A" USB (USB battery charging BC1.2 compliant) Female Sockets integral to power supply enclosure, Ferrite: None, N/A, GT Cord # C54861, Pin Out: USBC A1, A12, B1, B12: COM A4, A9, B4, B9: V+ CC1:A5, D+ :A6 D- : A7 USBA Pin 1: (+), Pin 2: D-, Pin 3: D+, Pin 4: Com, Blades/Input Cord: (Order Separately), Approvals: WEEE;	
	Model No. GTD9X0240-24PD	
	Part No./Ordering No. DR6SM4800USBC-USBAPD	Rev C

Notes/Modifications/Customizations (notes in this section supersede the values shown in the standard spec):
 DIMENSIONS ARE IN MM UNLESS SPECIFIED OTHERWISE.

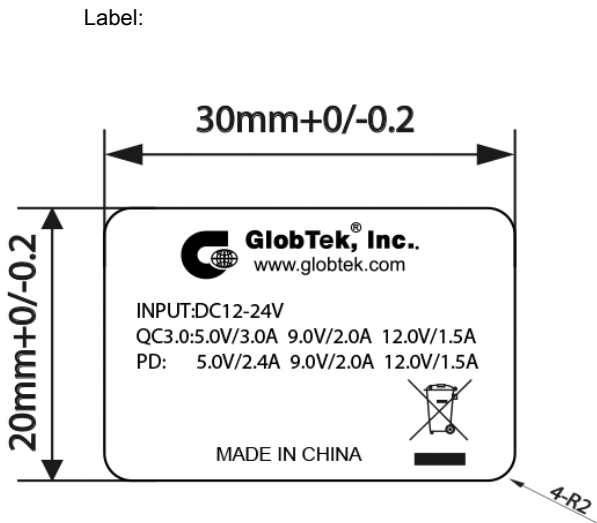

GlobTek, Inc. www.globtek.com 186 Veterans Drive, Northvale, NJ 07647 Tel. (201) 784-1000 Fax (201) 784-0111	Drawing Title: GTD9X0240-24PD, DC/DC Switching Power Supply, Efficiency Level: , Case Color/Style: GlobTek Black, Vehicle/Car DC/DC Converter, DC-DC, Input Rating: 12-24 Vdc, Pigtail Leads , Output Rating: 24W, 5.0, 9.0 , 12.0V@4.8A, Output Configuration: N/A mm, N/A/ Cond, N/A, Type "C" USB "and"A" USB (USB battery charging BC1.2 compliant) Female Sockets integral to power supply enclosure, Ferrite: None, N/A, GT Cord # C54861, Pin Out: USBC A1, A12, B1, B12: COM A4, A9, B4, B9: V+ CC1:A5, D+ :A6 D- : A7 USBA Pin 1: (+), Pin 2: D-, Pin 3: D+, Pin 4: Com, Blades/Input Cord: (Order Separately), Approvals: WEEE;	
	Model No. GTD9X0240-24PD	
	Part No./Ordering No. DR6SM4800USBC-USBAPD	Rev C

ELECTRICAL SPECIFICATIONS

Input

Input Range 12 - 24VDC

Input Current 2.5A (max) @ 12VDC & peak output current rating

Output

Output QC3.0 : 5V3A / 9V2A / 12V1.5A DC

Voltage/Current: PD: 5V2.4A / 9V2A / 12V1.5A VDC

Turn-on Delay: < 3 seconds

Output Regulation '+/- 5% MEASURED AT O/P CONNECTOR(ONLY WHEN THE INPUT VOLTAGE >13V, WHEN INPUT VOLTAGE<13V, THERE WOULD BE ABOUT 1V DROP FROM INPUT TO OUTPUT AT 12V OUTPUT)

Line Regulation: '+/- 1% TYPICAL MEASURED AT THE OUTPUT CONNECTOR(ONLY WHEN THE INPUT VOLTAGE >13V, WHEN INPUT VOLTAGE<13V, THERE WOULD BE ABOUT 1V DROP FROM INPUT TO OUTPUT AT 12V OUTPUT)

Ripple: 1% OR 100 mV WHICHEVER IS GREATER. MEASURED AT 20 MHz BANDWIDTH WITH 0.1 µf CERAMIC CAPACITOR IN PARALLEL WITH 47 µf ELECTROLYTIC CAPACITOR CONNECTED AT THE END OF OUTPUT CONNECTOR AT NOMINAL LINE

Transient Response (Step Load): 10% MAXIMUM, 1mS TYPICAL RECOVERY TIME FOR 25% STEP LOAD

INRUSH Current 15A TYPICAL AT 24V INPUT

Protections

Input Protection: Input line fusing

Output Over-Current Protection: Current limit

PROPRIETARY INFORMATION

PROPRIETARY OF GLOBTEK, INC. ANY REPRODUCTION, DISCLOSURE OR USE OF THIS DRAWING, IN WHOLE OR IN PART, IS HEREBY PROHIBITED EXCEPT AS SPECIFIED IN WRITING BY GLOBTEK, INC. © GlobTek, Inc. 2020 - 2022

GlobTek, Inc. www.globtek.com 186 Veterans Drive, Northvale, NJ 07647 Tel. (201) 784-1000 Fax (201) 784-0111	Drawing Title: GTD9X0240-24PD, DC/DC Switching Power Supply, Efficiency Level: , Case Color/Style: GlobTek Black, Vehicle/Car DC/DC Converter, DC-DC, Input Rating: 12-24 Vdc, Pigtail Leads , Output Rating: 24W, 5.0, 9.0 , 12.0V@4.8A, Output Configuration: N/A mm, N/A/ Cond, N/A, Type "C" USB "and"A" USB (USB battery charging BC1.2 compliant) Female Sockets integral to power supply enclosure, Ferrite: None, N/A, GT Cord # C54861, Pin Out: USBC A1, A12, B1, B12: COM A4, A9, B4, B9: V+ CC1:A5, D+ :A6 D- : A7 USBA Pin 1: (+), Pin 2: D-, Pin 3: D+, Pin 4: Com, Blades/Input Cord: (Order Separately), Approvals: WEEE;	
	Model No. GTD9X0240-24PD	
	Part No./Ordering No. DR6SM4800USBC-USBAPD	Rev C

Over-Temperature Protection: Thermal shutdown function

Environmental

MTBF: > 750,000 hours @ 50°C ambient (Demonstrated + Telcordia SR-332, Issue 3)
> 1,500,000 hours @ 25°C ambient (Telcordia SR-332, Issue 3)

Operating Temperature: -20°C to 45°C (nominal load)

Temperature:

Storage Temperature: -20°C to 85°C

Humidity:

0% to 95% relative humidity, non-condensing

Altitude: 5000m

Cooling: Convection

RoHS: Complies with EU 2011/65/EU and China SJ/T 11363-2006

Enclosure

Housing: High impact plastic, 94V0 polycarbonate, non-vented

Markings: Adhesive backed label or laser engraving

TO ADDRESS SYSTEM-LEVEL EMI CONCERNS, FERRITE CHOKES/BEADS MAY BE ADDED/REVISED UPON REQUEST. A SAMPLE KIT OF GLOBTEK'S STANDARD FERRITES IS AVAILABLE UNDER GLOBTEK P/N: EMI-MITIGATION-KIT1

FOR ADDITIONAL INFORMATION, PLEASE READ OUR WHITE PAPER AT:

<https://en.globtek.com/technical-articles/ferrite-kit-radiated-emi-suppression-kit-for-globtek-power-supplies-cable-assemblies>

GlobTek, Inc.
 www.globtek.com
 186 Veterans Drive,
 Northvale, NJ 07647
 Tel. (201) 784-1000
 Fax (201) 784-0111

Drawing Title: GTD9X0240-24PD, DC/DC Switching Power Supply, Efficiency Level: , Case Color/Style: GlobTek Black, Vehicle/Car DC/DC Converter, DC-DC, Input Rating: 12-24 Vdc, Pigtail Leads , Output Rating: 24W, 5.0, 9.0 , 12.0V@4.8A, Output Configuration: N/A mm, N/A/ Cond, N/A, Type "C" USB "and"A" USB (USB battery charging BC1.2 compliant) Female Sockets integral to power supply enclosure, Ferrite: None, N/A, GT Cord # C54861, Pin Out: USBC A1, A12, B1, B12: COM A4, A9, B4, B9: V+ CC1:A5, D+ :A6 D- : A7 USBA Pin 1: (+), Pin 2: D-, Pin 3: D+, Pin 4: Com, Blades/Input Cord: (Order Separately), Approvals: WEEE;

Model No. GTD9X0240-24PD

Part No./Ordering No. DR6SM4800USBC-USBAPD

Rev C

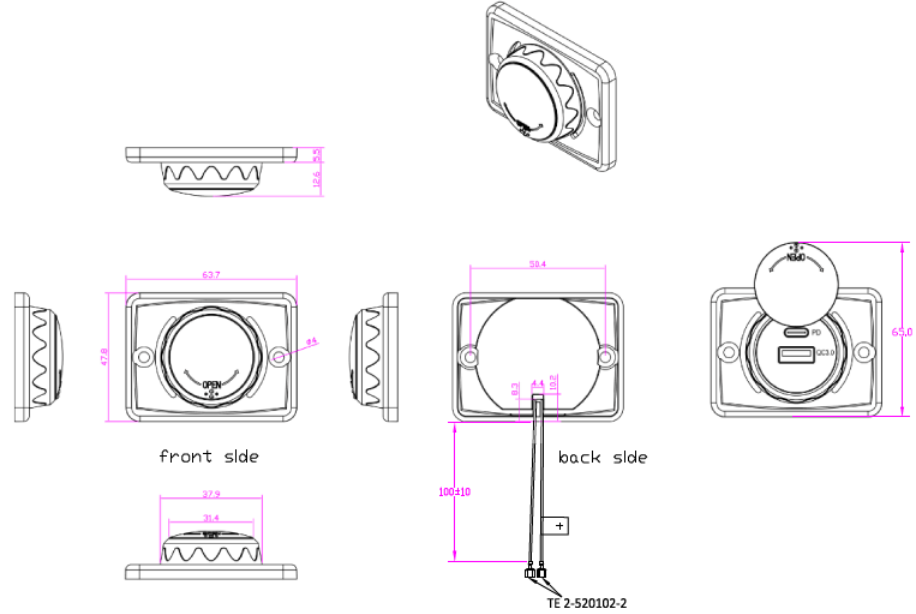

<p>GlobTek, Inc. www.globtek.com 186 Veterans Drive, Northvale, NJ 07647 Tel. (201) 784-1000 Fax (201) 784-0111</p>	<p>Drawing Title: GTD9X0240-24PD, DC/DC Switching Power Supply, Efficiency Level: , Case Color/Style: GlobTek Black, Vehicle/Car DC/DC Converter, DC-DC, Input Rating: 12-24 Vdc, Pigtail Leads , Output Rating: 24W, 5.0, 9.0 , 12.0V@4.8A, Output Configuration: N/A mm, N/A/ Cond, N/A, Type "C" USB "and"A" USB (USB battery charging BC1.2 compliant) Female Sockets integral to power supply enclosure, Ferrite: None, N/A, GT Cord # C54861, Pin Out: USBC A1, A12, B1, B12: COM A4, A9, B4, B9: V+ CC1:A5, D+ :A6 D- : A7 USBA Pin 1: (+), Pin 2: D-, Pin 3: D+, Pin 4: Com, Blades/Input Cord: (Order Separately), Approvals: WEEE;</p>
	<p>Model No. GTD9X0240-24PD</p>
	<p>Part No./Ordering No. DR6SM4800USBC-USBAPD</p>
	<p>Rev C</p>

DERATING CURVE

GlobTek, Inc. www.globtek.com 186 Veterans Drive, Northvale, NJ 07647 Tel. (201) 784-1000 Fax (201) 784-0111	Drawing Title: GTD9X0240-24PD, DC/DC Switching Power Supply, Efficiency Level: , Case Color/Style: GlobTek Black, Vehicle/Car DC/DC Converter, DC-DC, Input Rating: 12-24 Vdc, Pigtail Leads , Output Rating: 24W, 5.0, 9.0 , 12.0V@4.8A, Output Configuration: N/A mm, N/A/ Cond, N/A, Type "C" USB "and"A" USB (USB battery charging BC1.2 compliant) Female Sockets integral to power supply enclosure, Ferrite: None, N/A, GT Cord # C54861, Pin Out: USBC A1, A12, B1, B12: COM A4, A9, B4, B9: V+ CC1:A5, D+ :A6 D- : A7 USBA Pin 1: (+), Pin 2: D-, Pin 3: D+, Pin 4: Com, Blades/Input Cord: (Order Separately), Approvals: WEEE;	
	Model No. GTD9X0240-24PD	
	Part No./Ordering No. DR6SM4800USBC-USBAPD	Rev C

INPUT CONFIGURATION

(F1) Class II / Double Insulated

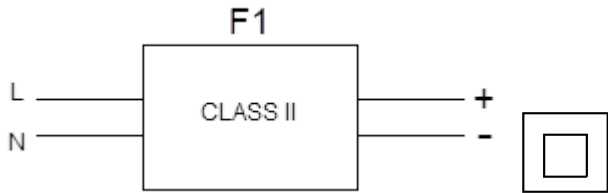

[Alternate grounding configurations](#) available upon request.

Blades/Cord Included:None:(Order Separately)

Blades/Cord Installed:None:(Order Separately)

Lead Wire, Terminal :TE 2-520102-2

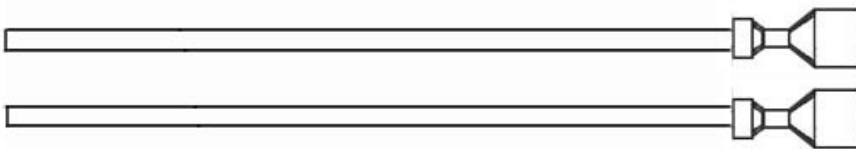

GlobTek, Inc. www.globtek.com 186 Veterans Drive, Northvale, NJ 07647 Tel. (201) 784-1000 Fax (201) 784-0111	Drawing Title: GTD9X0240-24PD, DC/DC Switching Power Supply, Efficiency Level: , Case Color/Style: GlobTek Black, Vehicle/Car DC/DC Converter, DC-DC, Input Rating: 12-24 Vdc, Pigtail Leads , Output Rating: 24W, 5.0, 9.0 , 12.0V@4.8A, Output Configuration: N/A mm, N/A/ Cond, N/A, Type "C" USB "and"A" USB (USB battery charging BC1.2 compliant) Female Sockets integral to power supply enclosure, Ferrite: None, N/A, GT Cord # C54861, Pin Out: USBC A1, A12, B1, B12: COM A4, A9, B4, B9: V+ CC1:A5, D+ :A6 D- : A7 USBA Pin 1: (+), Pin 2: D-, Pin 3: D+, Pin 4: Com, Blades/Input Cord: (Order Separately), Approvals: WEEE;	
	Model No. GTD9X0240-24PD	
	Part No./Ordering No. DR6SM4800USBC-USBAPD	Rev C

OUTPUT CORD AND CONNECTOR:		USBC-USBAMT/C54861
ACTUAL CONNECTORS, OVERMOLDS, FERRITES MAY VARY SLIGHTLY FROM THE PICTURE BELOW		
CABLE TYPE	N/A	
CABLE LENGTH (mm)	N/A	
CABLE TOLERANCE (mm)	N/A	
WIRE GAUGE (AWG)	N/A	
CONDUCTORS		
HANK DIMENSION (mm)	N/A	
CABLE / CONNECTOR OVERMOLD COLOR	N/A	
FERRITE TYPE / DIMENSION	None	
FERRITE # OF TURNS (Definition)	N/A	
FERRITE DIMENSION FROM STRAIN RELIEF	N/A	
FERRITE DIMENSION FROM PLUG	N/A	
PLUG TYPE	Type "C" USB "and"A" USB (USB battery charging BC1.2 compliant) Female Sockets integral to power supply enclosure	
OUTPUT CONNECTOR GENDER	Female	
OVERMOLDED	No	
OVER MOLD ORIENTATION	PCB Mount Connector	
CONNECTOR PIN OUT:	USBC A1, A12, B1, B12: COM A4, A9, B4, B9: V+ CC1:A5, D+ :A6 D- : A7 USBA Pin 1: (+), Pin 2: D-, Pin 3: D+, Pin 4: Com	
ADDITIONAL REQUIREMENTS		
ADDITIONAL OUTPUT PLUG OPTIONS ARE AVAILABLE AT https://www.globtek.com/connectors/ STANDARD PLUGS AND CONNECTORS CAN BE SEEN ONLINE AT https://www.globtek.com/connectors/ CALCULATE VOLTAGE REGULATION/DROP WITH OUR ONLINE CALCULATOR: https://en.globtek.com/output-cable-regulation-calculator/		

GlobTek, Inc. www.globtek.com 186 Veterans Drive, Northvale, NJ 07647 Tel. (201) 784-1000 Fax (201) 784-0111	Drawing Title: GTD9X0240-24PD, DC/DC Switching Power Supply, Efficiency Level: , Case Color/Style: GlobTek Black, Vehicle/Car DC/DC Converter, DC-DC, Input Rating: 12-24 Vdc, Pigtail Leads , Output Rating: 24W, 5.0, 9.0 , 12.0V@4.8A, Output Configuration: N/A mm, N/A/ Cond, N/A, Type "C" USB "and"A" USB (USB battery charging BC1.2 compliant) Female Sockets integral to power supply enclosure, Ferrite: None, N/A, GT Cord # C54861, Pin Out: USBC A1, A12, B1, B12: COM A4, A9, B4, B9: V+ CC1:A5, D+ :A6 D- : A7 USBA Pin 1: (+), Pin 2: D-, Pin 3: D+, Pin 4: Com, Blades/Input Cord: (Order Separately), Approvals: WEEE;	
	Model No. GTD9X0240-24PD	
	Part No./Ordering No. DR6SM4800USBC-USBAPD	Rev C

OUTPUT CONNECTOR HOOK UP

TO ADDRESS SYSTEM-LEVEL EMI CONCERNS, FERRITE CHOKES/BEADS MAY BE ADDED/REVISED UPON REQUEST. A SAMPLE KIT OF GLOBTEK'S STANDARD FERRITES IS AVAILABLE UNDER GLOBTEK P/N: EMI-MITIGATION-KIT1

FOR ADDITIONAL INFORMATION, PLEASE READ OUR WHITE PAPER AT:

<https://en.globtek.com/technical-articles/ferrite-kit-radiated-emi-suppression-kit-for-globtek-power-supplies-cable-assemblies>

GlobTek, Inc. www.globtek.com 186 Veterans Drive, Northvale, NJ 07647 Tel. (201) 784-1000 Fax (201) 784-0111	Drawing Title: GTD9X0240-24PD, DC/DC Switching Power Supply, Efficiency Level: , Case Color/Style: GlobTek Black, Vehicle/Car DC/DC Converter, DC-DC, Input Rating: 12-24 Vdc, Pigtail Leads , Output Rating: 24W, 5.0, 9.0 , 12.0V@4.8A, Output Configuration: N/A mm, N/A/ Cond, N/A, Type "C" USB "and"A" USB (USB battery charging BC1.2 compliant) Female Sockets integral to power supply enclosure, Ferrite: None, N/A, GT Cord # C54861, Pin Out: USBC A1, A12, B1, B12: COM A4, A9, B4, B9: V+ CC1:A5, D+ :A6 D- : A7 USBA Pin 1: (+), Pin 2: D-, Pin 3: D+, Pin 4: Com, Blades/Input Cord: (Order Separately), Approvals: WEEE;	
	Model No. GTD9X0240-24PD	Part No./Ordering No. DR6SM4800USBC-USBAPD
		Rev C

LABEL:L-1604

LABEL P/N:	Standard GT - See Deviations
MATERIAL:	Flat Thermal Transfer, Imprintable, Polyester Label and/or Pad Printed and/or Molded, and/or Laser Engraved in the case
BACKGROUND COLOR:	Black if housing is Black, White or Silver if housing is White or Gray.
TEXT COLOR:	White or Silver if label is Black Background for Black housing. Black if label is White or Silver background and Housing is White or Gray.
LABEL WIDTH (mm):	110.00
LABEL HEIGHT (mm):	50.00
SPECIAL BARCODE LABEL MATERIAL:	No

Below is the minimum information which will appear on the label. NOTE: in the logo area additional/actual positioning of symbols and text is subjected to change as per agency updates/requirements or additional model approvals become available. Regulatory certifications/label markings may be in logo area on the label or molded into the case housing outside the label area. Information will be shown via label and/or pad printed and/or molded and/or laser engraved in the case. * Date code markings at GlobTek option.



Please refer to the deviations section of the product specifications for additional details regarding the label.



or

DATE CODE B *:

WWYY
 WW = WEEK
 YY = YEAR

- A=DC/DC Switching Power Supply
- B=P/N: (料号) DR6SM4800USBC-USBAPD
- C=Model (型号) GTD9X0240-24PD
- D=Input (输入)12-24 Vdc, 2.5 A
- E=Output (输出)5.0, 9.0 , 12.0 V **==** 4.8 A, 24.0W

GlobTek, Inc. www.globtek.com 186 Veterans Drive, Northvale, NJ 07647 Tel. (201) 784-1000 Fax (201) 784-0111	Drawing Title: GTD9X0240-24PD, DC/DC Switching Power Supply, Efficiency Level: , Case Color/Style: GlobTek Black, Vehicle/Car DC/DC Converter, DC-DC, Input Rating: 12-24 Vdc, Pigtail Leads , Output Rating: 24W, 5.0, 9.0 , 12.0V@4.8A, Output Configuration: N/A mm, N/A/ Cond, N/A, Type "C" USB "and"A" USB (USB battery charging BC1.2 compliant) Female Sockets integral to power supply enclosure, Ferrite: None, N/A, GT Cord # C54861, Pin Out: USBC A1, A12, B1, B12: COM A4, A9, B4, B9: V+ CC1:A5, D+ :A6 D- : A7 USBA Pin 1: (+), Pin 2: D-, Pin 3: D+, Pin 4: Com, Blades/Input Cord: (Order Separately), Approvals: WEEE;	
	Model No. GTD9X0240-24PD	
	Part No./Ordering No. DR6SM4800USBC-USBAPD	Rev C

AGENCY ONLINE DOCUMENTS	http://www.globtek.info/certs/GTD9X0240/
CE EC-Declaration for Medical	Contact GlobTek for more information
CE EC-Declaration for Industrial/Commercial/ITE	Contact GlobTek for more information
CE EC-Declaration for Household	Contact GlobTek for more information
UKCA-Declaration for Medical	Contact GlobTek for more information
UKCA-Declaration for Industrial/Commercial/ITE	Contact GlobTek for more information
UKCA-Declaration for Household	Contact GlobTek for more information
Morocco SDoC Declaration	https://globtek.secure.force.com/models/Morocco_SDoC_Declaration?id=a003a00000MYTBTEA5
RoHS/RoHS3 Declaration	https://www.globtek.com/pdf/rohs_cert/01t3a000005CyrAAC
REACH Declaration	https://www.globtek.com/pdf/iso_certificates/REACH.pdf
Conflict Minerals Declaration	https://www.globtek.com/pdf/conflict-minerals.pdf
Prop 65 Statement	https://en.globtek.com/prop-65-statement.pdf

IPXY rating is based on 3rd party testing and customers should check suitability and test system level IPXY rating before ordering.

Regulatory Certifications/Label Markings

Below follows a link to the latest regulatory certifications and marks for this specific product. National standards as well as certification schemes are constantly changing and so is the set of certification marks and symbols applicable to this product. Various standards, marks and symbols, and certificates are subject to change at any time without notice.

Additional standards or unique country certifications are available upon request. Please contact Globtek to request a quotation.

LATEST PRODUCT/MODEL CERTIFICATIONS: <https://www.globtek.com/datasheet/w70631>

AGENCY ONLINE DOCUMENTS: <http://www.globtek.info/certs/GTD9X0240/>



(F1) Class II / Double Insulated

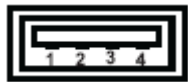
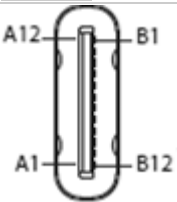

USBC
 A1, A12, B1, B12: COM
 A4, A9, B4, B9: V+
 CC1:A5,
 D+ :A6
 D- : A7
 USBA
 Pin 1: (+), Pin 2: D-, Pin 3: D+, Pin 4:
 Com

[Mates with GlobTek USB Type C cables available at: https://en.globtek.com/cordsets/usb-cables-cords-assemblies](#)

GlobTek, Inc. www.globtek.com 186 Veterans Drive, Northvale, NJ 07647 Tel. (201) 784-1000 Fax (201) 784-0111	Drawing Title: GTD9X0240-24PD, DC/DC Switching Power Supply, Efficiency Level: , Case Color/Style: GlobTek Black, Vehicle/Car DC/DC Converter, DC-DC, Input Rating: 12-24 Vdc, Pigtail Leads , Output Rating: 24W, 5.0, 9.0 , 12.0V@4.8A, Output Configuration: N/A mm, N/A/ Cond, N/A, Type "C" USB "and"A" USB (USB battery charging BC1.2 compliant) Female Sockets integral to power supply enclosure, Ferrite: None, N/A, GT Cord # C54861, Pin Out: USBC A1, A12, B1, B12: COM A4, A9, B4, B9: V+ CC1:A5, D+ :A6 D- : A7 USBA Pin 1: (+), Pin 2: D-, Pin 3: D+, Pin 4: Com, Blades/Input Cord: (Order Separately), Approvals: WEEE;	
	Model No. GTD9X0240-24PD	
	Part No./Ordering No. DR6SM4800USBC-USBAPD	Rev C

PACKAGING

Packing Spec P/N:	DR6SM4800USBC-USBAPD packing
Box Qty:	224
Gift Box Size (mm):	Cellular packing
Gift Box Color:	White
Master Carton Size (mm):	415 x 465 x 225
Master Carton Cubic Volume (m³):	0.04
Master GW (Kg):	15.0 kg
BLADES INCLUDED:	None: (Order Separately)
BLADE/CORD INSTALLED:	None: (Order Separately)
USER MANUAL*:	809-DESKTOPUSERMANUAL on A4 paper
USER MANUAL WEB LINK:	https://en.globtek.com/pdf/809-DESKTOPUSERMANUAL.jpg

* This specification sheet is considered the user manual for all applications. It is expected that the buyer of this product will use it to formulate their own user manual for their end product and a user manual specifically for the power adapter is not usually required. If a user manual is not specifically listed above then none will be provided with this unit.

If specific packaging is required, this section must specify all requirements and note "no exceptions". If this section does not specify packaging, it is subject to change without notice at GlobTek's discretion

GlobTek, Inc.
 www.globtek.com
 186 Veterans Drive,
 Northvale, NJ 07647
 Tel. (201) 784-1000
 Fax (201) 784-0111

Drawing Title: GTD9X0240-24PD, DC/DC Switching Power Supply, Efficiency Level: , Case Color/Style: GlobTek Black, Vehicle/Car DC/DC Converter, DC-DC, Input Rating: 12-24 Vdc, Pigtail Leads , Output Rating: 24W, 5.0, 9.0 , 12.0V@4.8A, Output Configuration: N/A mm, N/A/ Cond, N/A, Type "C" USB "and"A" USB (USB battery charging BC1.2 compliant) Female Sockets integral to power supply enclosure, Ferrite: None, N/A, GT Cord # C54861, Pin Out: USBC A1, A12, B1, B12: COM A4, A9, B4, B9: V+ CC1:A5, D+ :A6 D- : A7 USBA Pin 1: (+), Pin 2: D-, Pin 3: D+, Pin 4: Com, Blades/Input Cord: (Order Separately), Approvals: WEEE;

Model No. GTD9X0240-24PD

Part No./Ordering No. DR6SM4800USBC-USBAPD

Rev C

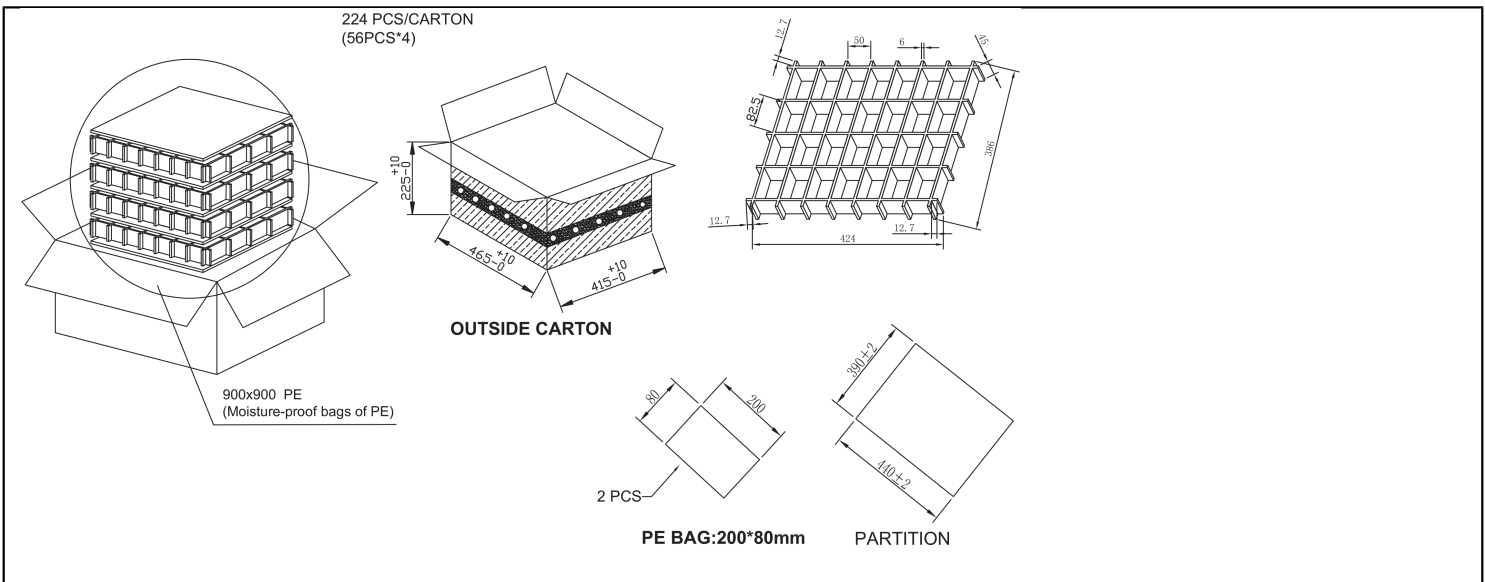

GlobTek, Inc. www.globtek.com 186 Veterans Drive, Northvale, NJ 07647 Tel. (201) 784-1000 Fax (201) 784-0111	Drawing Title: GTD9X0240-24PD, DC/DC Switching Power Supply, Efficiency Level: , Case Color/Style: GlobTek Black, Vehicle/Car DC/DC Converter, DC-DC, Input Rating: 12-24 Vdc, Pigtail Leads , Output Rating: 24W, 5.0, 9.0 , 12.0V@4.8A, Output Configuration: N/A mm, N/A/ Cond, N/A, Type "C" USB "and"A" USB (USB battery charging BC1.2 compliant) Female Sockets integral to power supply enclosure, Ferrite: None, N/A, GT Cord # C54861, Pin Out: USBC A1, A12, B1, B12: COM A4, A9, B4, B9: V+ CC1:A5, D+ :A6 D- : A7 USBA Pin 1: (+), Pin 2: D-, Pin 3: D+, Pin 4: Com, Blades/Input Cord: (Order Separately), Approvals: WEEE;	
	Model No. GTD9X0240-24PD	
	Part No./Ordering No. DR6SM4800USBC-USBAPD	Rev C

INSTRUCTIONS TO THE OEM SYSTEMS ENGINEER

It is the responsibility of the OEM systems engineer to provide the end system user instructions and warnings for the use of this product in the end system.

If an input cord is required for this product, AC Mains voltage should be provided to the power supply by a power supply cord approved to the national standards of the country in which it will be used.

This product is not designed to be repaired. No serviceable parts inside. A blown internal fuse is an indication of catastrophic failure of circuit component(s). If a Failure Analysis is required for a failed power supply/battery charger, please return the damaged unit to GlobTek for an accurate determination of the root cause of the failure.

EMC Compliance of the complete OEM product, including the GlobTek power supply/battery charger needs to be verified by the OEM systems engineer.

INSTRUCTION SHEET