



DESCRIPTION

The MPQ4572 is a fully integrated, fixed-frequency, synchronous step-down converter. It can achieve up to 2A of continuous output current with peak current control for excellent transient response.

The wide 4.5V to 60V input voltage range accommodates a variety of step-down applications in an automotive input environment. The device's 2 μ A shutdown mode quiescent current makes it ideal for battery-powered applications.

The MPQ4572 integrates internal high-side and low-side power MOSFETs for high efficiency without an external Schottky diode. It employs advanced asynchronous modulation (AAM) to achieve high efficiency during light-load conditions by scaling down the frequency to reduce switching and gate driver losses.

Standard features include built-in soft start, enable control, and power good indication. High-duty cycle and low-dropout mode are provided for automotive cold crank conditions.

The chip provides over-current protection (OCP) with valley-current detection to avoid current runaway. It also has hiccup short-circuit protection (SCP), input under-voltage lockout (UVLO), and auto-recovery thermal protection.

With internal compensation, the MPQ4572 can offer a very compact solution with a minimal number of readily available, standard external components. It is available in a QFN-12 (2.5mmx3mm) package.

FEATURES

- Wide 4.5V to 60V Operating Input Range
- 2A Continuous Output Current
- High-Efficiency, Synchronous Mode Control
- 250m Ω /45m Ω Internal Power MOSFETs
- Configurable Frequency Up to 2.2MHz
- 180° Out-of-Phase SYNC Out Clock
- 40 μ A Quiescent Current
- Low Shutdown Mode Current: 2 μ A
- FB-Tolerance: 1% at Room Temp, 2% at Full Temp
- Selectable AAM or Forced CCM Operation during Light-Load Conditions
- Internal 0.45ms Soft Start
- Remote EN Control
- Power Good Indicator
- Low-Dropout Mode
- Over-Current Protection (OCP)
- Short-Circuit Protection with Hiccup Mode
- V_{IN} Under-Voltage Lockout (UVLO)
- Thermal Shutdown
- Available in a QFN-12 (2.5mmx3mm) Package
- Available in a Wettable Flank Package
- Available in AEC-Q100 Grade-1

APPLICATIONS

- Automotive Infotainment
- Automotive Lamps and LEDs
- Automotive Motor Control
- Industrial Power Systems

All MPS parts are lead-free, halogen-free, and adhere to the RoHS directive. For MPS green status, please visit the MPS website under Quality Assurance. "MPS", the MPS logo, and "Simple, Easy Solutions" are trademarks of Monolithic Power Systems, Inc. or its subsidiaries.

TYPICAL APPLICATION

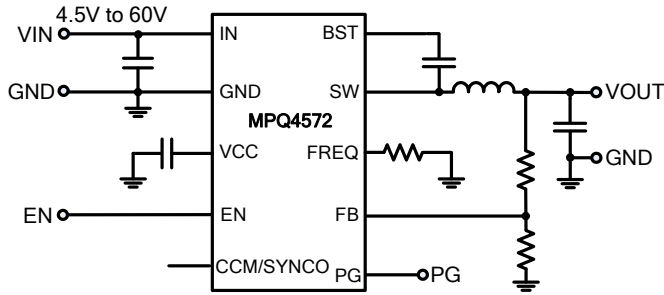

Efficiency vs. Load Current

$V_{OUT} = 5V$, $L = 15\mu H$, $f_{sw} = 400kHz$, AAM

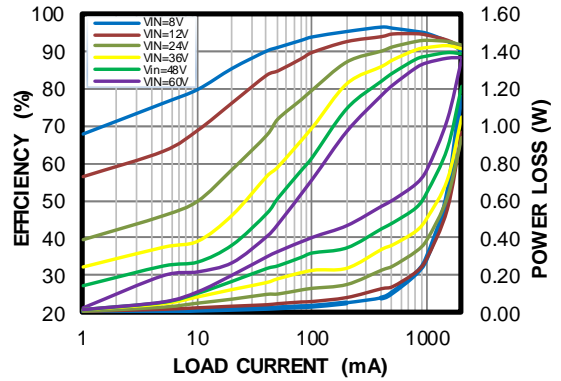

ORDERING INFORMATION

Part Number*	Package	Top Marking	MSL Rating**
MPQ4572GQB	QFN-12 (2.5mmx3mm)	See Below	1
MPQ4572GQB-AEC1			
MPQ4572GQBE-AEC1***			

* For Tape & Reel, add suffix -Z (e.g. MPQ4572GQB-Z).

** Moisture Sensitivity Level Rating.

*** Wettable flank.

TOP MARKING (MPQ4572GQB AND MPQ4572GQB-AEC1)

—
AVN
YWW
LLL

AVN: Product code of MPQ4572GQB and MPQ4572GQB-AEC1

Y: Year code

WW: Week code

LLL: Lot number

TOP MARKING (MPQ4572GQBE-AEC1)

—
BMM
YWW
LLL

BMM: Product code of MPQ4572GQBE-AEC1

Y: Year code

WW: Week code

LLL: Lot number

PACKAGE REFERENCE

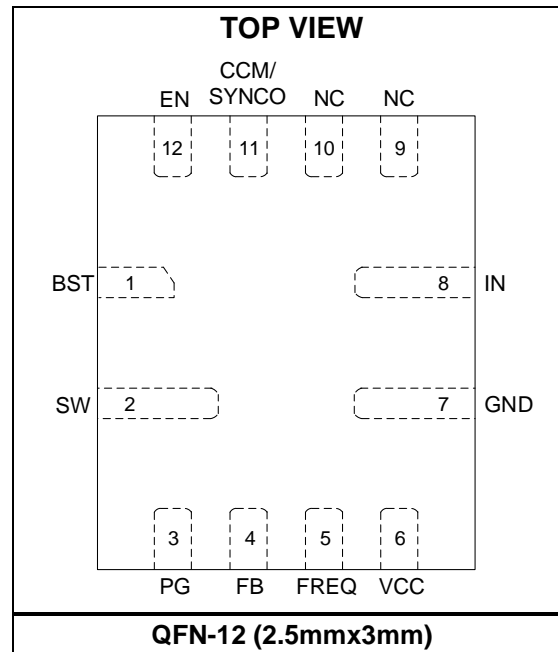

PIN FUNCTIONS

Pin #	Name	Description
1	BST	Bootstrap. Connect a capacitor between SW and BST to form a floating supply across the high-side switch driver.
2	SW	Switch output. SW is the output of the internal power switches. A wide PCB trace is recommended.
3	PG	Power good indicator. The pin is an open drain; it requires a pull-up resistor to the power source. PG is pulled up to the power source if the output voltage is within 90% to 108% of the nominal voltage. It goes low when the output voltage exceeds 116% or falls below 84% of the nominal voltage.
4	FB	Feedback point. FB is the negative input of the error amplifier. Connect FB to the tap of an external resistor divider between the output and GND to set the regulation voltage. In addition, power good and under-voltage lockout circuits use FB to monitor the output voltage.
5	FREQ	Configurable switching frequency. Connect a resistor to GND to set the switching frequency.
6	VCC	Internal bias supply. This pin supplies power to the internal control circuit and gate drivers. A decoupling capacitor (greater than 1 μ F) to ground is required close to this pin.
7	GND	IC ground. Connect the pin to larger copper areas to the negative terminals of the input and output capacitors.
8	IN	Input supply. This pin supplies all power to the converter. Place a decoupling capacitor to ground, as close as possible to the IC, to reduce switching spikes.
9, 10	NC	No connection. These pins can be connected to GND to get better thermal and EMI performance in PCB layout.
11	CCM/ SYNCO	Mode selection/synchronization output. Connect the CCM pin to GND through a resistor (10k Ω to 300k Ω) to force the converter into CCM. Float this pin to force the converter into non-synchronous AAM mode under light-load conditions. CCM/SYNCO is also a synchronization output pin that can output a 180° out-of-phase clock to other devices.
12	EN	Enable. Drive EN high to turn on the device; float or drive it low to turn off the device.

ABSOLUTE MAXIMUM RATINGS ⁽¹⁾

V_{IN}	65V
V_{SW}	-0.3V to $V_{IN} + 0.3V$
V_{BST}	$V_{SW} + 6V$
All other pins	-0.3V to +6V
Continuous power dissipation ($T_A = 25^\circ C$) ⁽²⁾	
QFN-12 (2.5mmx3mm)	2.08W
Junction temperature	150°C
Lead temperature	260°C
Storage temperature	-65°C to +150°C

Electrostatic Discharge (ESD) Rating

HBM (Human body model)	±2kV
CDM (Charged device model)	±750V

Recommended Operating Conditions

Continuous supply voltage (V_{IN})	4.5V to 60V
Output voltage (V_{OUT})	1V to 90% of V_{IN}
Load current range	0A to 2A
Operating junction temp (T_J)	-40°C to +150°C

Thermal Resistance	θ_{JA}	θ_{JC}
QFN-12 (2.5mmx3mm)		
JESD51-7 ⁽³⁾	60.....	13....°C/W
EVQ4572-QB-00A ⁽⁴⁾	45.....	11....°C/W

Notes:

- 1) Absolute maximum ratings are rated under room temperature, unless otherwise noted. Exceeding these ratings may damage the device.
- 2) The maximum allowable power dissipation is a function of the maximum junction temperature T_J (MAX), the junction-to-ambient thermal resistance θ_{JA} , and the ambient temperature T_A . The maximum allowable continuous power dissipation at any ambient temperature is calculated by P_D (MAX) = $(T_J$ (MAX) - T_A) / θ_{JA} . Exceeding the maximum allowable power dissipation will cause excessive die temperature, and the module will go into thermal shutdown. Internal thermal shutdown circuitry protects the device from permanent damage.
- 3) Measured on JESD51-7, 4-layer PCB.
- 4) Measured on MPS standard EVB: 8.9cmx8.9cm, 2oz copper thick, 4-layer PCB.

ELECTRICAL CHARACTERISTICS

$V_{IN} = 24V$, $V_{EN} = 2V$, $T_J = -40^{\circ}C$ to $+125^{\circ}C$, typical values are at $T_J = 25^{\circ}C$, unless otherwise noted.

Parameters	Symbol	Condition	Min	Typ	Max	Units
Input Supply and Under-Voltage Lockout (UVLO)						
Supply current (quiescent)	I_Q	No load, $V_{FB} = 0.85V$, AAM		40	65	μA
Supply current (shutdown)	I_{SD}	$V_{EN} = 0V$		2	5	μA
V_{IN} UVLO rising threshold	$INUV_{Vth-R}$		3.8	4.0	4.2	V
V_{IN} UVLO falling threshold	$INUV_{Vth-F}$		3.3	3.5	3.7	V
V_{IN} UVLO hysteresis threshold	$INUV_{HYS}$			500		mV
Output and Regulation						
Regulated FB reference	V_{REF}	$T_J = 25^{\circ}C$	0.792	0.800	0.808	V
		$T_J = -40^{\circ}C$ to $+125^{\circ}C$	0.784		0.816	V
FB input current	I_{FB}	$V_{FB} = 0.85V$		10	50	nA
Switches and Frequency						
High-side switch on resistance	R_{DSON-H}	$V_{BST} - V_{SW} = 5V$, $T_J = +25^{\circ}C$	150	250	350	m Ω
		$V_{BST} - V_{SW} = 5V$, $T_J = -40^{\circ}C$ to $+125^{\circ}C$	100		500	
Low-side switch on resistance	R_{DSON-L}	$T_J = 25^{\circ}C$	30	45	60	m Ω
		$T_J = -40^{\circ}C$ to $+125^{\circ}C$	20		90	
SW leakage current	I_{SW-LKG}	$V_{EN} = 0V$, $V_{SW} = 0V$ or $60V$		0.1	30	μA
Switching frequency	f_{SW}	$R_{FREQ} = 76.8k\Omega$	300	400	500	kHz
		$R_{FREQ} = 28k\Omega$	750	1000	1250	kHz
		$R_{FREQ} = 12.1k\Omega$	1800	2200	2700	kHz
Minimum on time ⁽⁵⁾	t_{ON-MIN}			90		ns
Minimum off time ⁽⁵⁾	$t_{OFF-MIN}$			100		ns
Power Good (PG)						
PG current sink capacity	$V_{PG-SINK}$	Sink 4mA			300	mV
PG delay time	$t_{PG-DELAY}$	Rising edge		70		μs
		Falling edge		25		μs
PG leakage current	I_{PG-LKG}			10	1000	nA
PG rising threshold (V_{FB} / V_{REF})	PG_{RISING}	V_{FB} rising		90		%
		V_{FB} falling		108		%
PG falling threshold (V_{FB} / V_{REF})	$PG_{FALLING}$	V_{FB} falling		84		%
		V_{FB} rising		116		%
Enable (EN)						
EN input rising threshold	$V_{EN-RISING}$		1.38	1.45	1.52	V
EN input falling threshold	$V_{EN-FALLING}$		1.05	1.12	1.19	V
EN threshold hysteresis	V_{EN-HYS}			330		mV
EN input current	I_{EN}	$V_{EN} = 2V$		0.7		μA
EN turn-off delay	$t_{EN-DELAY}$		5			μs
BST						
BST-SW UVLO				1.4	2.5	V
BST-SW UVLO hysteresis				60		mV
Soft Start and VCC						
Soft-start time	t_{SS}			0.45		ms
VCC regulator	V_{CC}	$I_{CC} = 0mA$	4.6	4.9	5.2	V

ELECTRICAL CHARACTERISTICS (continued)
 $V_{IN} = 24V$, $V_{EN} = 2V$, $T_J = -40^{\circ}C$ to $+125^{\circ}C$, typical values are at $T_J = 25^{\circ}C$, unless otherwise noted.

Parameters	Symbol	Condition	Min	Typ	Max	Units
Protections						
Peak current limit	I _{PEAK-LIMIT}	20% duty cycle	2.4	3.5	4.6	A
Valley current limit	I _{VALLEY-LIMIT}		2.4			A
Zero-cross threshold	I _{ZCD}	AAM	-100	140	+300	mA
Negative current limit	I _{NEG-LIMIT}	FCCM	-2	-1.3	-0.8	A
Thermal shutdown ⁽⁵⁾	T _{SD}	Temperature rising		170		°C
Thermal shutdown hysteresis ⁽⁵⁾	T _{SD-SYS}			25		°C

Note:

5) Derived from the bench characterization and not tested in production.

TYPICAL CHARACTERISTICS

$V_{IN} = 24V$, $T_J = -40^{\circ}C$ to $+125^{\circ}C$, unless otherwise noted.

Quiescent Current vs. Temperature

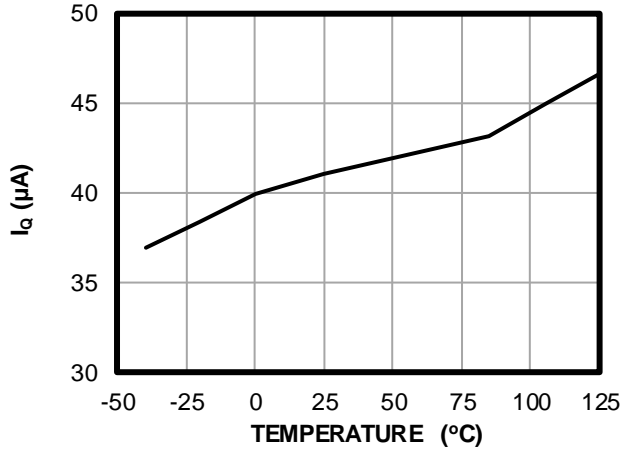

Shutdown Current vs. Temperature

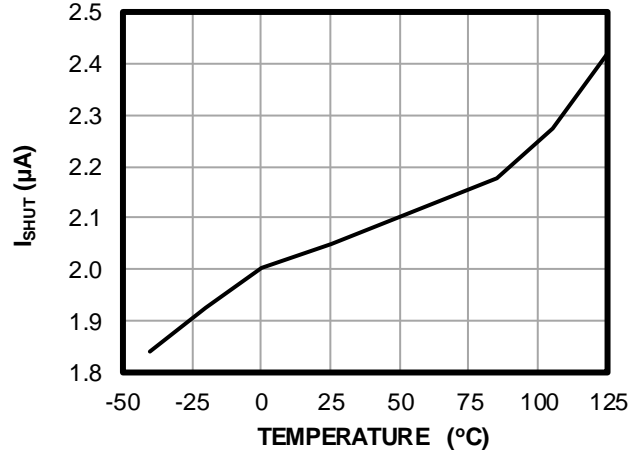

V_{IN} UVLO Threshold vs. Temperature

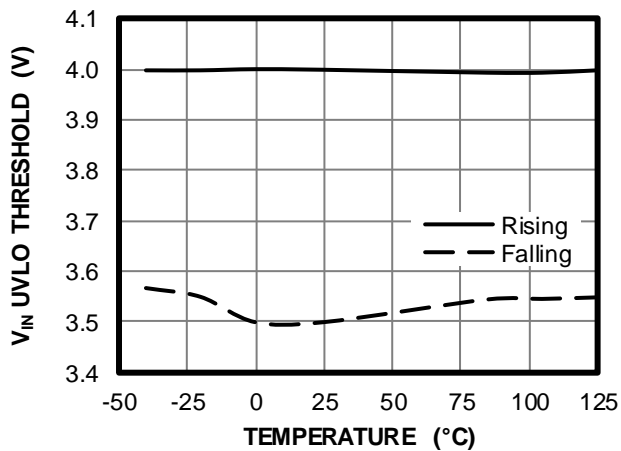

Feedback Reference vs. Temperature

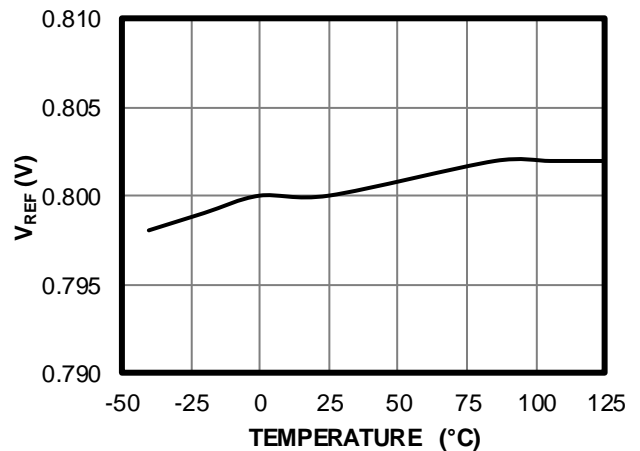

V_{CC} vs. Temperature

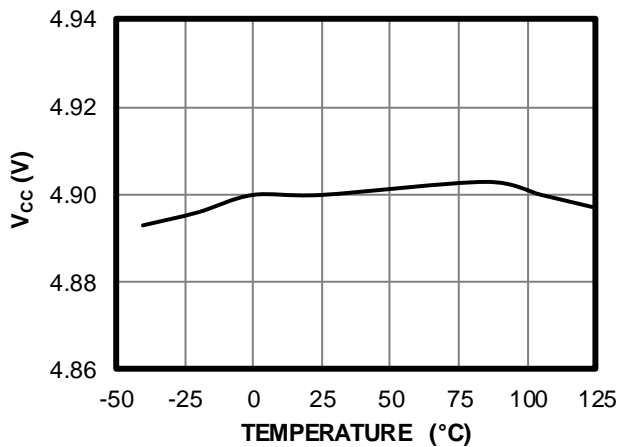

EN Threshold vs. Temperature

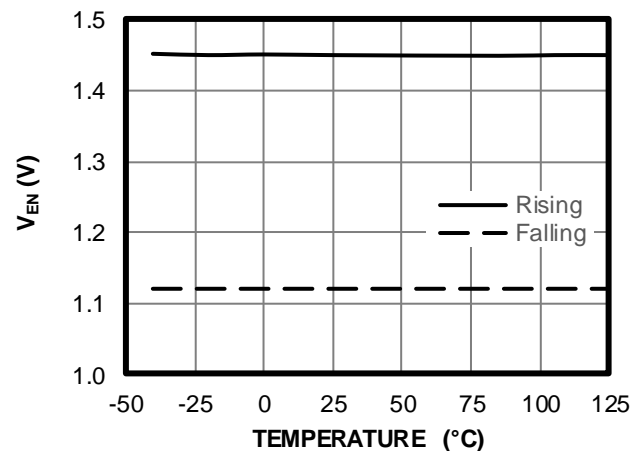

TYPICAL CHARACTERISTICS (continued)
 $V_{IN} = 24V$, $T_J = -40^{\circ}C$ to $+125^{\circ}C$, unless otherwise noted.

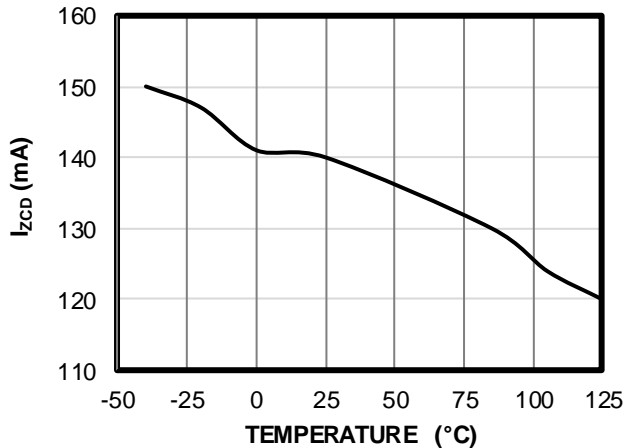
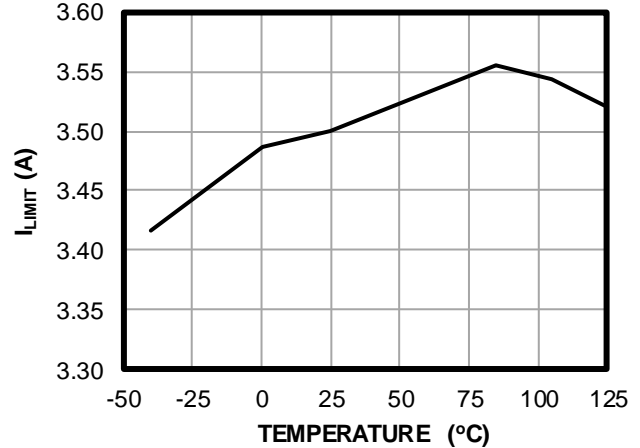
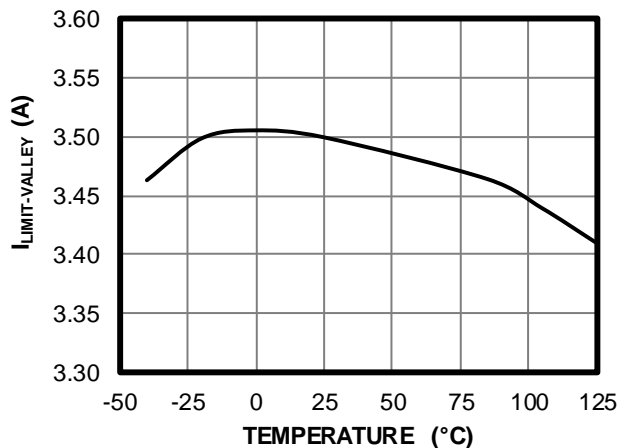
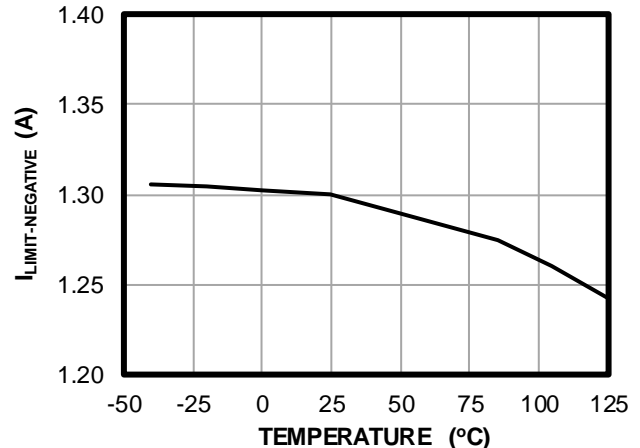
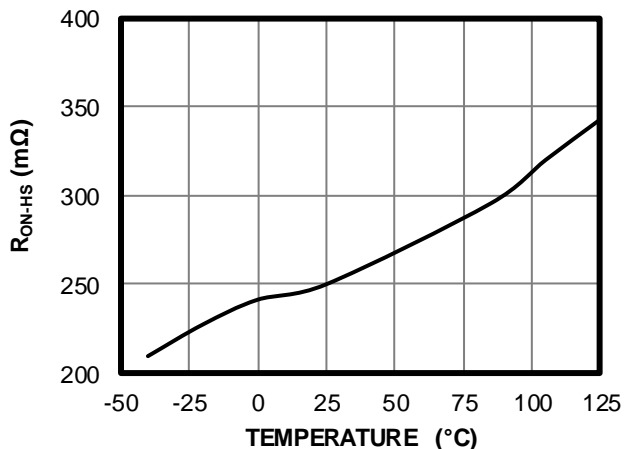
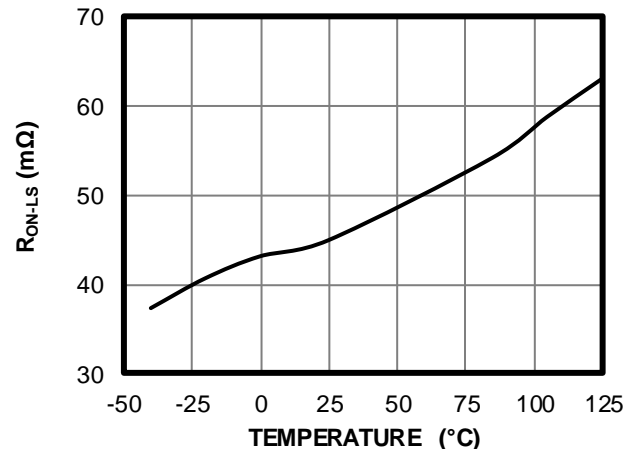
Zero-Current Detection (ZCD) vs. Temperature

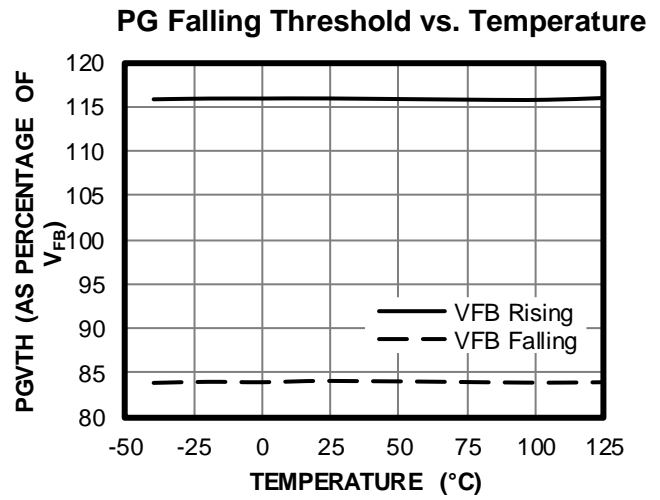
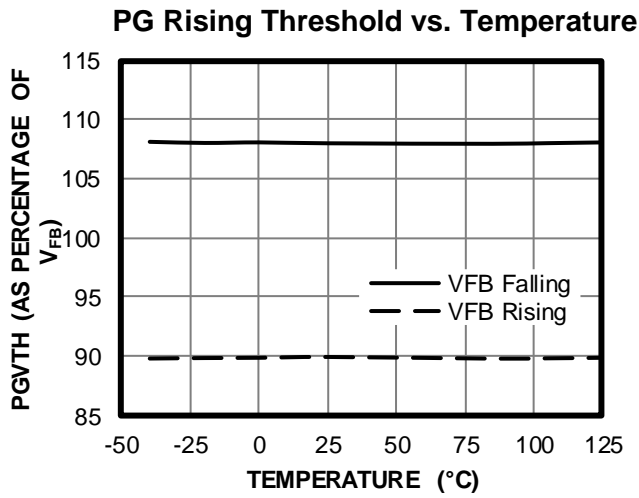
Peak Current Limit vs. Temperature

Valley Current Limit vs. Temperature

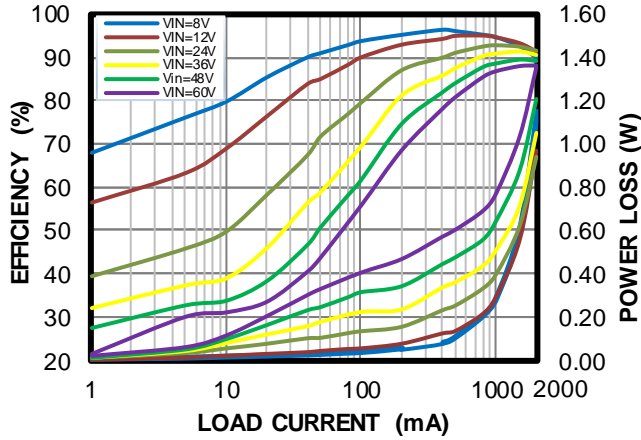
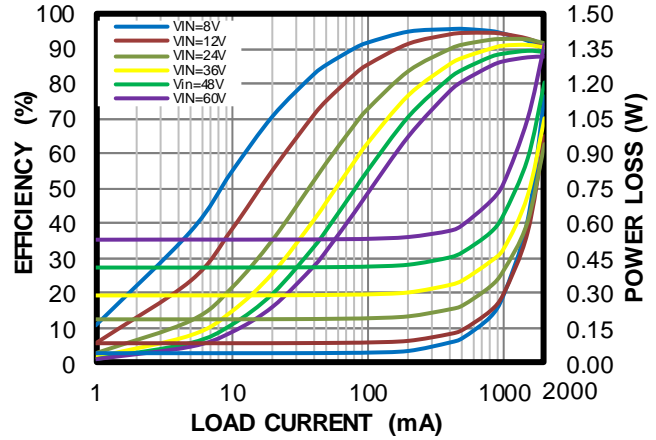
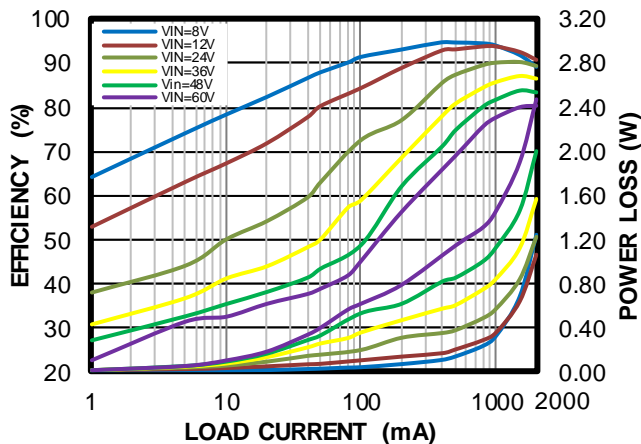
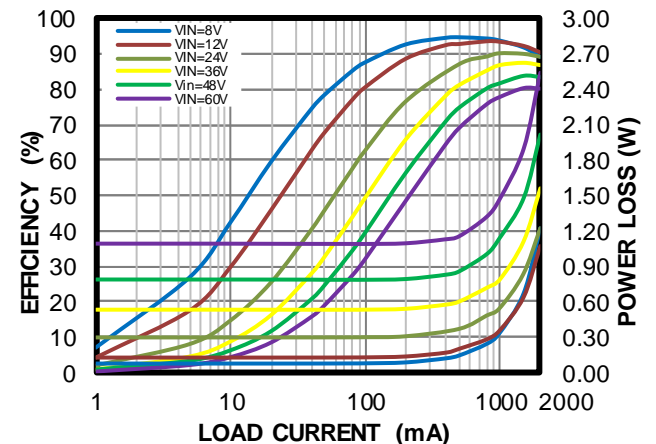
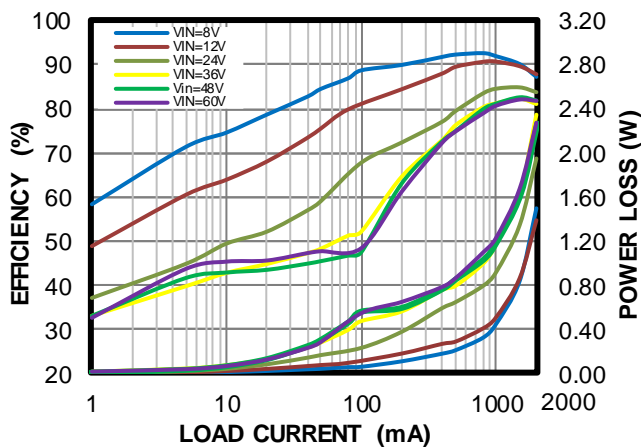
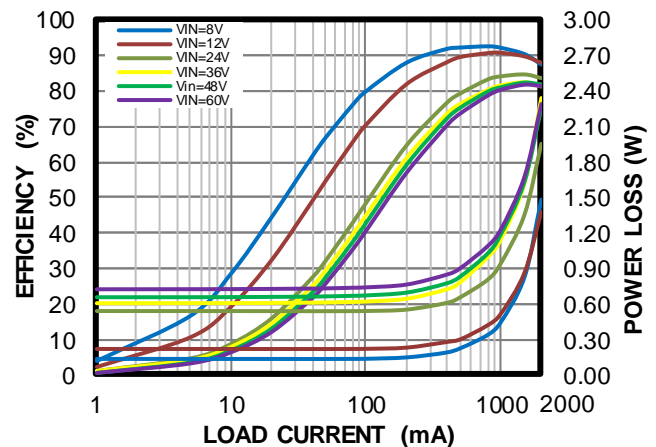
Negative Current Limit vs. Temperature

HS-FET On Resistance vs. Temperature

LS-FET On Resistance vs. Temperature

TYPICAL CHARACTERISTICS (continued)
 $V_{IN} = 24V$, $T_J = -40^{\circ}C$ to $+125^{\circ}C$, unless otherwise noted.

TYPICAL PERFORMANCE CHARACTERISTICS (continued)
 $V_{IN} = 24V$, $V_{OUT} = 5V$, $L = 15\mu H$, $f_{sw} = 400kHz$, AAM, $T_A = 25^\circ C$, unless otherwise noted.

Efficiency vs. Load Current
 $f_{sw} = 400kHz$, $L = 15\mu H$, AAM

Efficiency vs. Load Current
 $f_{sw} = 400kHz$, $L = 15\mu H$, CCM

Efficiency vs. Load Current
 $f_{sw} = 1MHz$, $L = 10\mu H$, AAM

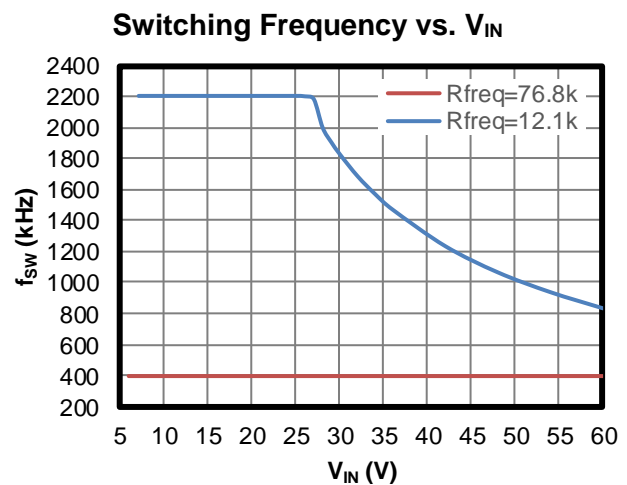
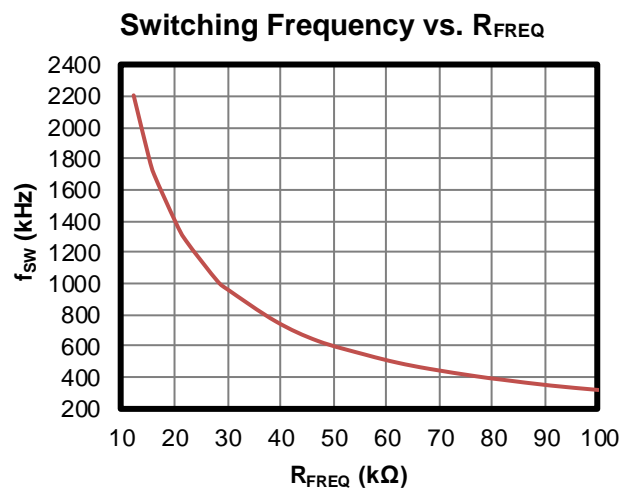
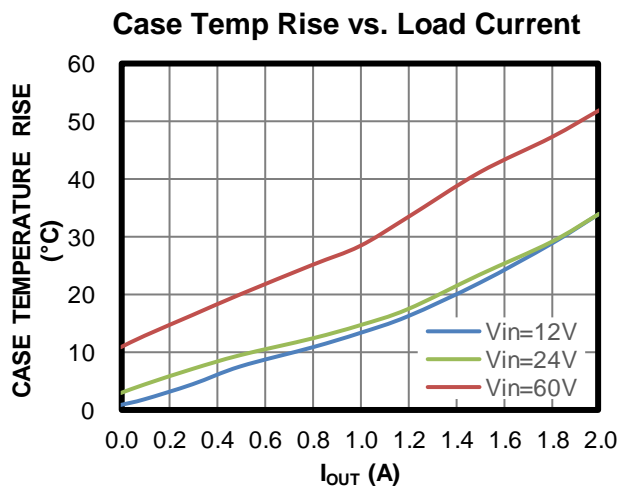
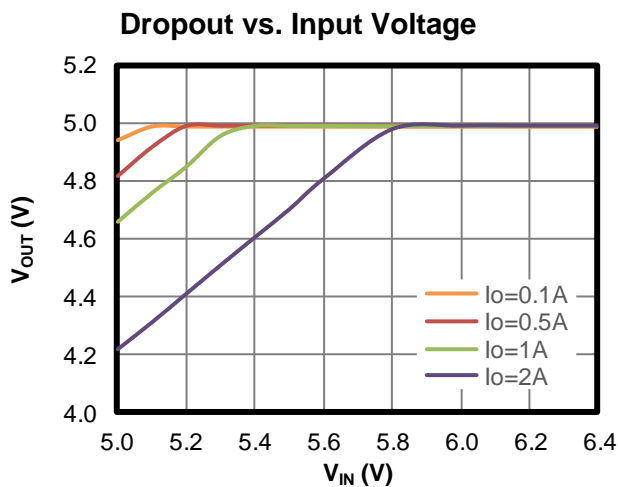
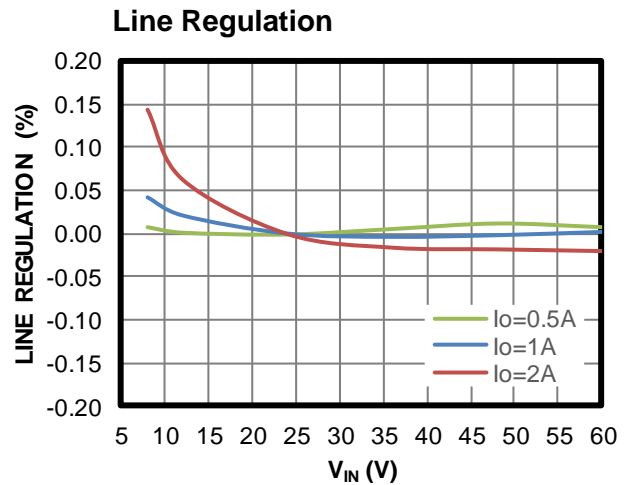
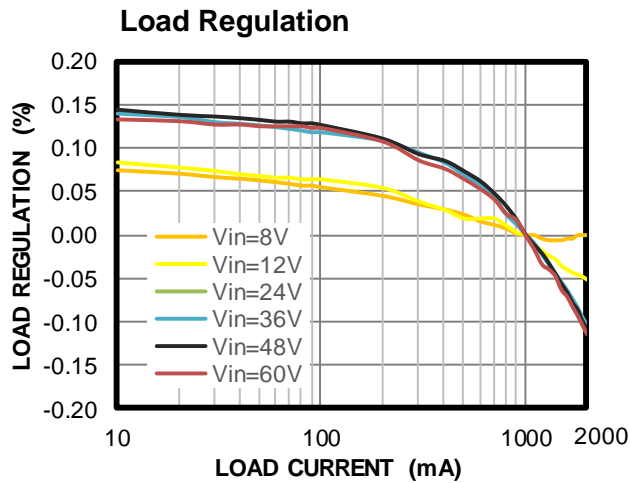
Efficiency vs. Load Current
 $f_{sw} = 1MHz$, $L = 10\mu H$, CCM

Efficiency vs. Load Current
 $f_{sw} = 2.2MHz$, $L = 4.7\mu H$, AAM

Efficiency vs. Load Current
 $f_{sw} = 2.2MHz$, $L = 4.7\mu H$, CCM

TYPICAL PERFORMANCE CHARACTERISTICS *(continued)*

$V_{IN} = 24V$, $V_{OUT} = 5V$, $L = 15\mu H$, $f_{SW} = 400kHz$, AAM, $T_A = 25^\circ C$, unless otherwise noted.



TYPICAL PERFORMANCE CHARACTERISTICS *(continued)*

$V_{IN} = 24V$, $V_{OUT} = 5V$, $L = 15\mu H$, $f_{SW} = 400kHz$, AAM, $T_A = 25^\circ C$, unless otherwise noted. ⁽⁶⁾

CISPR25 Class 5 Peak Conducted Emissions

150kHz to 108MHz

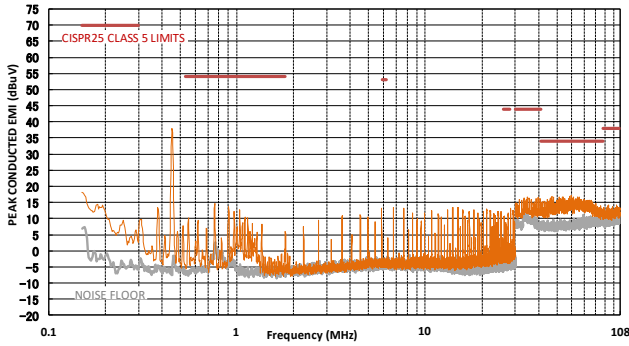

CISPR25 Class 5 Average Conducted Emissions

150kHz to 108MHz

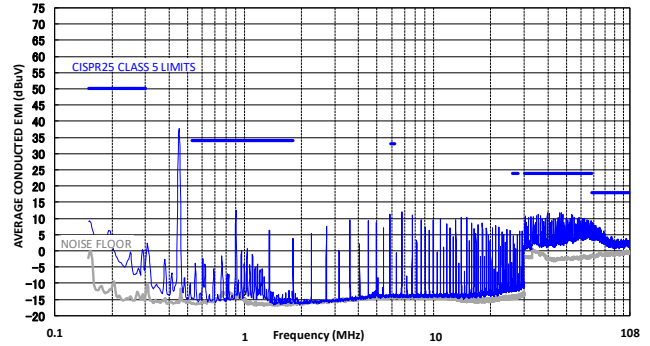

PR25 Class 5 Peak Radiated Emissions

150kHz to 30MHz

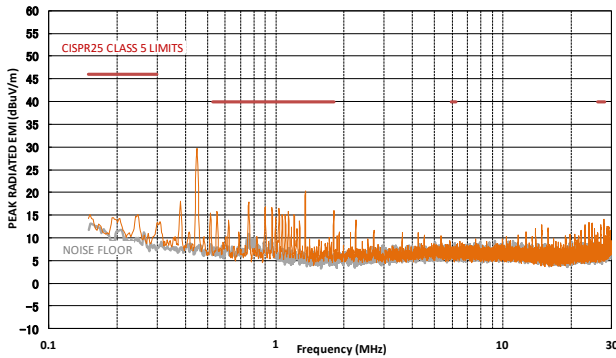

CISPR25 Class 5 Average Radiated Emissions

150kHz to 30MHz

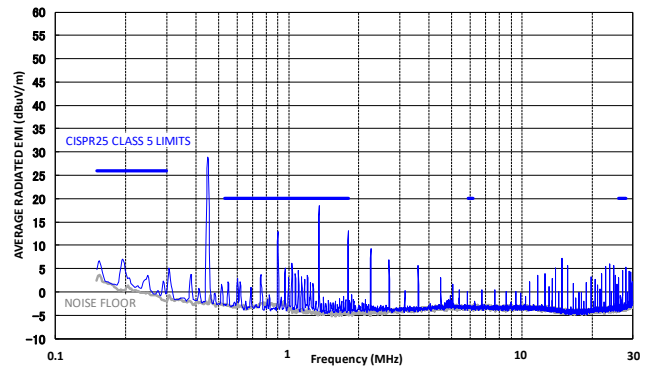

CISPR25 Class 5 Peak Radiated Emissions

Horizontal, 30MHz to 200MHz

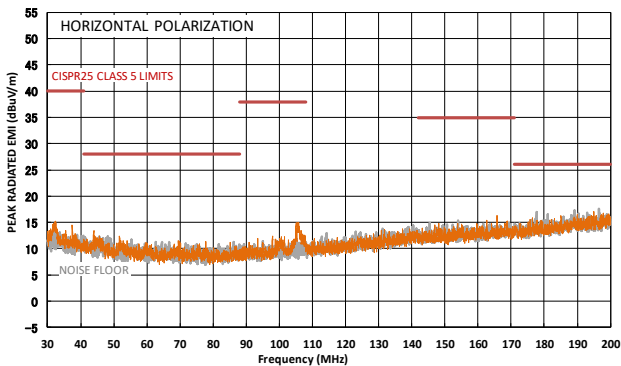

CISPR25 Class 5 Average Radiated Emissions

Horizontal, 30MHz to 200MHz

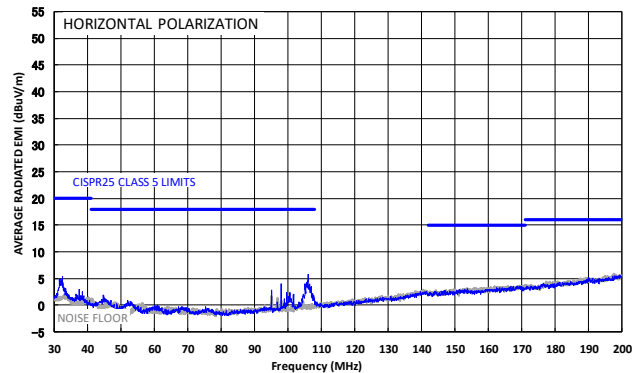

TYPICAL PERFORMANCE CHARACTERISTICS *(continued)*

$V_{IN} = 12V$, $V_{OUT} = 5V$, $L = 15\mu H$, $f_{SW} = 450kHz$, AAM, $T_A = 25^\circ C$, unless otherwise noted. ⁽⁶⁾

CISPR25 Class 5 Peak Radiated Emissions

Vertical, 30MHz to 200MHz

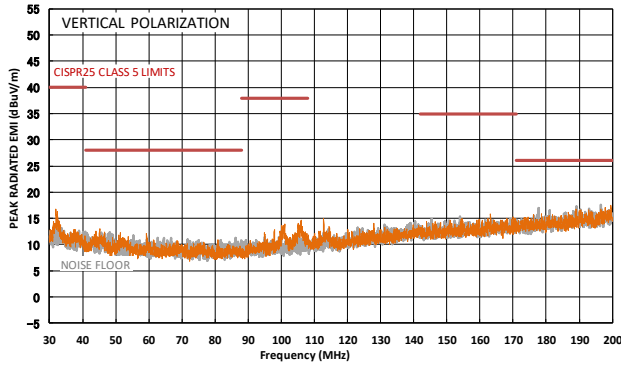

CISPR25 Class 5 Average Radiated Emissions

Vertical, 30MHz to 200MHz

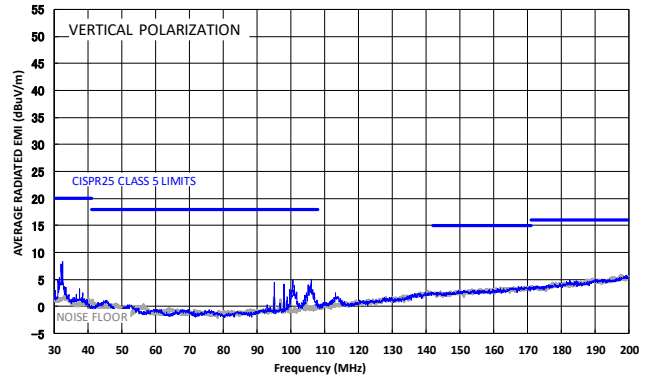

CISPR25 Class 5 Peak Radiated Emissions

Horizontal, 200MHz to 1GHz

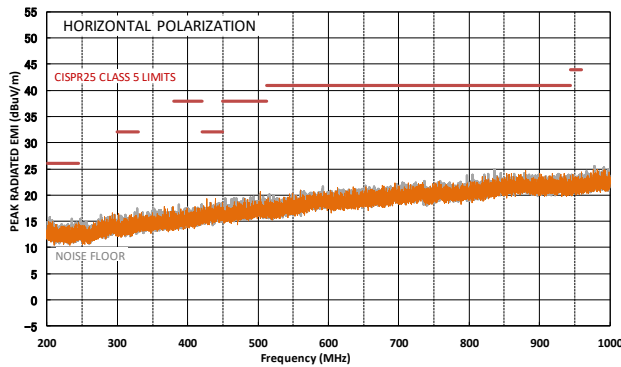

CISPR25 Class 5 Average Radiated Emissions

Horizontal, 200MHz to 1GHz

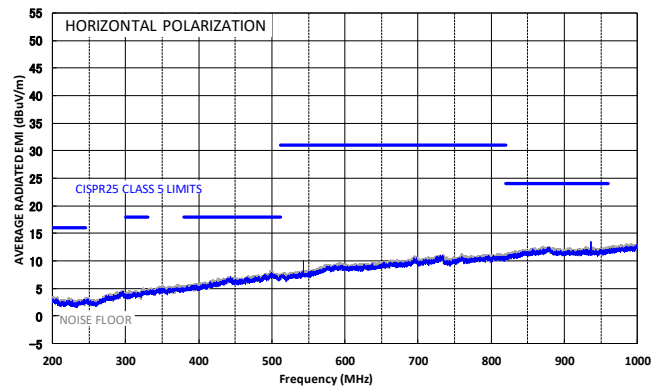

CISPR25 Class 5 Peak Radiated Emissions

Vertical, 200MHz to 1GHz

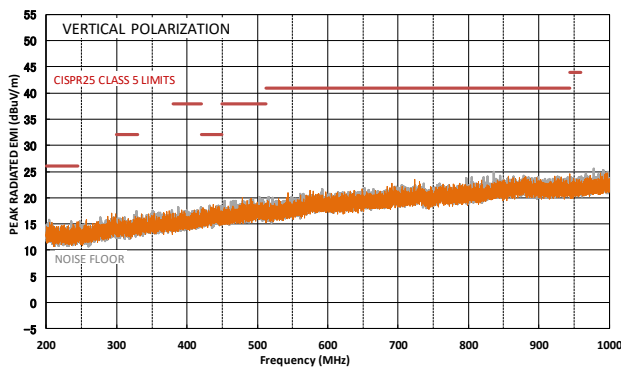

CISPR25 Class 5 Average Radiated Emissions

Vertical, 200MHz to 1GHz

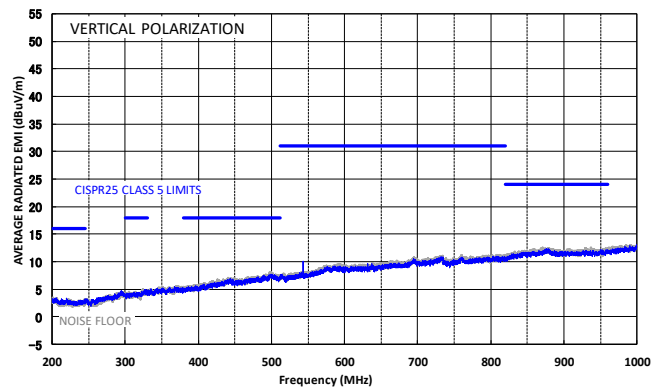

Note:

6) The EMC test results are based on the application circuit with an EMI filter (see Figure 8) and tested on the EVQ4572-QB-00A.

TYPICAL PERFORMANCE CHARACTERISTICS (continued)
 $V_{IN} = 24V$, $V_{OUT} = 5V$, $L = 15\mu H$, $f_{SW} = 400kHz$, $T_A = 25^\circ C$, unless otherwise noted.

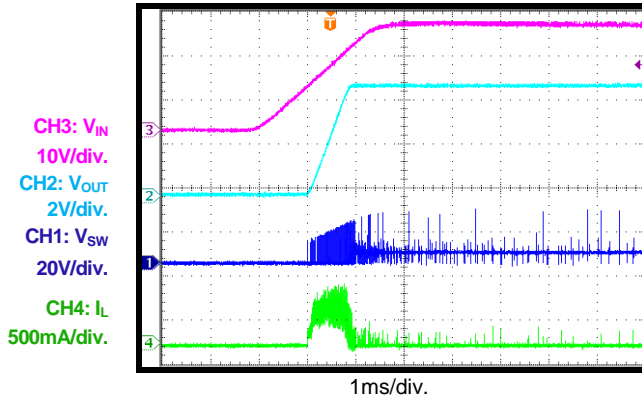
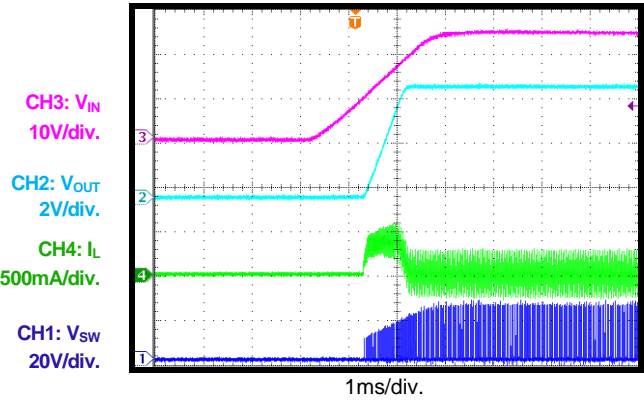
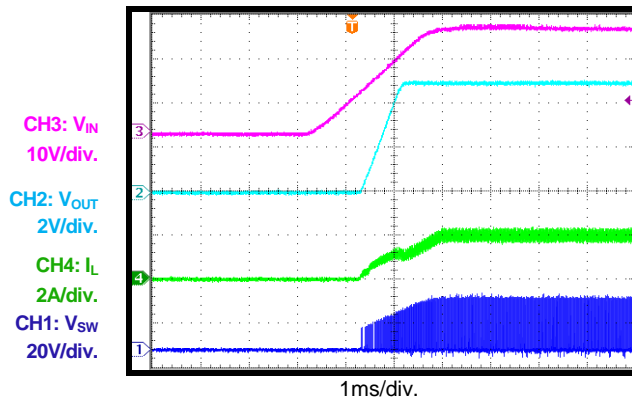
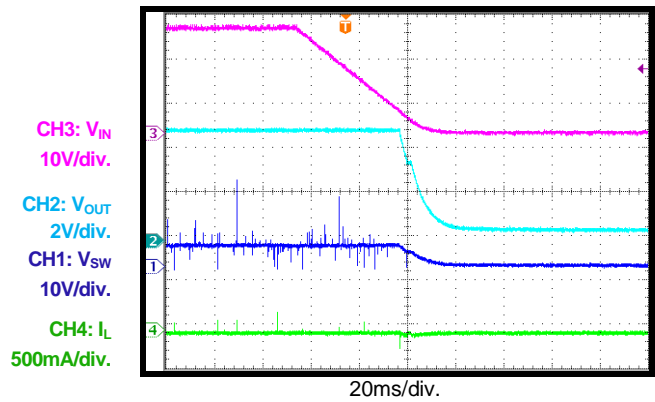
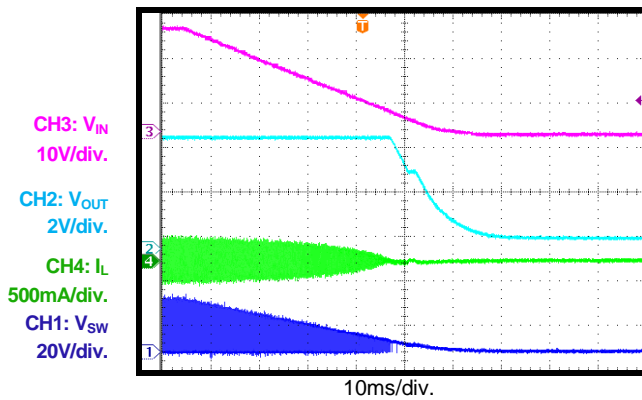
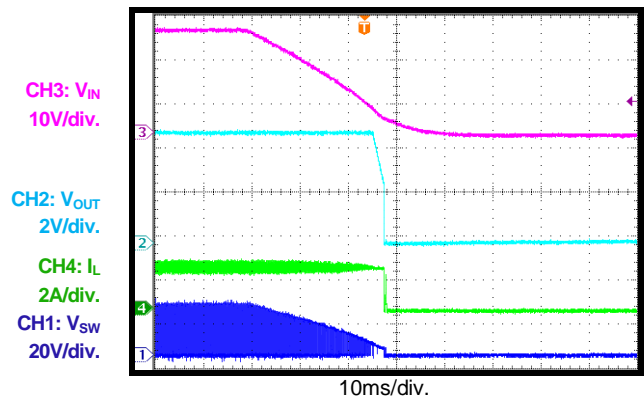
Start-Up through Input Voltage
 $I_{OUT} = 0A$, AAM

Start-Up through Input Voltage
 $I_{OUT} = 0A$, CCM

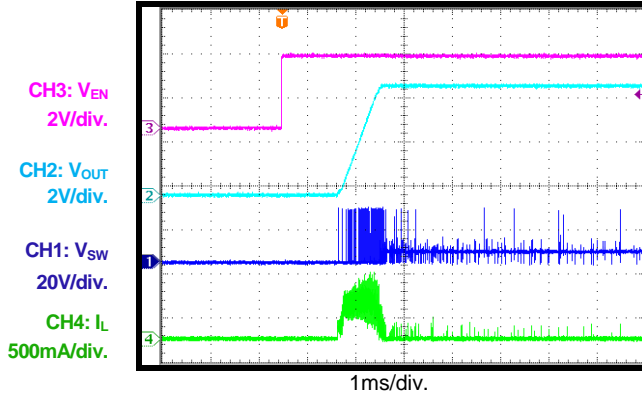
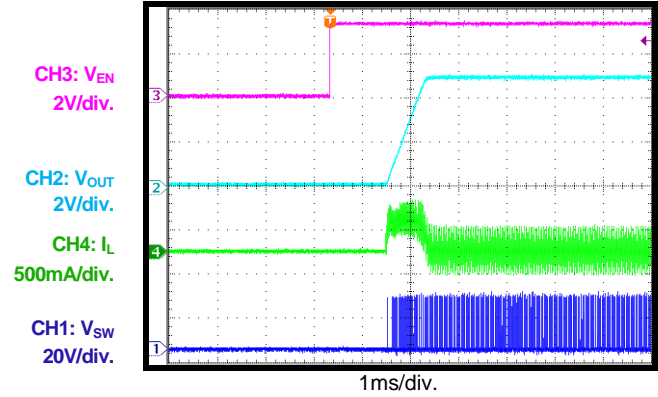
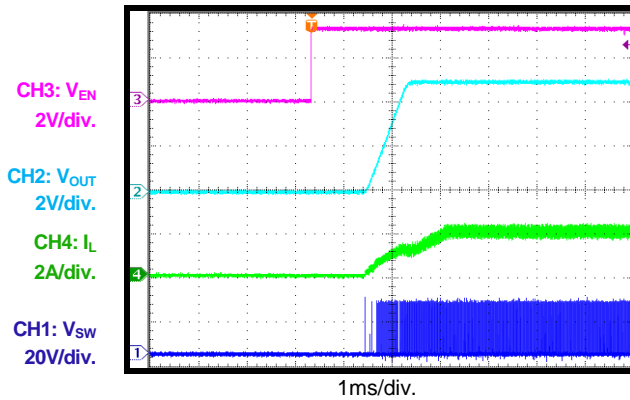
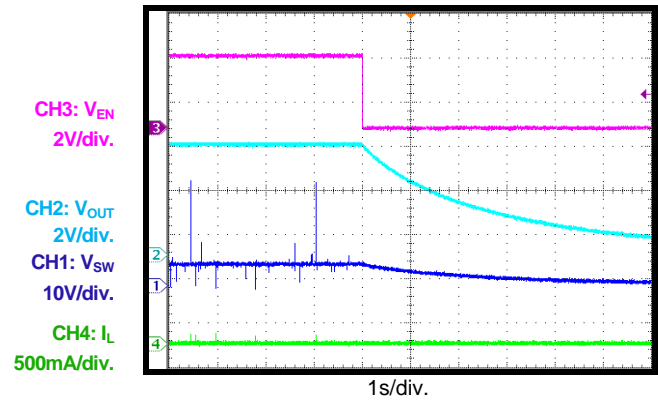
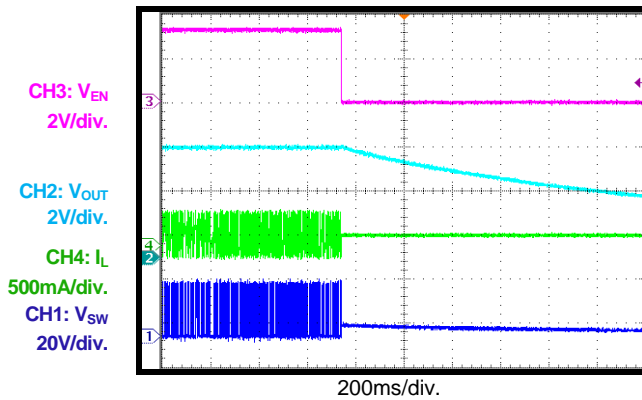
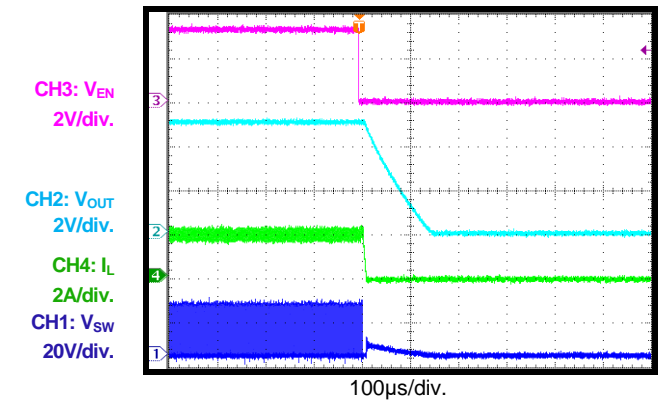
Start-Up through Input Voltage
 $I_{OUT} = 2A$

Shutdown through Input Voltage
 $I_{OUT} = 0A$, AAM

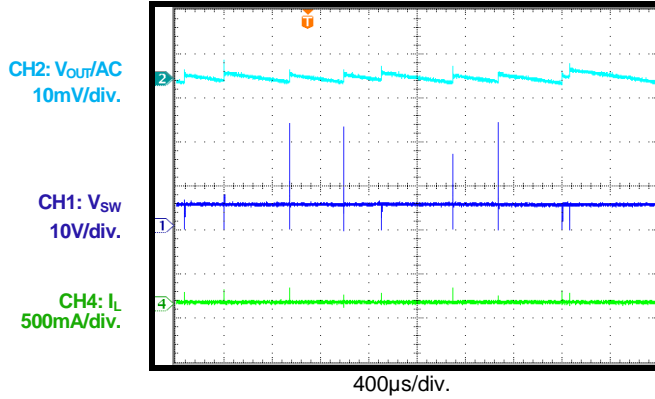
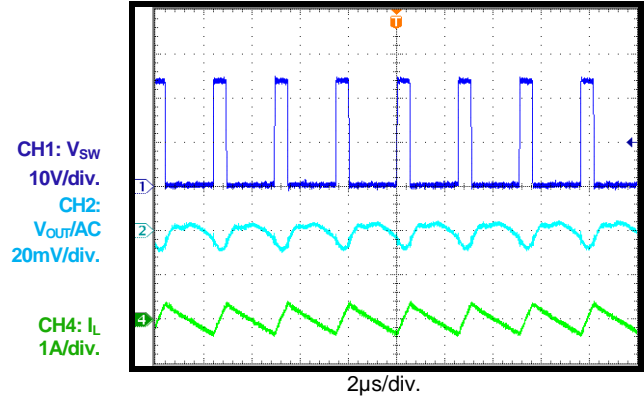
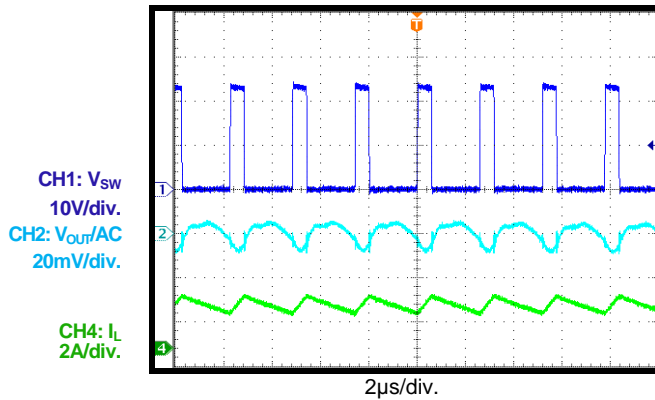
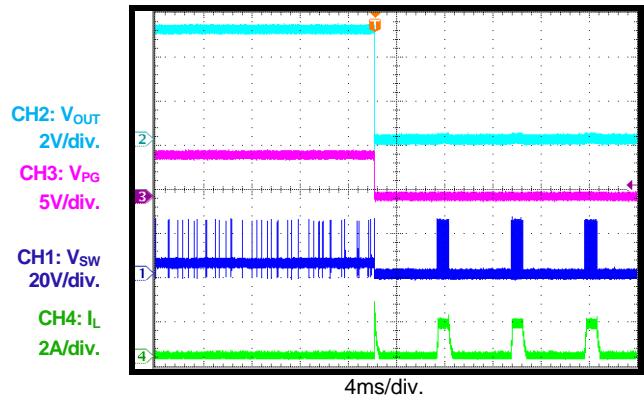
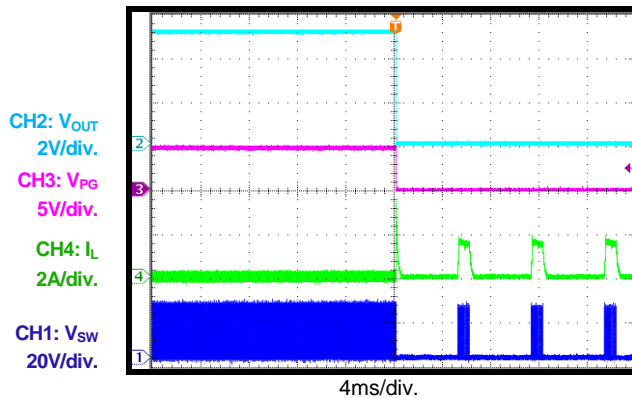
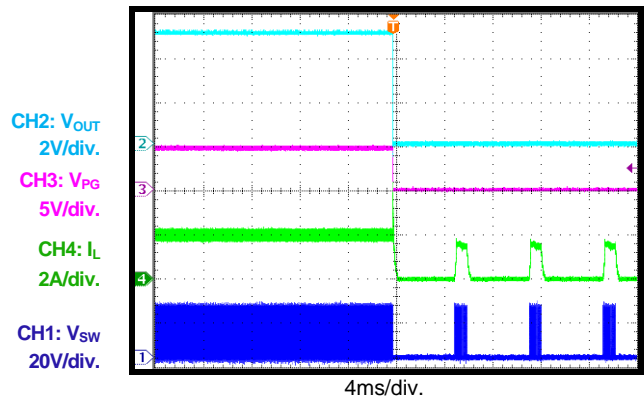
Shutdown through Input Voltage
 $I_{OUT} = 0A$, CCM

Shutdown through Input Voltage
 $I_{OUT} = 2A$

TYPICAL PERFORMANCE CHARACTERISTICS (continued)
 $V_{IN} = 24V$, $V_{OUT} = 5V$, $L = 15\mu H$, $f_{SW} = 400kHz$, $T_A = 25^\circ C$, unless otherwise noted.

Start-Up through EN
 $I_{OUT} = 0A$, AAM

Start-Up through EN
 $I_{OUT} = 0A$, CCM

Start-Up through EN
 $I_{OUT} = 2A$

Shutdown through EN
 $I_{OUT} = 0A$, AAM

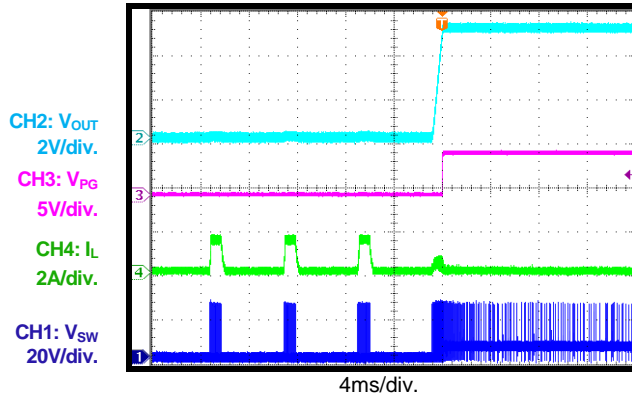
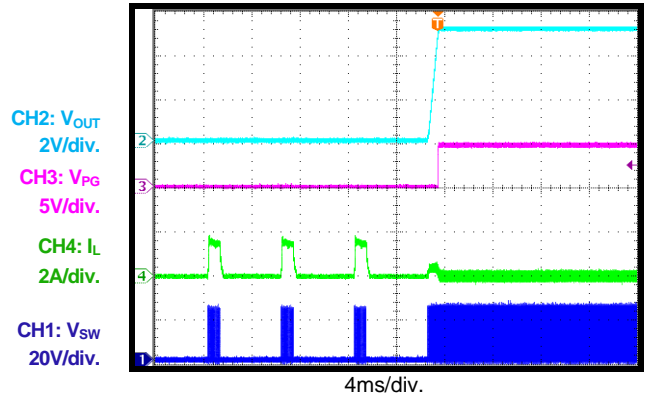
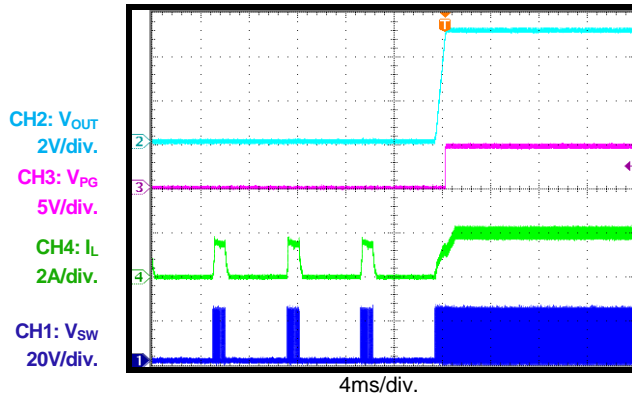
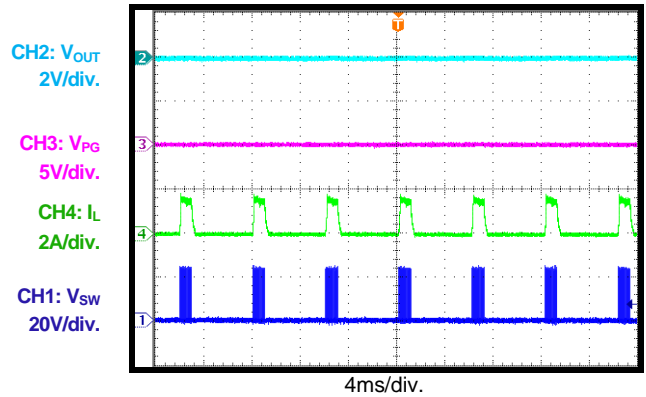
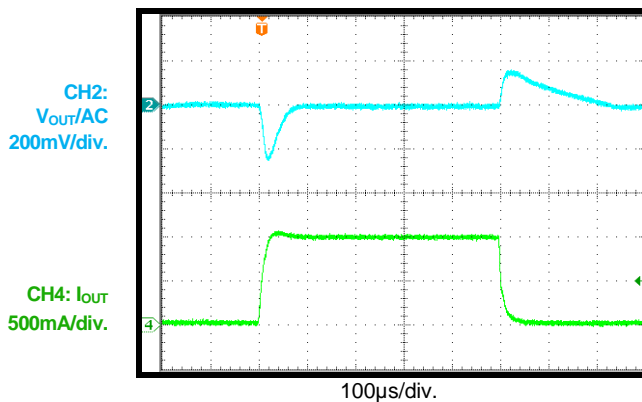
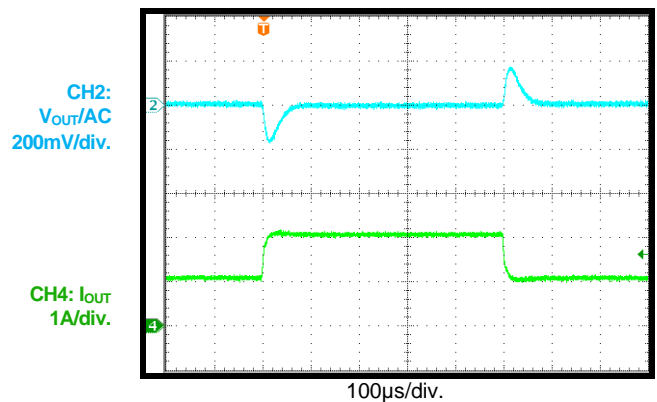
Shutdown through EN
 $I_{OUT} = 0A$, CCM

Shutdown through EN
 $I_{OUT} = 2A$

TYPICAL PERFORMANCE CHARACTERISTICS (continued)
 $V_{IN} = 24V$, $V_{OUT} = 5V$, $L = 15\mu H$, $f_{sw} = 400kHz$, $T_A = 25^\circ C$, unless otherwise noted.

Output Ripple
 $I_{OUT} = 0A$, AAM

Output Ripple
 $I_{OUT} = 0A$, CCM

Output Ripple
 $I_{OUT} = 2A$

Short-Circuit Protection (SCP) Entry
 $I_{OUT} = 0A$, AAM

Short-Circuit Protection (SCP) Entry
 $I_{OUT} = 0A$, CCM

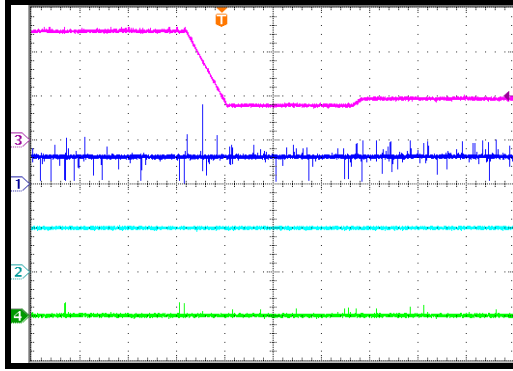
Short-Circuit Protection (SCP) Entry
 $I_{OUT} = 2A$

TYPICAL PERFORMANCE CHARACTERISTICS (continued)
 $V_{IN} = 24V$, $V_{OUT} = 5V$, $L = 15\mu H$, $f_{sw} = 400kHz$, $T_A = 25^\circ C$, unless otherwise noted.

**Short-Circuit Protection (SCP)
Recovery**
 $I_{OUT} = 0A$, AAM

**Short-Circuit Protection (SCP)
Recovery**
 $I_{OUT} = 0A$, CCM

**Short-Circuit Protection (SCP)
Recovery**
 $I_{OUT} = 2A$

**Short-Circuit Protection (SCP)
Steady State**

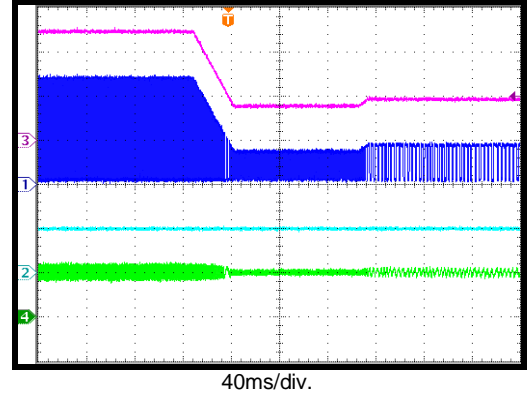
Load Transient
 $I_{OUT} = 0A$ to $1A$, AAM

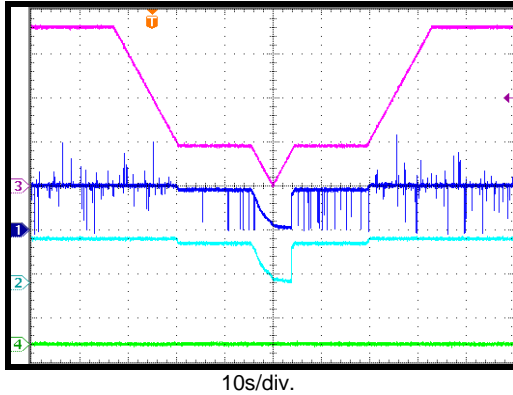
Load Transient
 $I_{OUT} = 1A$ to $2A$, AAM

TYPICAL PERFORMANCE CHARACTERISTICS (continued)
 $V_{IN} = 24V$, $V_{OUT} = 5V$, $L = 15\mu H$, $f_{SW} = 400kHz$, $T_A = 25^\circ C$, unless otherwise noted.

Cold Crank
 $V_{IN} = 24V$ to $4V$ to $5V$, $I_{OUT} = 0A$

 CH3: V_{IN}
 10V/div.
 CH1: V_{SW}
 10V/div.
 CH2: V_{OUT}
 5V/div.
 CH4: I_L
 500mA/div.

Cold Crank
 $V_{IN} = 24V$ to $4V$ to $5V$, $I_{OUT} = 2A$

 CH3: V_{IN}
 10V/div.
 CH1: V_{SW}
 10V/div.
 CH2: V_{OUT}
 5V/div.
 CH4: I_L
 2A/div.

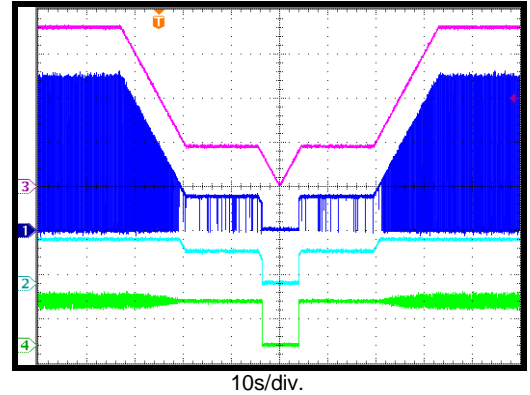
VIN Ramp Down and Up
 $V_{IN} = 18V$ to $4.5V$ to $0V$ to $4.5V$ to $18V$,
 $I_{OUT} = 0A$

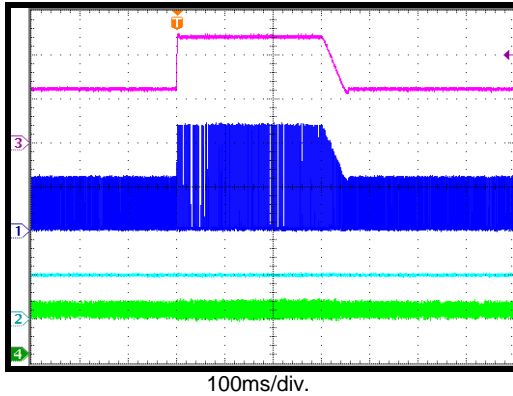
 CH3: V_{IN}
 5V/div.
 CH1: V_{SW}
 5V/div.
 CH2: V_{OUT}
 5V/div.
 CH4: I_L
 2A/div.

VIN Ramp Down and Up
 $V_{IN} = 18V$ to $4.5V$ to $0V$ to $4.5V$ to $18V$,
 $I_{OUT} = 2A$

 CH3: V_{IN}
 5V/div.
 CH1: V_{SW}
 5V/div.
 CH2: V_{OUT}
 5V/div.
 CH4: I_L
 2A/div.

Load Dump
 $V_{IN} = 24V$ to $48V$ to $24V$, $I_{OUT} = 2A$

 CH3: V_{IN}
 20V/div.
 CH1: V_{SW}
 20V/div.
 CH2: V_{OUT}
 5V/div.
 CH4: I_L
 2A/div.

FUNCTIONAL BLOCK DIAGRAM

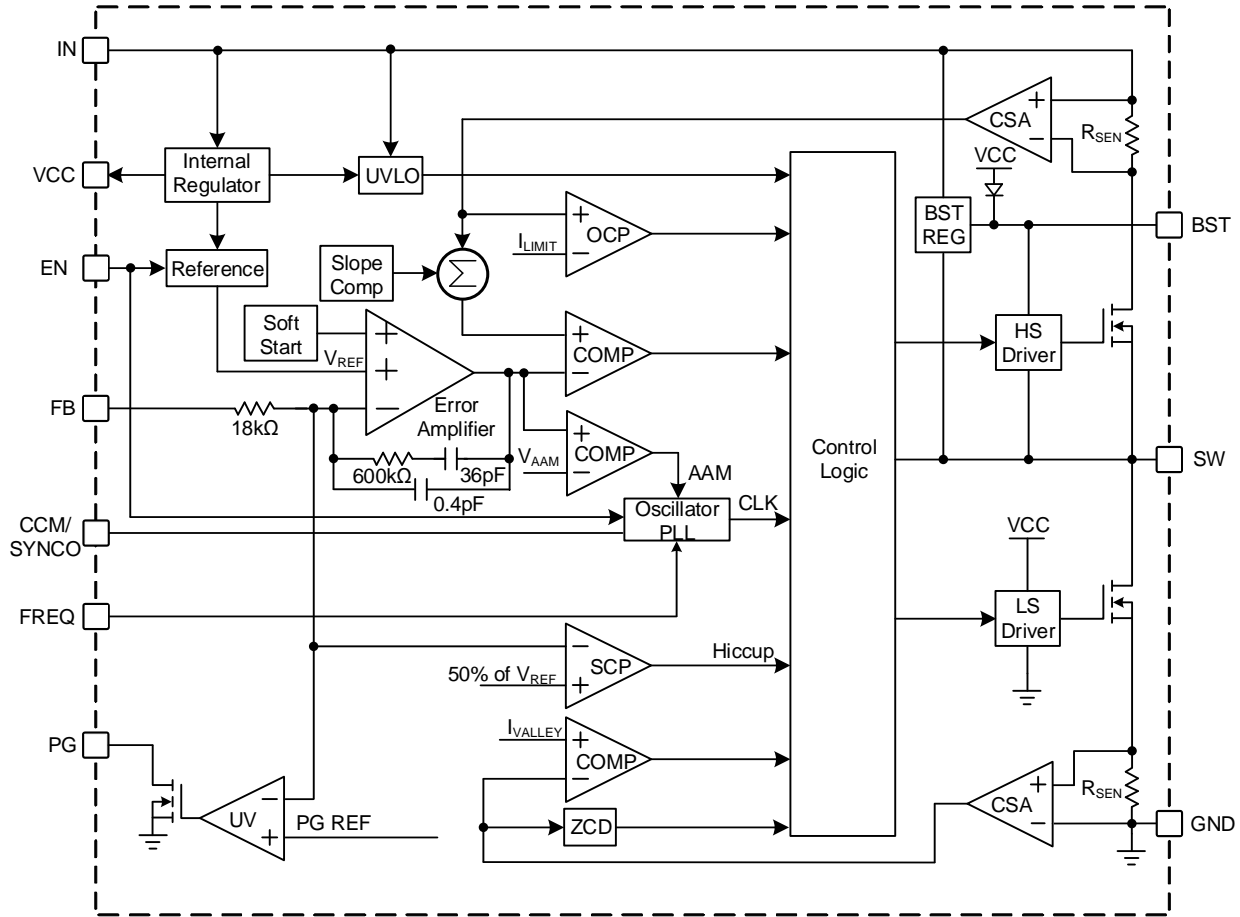

Figure 1: Functional Block Diagram

OPERATION

The MPQ4572 is a fully integrated, synchronous, rectified, step-down, non-isolated switch-mode converter. It is available with a wide 4.5V to 60V input supply range, and can achieve up to 2A of continuous output current with excellent load and line regulation over an ambient temperature range of -40°C to $+125^{\circ}\text{C}$. Figure 1 shows a block diagram of the device.

PWM Control

At moderate to high output currents, the MPQ4572 operates in a fixed-frequency, peak current control mode to regulate the output voltage.

An internal clock initiates a PWM cycle. At the rising edge of the clock, the high-side switch (HS-FET) turns on, and the inductor current rises linearly to provide energy to the load. The HS-FET remains on until its current reaches the value set by the COMP voltage (V_{COMP}), which is the output of the internal error amplifier. V_{COMP} is based on the difference between the output feedback voltage and internal high-precision reference. V_{COMP} determines how much energy should be transferred to the load. A higher load current creates a higher V_{COMP} . Once the HS-FET is on, it remains on for at least 90ns.

When the HS-FET is off, the low-side switch (LS-FET) turns on immediately, and stays on until the next clock starts. During this time, the inductor current flows through the LS-FET. Once the LS-FET is on, it remains on for at least 100ns before the next cycle starts. To avoid shoot-through, a dead time is inserted to prevent the HS-FET and LS-FET from turning on simultaneously.

If the current in the HS-FET does not reach the value set by COMP within one PWM period, the HS-FET remains on, saving a turn-off operation.

Light-Load Operation

The MPQ4572 features configurable forced continuous conduction mode (FCCM) and light-load asynchronous advanced mode (AAM), which can be set by the CCM/SYNCO pin. FCCM maintains a constant switching frequency and smaller output ripple. However, FCCM has low efficiency during light-load conditions, while AAM achieves high efficiency (see Figure 2).

To force the device into FCCM, connect the CCM/SYNCO pin to GND using a resistor between $10\text{k}\Omega$ and $300\text{k}\Omega$. In FCCM, the converter works with a fixed frequency across a no-load to full-load range. Float the CCM/SYNCO pin to force the device into AAM under light-load conditions. The device cannot change modes while it is operating, so the mode must be selected before start-up.

When AAM is enabled, the switching frequency is scaled down according to V_{COMP} during light-load conditions. The MPQ4572 first enters non-synchronous operation while the inductor current approaches zero at light-load. If the load further decreases or is at no-load, V_{COMP} drops below the internally set AAM value (V_{AAM}). The MPQ4572 then enters sleep mode and consumes a low quiescent current to improve light-load efficiency.

In sleep mode, the internal clock is blocked, so the MPQ4572 skips some pulses. V_{FB} is below V_{REF} , so V_{COMP} ramps up until it exceeds V_{AAM} . Then the internal clock is reset and the crossover time is used as a benchmark for the next clock. This control scheme helps the device achieve high efficiency by scaling down the frequency to reduce the switching and gate driver losses.

As the output current increases from light-load, both V_{COMP} and the switching frequency rise. If the output current exceeds the critical level set by V_{COMP} , the MPQ4572 enters discontinuous conduction operation (DCM) or CCM, which has a constant switching frequency.

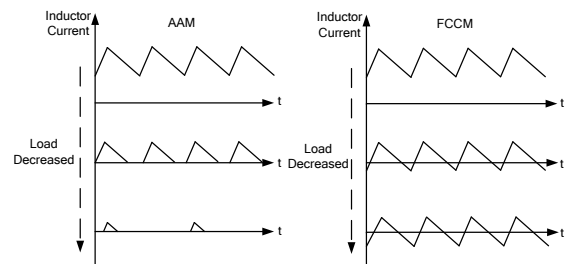

Figure 2: AAM and FCCM

Enable (EN) Control

The MPQ4572 can be enabled or disabled via a remote EN signal that is referenced to ground. The remote EN control operates with a positive logic that is compatible with popular logic devices.

Positive logic indicates that when the input voltage exceeds the under-voltage lockout (UVLO) threshold (about 4.0V), the converter is enabled by pulling the EN pin above 1.45V. Drive the EN pin below 1.12V to disable the MPQ4572. An internal resistor (R_{EN}) from EN to GND allows EN to be floated to shut down the chip ($R_{EN} = 2.8M\Omega$ when EN is on; $R_{EN} = 1.8M\Omega$ when EN is off).

SYNC OUT (SYNCO)

The MPQ4572 has a SYNCO pin. During start-up, SYNCO stays low and quickly outputs a 180° phase-shift clock to the internal oscillator once soft start is ready. Note that the falling edge of SYNCO is a 180° phase-shift to the rising edge of the internal oscillator. This function allows two devices to operate in the same frequency, but 180° out of phase, which reduces the total input current ripple. This allows a smaller input bypass capacitor to be used.

Internal Regulator

A 4.9V internal regulator powers most of the internal circuitries. This regulator takes V_{IN} and operates in the full V_{IN} range. When V_{IN} exceeds 4.9V, the output of the regulator is in full regulation. Lower V_{IN} values result in lower output voltages. The regulator is enabled when V_{IN} exceeds its UVLO threshold and EN is high. In EN shutdown mode, the internal VCC regulator is disabled to reduce power dissipation.

Frequency Programmable and Foldback

The oscillating frequency (f_{SW}) of the MPQ4572 is programmed by an external frequency resistor. The frequency resistor should be located between the FREQ pin and GND, as close as possible to the device. Select a proper R_{FREQ} , calculated with Equation (1):

$$R_{FREQ} (M\Omega) = \frac{30}{f_{sw}(kHz)} \quad (1)$$

The calculated resistance may need fine tuning with a bench test.

It is not possible to use a high f_{SW} with a high V_{IN} , since the minimum on time required for the HS-FET is limited. The MPQ4572 control loop automatically sets the maximum possible f_{SW} up to the set frequency, which also reduces excessive power loss in the IC. V_{OUT} is regulated by varying the duration of the switch-off time of the HS-FET, which results in an automatic reduction of f_{SW} .

Compliance with the minimum on time of the HS-FET is guaranteed. An advantage of this method is that the device works at the desired f_{SW} as long as possible, and a correction is only made at high V_{IN} . For the Switching Frequency vs. V_{IN} curve, see the Typical Performance Characteristics section on page 11, where R_{FREQ} equals 12.1kHz.

Internal Soft Start (SS)

To avoid overshoot during start-up, the MPQ4572 has built-in soft start (SS) that ramps up the output voltage at a controlled slew rate when the EN pin goes high. When the SS voltage (V_{SS}) is below the internal reference (V_{REF}), V_{SS} overrides V_{REF} as the error amplifier reference. When V_{SS} exceeds V_{REF} , V_{REF} acts as the reference. At this point, soft start finishes, and the MPQ4572 enters steady-state.

The SS time is internally set to 0.45ms. When the output voltage is shorted to GND, the feedback voltage is pulled low, then V_{SS} is discharged. The part will soft start again when it returns to the normal state.

Pre-Biased Start-Up

If V_{FB} exceeds V_{SS} during start-up, the output has a pre-biased voltage and neither the HS-FET nor LS-FET turns on until V_{SS} exceeds V_{FB} . Note that this capability is only available when the device is set to AAM.

Power Good (PG) Indicator

The MPQ4572 has power good (PG) indication. The PG pin is the open drain of a MOSFET. It should be connected to a voltage source through a resistor (e.g. 100k Ω). In the presence of an input voltage, the MOSFET turns on so that the PG pin is pulled to GND before soft start is ready. PG goes high if the output voltage is within 90% to 108% of the nominal voltage after a 70 μ s delay. PG goes low when the output voltage is above 116% or below 84% of the nominal voltage after a 25 μ s delay.

Under-Voltage Lock-Out (UVLO) Protection

The MPQ4572 has input under-voltage lockout protection (UVLO) to ensure reliable output power. Assuming EN is active, the MPQ4572 is powered on when the input voltage exceeds the UVLO rising threshold. The device is powered off when input voltage drops below the UVLO falling threshold. This function prevents the device from

operating at an insufficient voltage. It is a non-latch protection.

Over-Current Protection (OCP)

The MPQ4572 has a 3.5A peak current limit. Once the inductor current reaches the current limit, the HS-FET turns off immediately. Then the LS-FET turns on to discharge the energy, and the inductor current decreases. The HS-FET does not turn on again until the inductor current drops below a current threshold (the valley current limit). This protection prevents the inductor current from running away and damaging the components.

Short-Circuit Protection (SCP)

When a short-circuit condition occurs, the MPQ4572 hits its current limit immediately. Meanwhile, the output voltage drops until V_{FB} falls below 50% of V_{REF} . The device considers this an output dead short, and triggers hiccup short-circuit protection (SCP) mode to periodically restart the part.

In hiccup mode, the MPQ4572 disables its output power stage, slowly discharges the soft-start capacitor, and then initiates a soft start. If the short-circuit condition remains after soft start ends, the device repeats this operation until the short circuit disappears and the output returns to the regulation level. This protection mode greatly reduces the average short-circuit current to alleviate thermal issues and protect the regulator.

Negative Current Protection

The MPQ4572 has a -1.3A negative current limit. Once the inductor current reaches the current limit, the LS-FET immediately turns off and the HS-FET turns on. The current limit prevents the negative current from dropping too low and damaging the components.

Thermal Shutdown

For thermal protection, the MPQ4572 monitors the IC temperature internally. This function prevents the chip from operating at exceedingly high temperatures. If the junction temperature exceeds the threshold value (about 170°C), it shuts down the whole chip. This is a non-latch protection. There is a 25°C hysteresis. Once the junction temperature drops to about 145°C, the device resumes operation by initiating a soft start.

Floating Driver and Bootstrap Charging

An external bootstrap capacitor powers the floating HS-FET driver. There are two methods to charge the bootstrap capacitor (see Figure 3).

The first method is through the main charging circuit from V_{CC} through a diode. When the HS-FET is on, V_{SW} is about equal to V_{IN} but exceeds V_{CC} , and the bootstrap capacitor is not charged. The best charging period occurs when the LS-FET is on, and $V_{CC} - V_{SW}$ is at its largest. When there is no current in the inductor, V_{SW} equals V_{OUT} , so V_{CC} can only charge BST when V_{OUT} is very small.

The second method is through the auxiliary charging circuit from V_{IN} . When the voltage difference between BST and SW is below the internal 5V bootstrap regulator, a PMOS pass transistor (M1) turns on to charge the bootstrap capacitor. The charging current is much smaller than that from V_{CC} , but as long as V_{IN} exceeds V_{SW} , BST can be charged. This function is useful in sleep mode, when there is not always a switch.

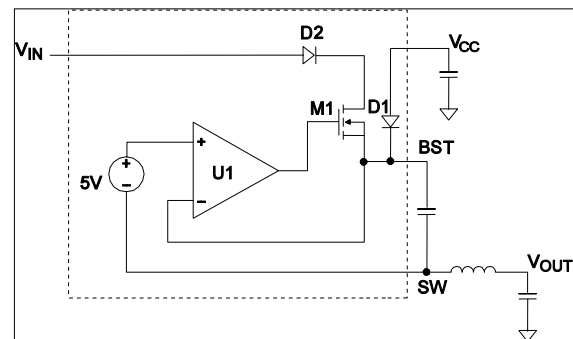

Figure 3: Internal Bootstrap Charging Circuit

Low-Dropout Operation (BST Refresh)

To improve dropout, the MPQ4572 is designed to operate at close to 100% duty cycle as long as the BST-to-SW voltage exceeds 1.4V. When the BST-to-SW voltage drops below 1.34V, the HS-FET turns off using a UVLO circuit, which allows the LS-FET to conduct and refresh the charge on the BST capacitor. When the input voltage drops, the HS-FET remains on and close to 100% duty cycle to maintain output regulation, until the BST-to-SW voltage falls below 1.34V.

Since the supply current sourced from the BST capacitor is low, the HS-FET can remain on for more switching cycles than are required to refresh the capacitor. This means the effective duty cycle of the switching regulator is high.

The effective duty cycle during regulator dropout is mostly influenced by the voltage drops across the power MOSFET, inductor resistance, low-side diode, and PCB resistance.

Start-Up and Shutdown

If both V_{IN} and V_{EN} exceed their respective thresholds, the chip starts. The reference block starts first, generating a stable reference voltage and current, and then the internal regulator is enabled. The regulator provides a stable supply for the remaining circuitries.

While the internal supply rail is up, an internal timer holds the power MOSFET off for about 50 μ s to blank the start-up glitches. When the soft-start block is enabled, it first holds its SS output low to ensure the circuitries are ready, and then slowly ramps up.

Three events can shut down the chip: EN going low, V_{IN} UVLO, and thermal shutdown. In the shutdown procedure, the signaling path is first blocked to avoid any fault triggering. The COMP voltage and the internal supply rail are then pulled down. The floating driver is not subject to this shutdown command, but its charging path is disabled.

APPLICATION INFORMATION

Setting the Output Voltage

The external resistor divider connected to the FB pin sets the output voltage (see the Typical Application section on page 29). The feedback resistor (R1) must account for both stability and dynamic response, so it cannot be too large or too small. Choose an R1 value of about 40kΩ. R2 is then estimated with Equation (2):

$$R2 = \frac{R1}{\frac{V_{OUT}}{0.8} - 1} \quad (2)$$

Figure 4 shows the recommended T-type feedback network.

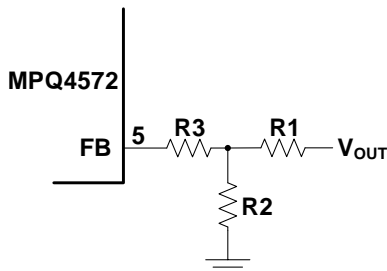

Figure 4: Feedback Network

R3 + R1 is used to set the loop bandwidth. A higher R3 + R1 indicates a lower bandwidth. To ensure loop stability, it is strongly recommended to limit the bandwidth below 1/10 of the switching frequency, and no higher than 100kHz.

The calculated resistance may need fine-tuning via bench testing. Table 1 lists the recommended feedback divider resistor values for common output voltages. Use check loop analysis before using the device in an application, and change the resistance of R3 for loop stability if necessary.

Table 1: Resistor Values for Typical V_{OUT}

V _{OUT} (V)	R1 (kΩ)	R2 (kΩ)
3.3	41.2	13
5.0	41.2	7.68

Selecting the Inductor

The inductor must supply constant current to the output load while being driven by the switching input voltage. For the highest efficiency, choose an inductor with a low DC resistance. High inductance will result in less ripple current and lower output ripple voltage. However, a larger inductance value results in a physically larger

inductor, higher series resistance, and lower saturation current.

A good rule to determine the ideal inductance value is to allow the inductor ripple current to be approximately 30% of the maximum load current. Ensure that the peak inductor current is below the device peak current limit. The inductance value can be calculated with Equation (3):

$$L = \frac{V_{OUT}}{f_{SW} \times \Delta I_L} \times \left(1 - \frac{V_{OUT}}{V_{IN}}\right) \quad (3)$$

Where ΔI_L is the peak-to-peak inductor ripple current.

Choose an inductor that will not saturate under the maximum inductor peak current. Calculate the peak inductor current with Equation (4):

$$I_{LP} = I_{OUT} + \frac{V_{OUT}}{2f_{SW} \times L} \times \left(1 - \frac{V_{OUT}}{V_{IN}}\right) \quad (4)$$

Selecting the Input Capacitor

The step-down converter has a discontinuous input current, and requires a capacitor to supply the AC current to the converter while maintaining the DC input voltage. Use low-ESR capacitors for the best performance. Ceramic capacitors with X5R or X7R dielectrics are strongly recommended because of their low ESR and small temperature coefficients. Other capacitors, such as Y5V and Z5U, should not be used since they lose too much capacitance with frequency, temperature, and bias voltage.

Place the input capacitors as close to the IN pin as possible. For most applications, a 22μF capacitor is sufficient. For higher output voltages, use a 47μF capacitor to improve system stability. To maintain a small solution size, choose a properly sized capacitor that has a voltage rating compliant with the input spec.

Since the input capacitor absorbs the input switching current, it requires an adequate ripple current rating, which should not exceed the converter's maximum input ripple current. The input ripple current can be estimated with Equation (5):

$$I_{CIN} = I_{OUT} \times \sqrt{\frac{V_{OUT}}{V_{IN}} \times \left(1 - \frac{V_{OUT}}{V_{IN}}\right)} \quad (5)$$

The worst-case condition occurs at $V_{IN} = 2V_{OUT}$, calculated with Equation (6):

$$I_{CIN} = \frac{I_{OUT}}{2} \quad (6)$$

For simplification, choose an input capacitor with an RMS current rating greater than half of the maximum load current.

The input capacitor can be electrolytic, tantalum, or ceramic. When using electrolytic or tantalum capacitors, use a small, high-quality ceramic capacitor (0.1 μ F), placed as close to the IC as possible. The input capacitance value determines the input voltage ripple of the converter. If there is an input voltage ripple requirement in the system design, choose an input capacitor that meets the specification.

The input voltage ripple caused by the capacitance can be estimated with Equation (7):

$$\Delta V_{IN} = \frac{I_{OUT}}{f_{SW} \times C_{IN}} \times \frac{V_{OUT}}{V_{IN}} \times \left(1 - \frac{V_{OUT}}{V_{IN}}\right) \quad (7)$$

The worst-case condition occurs at $V_{IN} = 2V_{OUT}$, estimated with Equation (8):

$$\Delta V_{IN} = \frac{1}{4} \times \frac{I_{OUT}}{f_{SW} \times C_{IN}} \quad (8)$$

Selecting the Output Capacitor

The output capacitor maintains the output DC voltage. Ceramic capacitors with low ESR are recommended for a small size and low output voltage ripple. Electrolytic and polymer capacitors may also be used. The output voltage ripple can be estimated with Equation (9):

$$\Delta V_{OUT} = \frac{V_{OUT}}{f_{SW} \times L} \times \left(1 - \frac{V_{OUT}}{V_{IN}}\right) \times \left(R_{ESR} + \frac{1}{8f_{SW} \times C_{OUT}}\right) \quad (9)$$

Where R_{ESR} is the equivalent series resistance of the output capacitor.

For ceramic capacitors, the capacitance dominates the impedance at the switching frequency and causes most of the output voltage ripple. For simplification, the output voltage ripple can be calculated with Equation (10):

$$\Delta V_{OUT} = \frac{V_{OUT}}{8 \times f_{SW}^2 \times L \times C_{OUT}} \times \left(1 - \frac{V_{OUT}}{V_{IN}}\right) \quad (10)$$

For tantalum or electrolytic capacitors, the ESR dominates the impedance at the switching frequency. For simplification, the output ripple can be calculated with Equation (11):

$$\Delta V_{OUT} = \frac{V_{OUT}}{f_{SW} \times L} \times \left(1 - \frac{V_{OUT}}{V_{IN}}\right) \times R_{ESR} \quad (11)$$

Another consideration for output capacitance is the allowable overshoot in V_{OUT} if the load is suddenly removed. In this case, energy stored in the inductor is transferred to C_{OUT} , causing its voltage to rise. To achieve a desired overshoot relative to the regulated voltage, the output capacitance can be estimated with Equation (12):

$$C_{OUT} = \frac{I_{OUT}^2 \times L}{V_{OUT}^2 \times \left(\left(\frac{V_{OUTMAX}}{V_{OUT}}\right)^2 - 1\right)} \quad (12)$$

Where V_{OUTMAX} / V_{OUT} is the allowable maximum overshoot.

After calculating the capacitance required for both ripple and overshoot needs, choose the larger value.

The characteristics of the output capacitor also affect the stability of the regulation system. The MPQ4572 can be optimized for a wide range of capacitance and ESR values.

V_{IN} Under-Voltage Lockout (UVLO) Setting

The MPQ4572 has an internal, fixed UVLO threshold. The rising threshold is 4.0V, while the falling threshold is about 3.5V. For applications that require a higher UVLO point, place an external resistor divider between EN and IN to obtain a higher equivalent UVLO threshold (see Figure 5 and Figure 6). Add a 6V Zener diode between EN to GND if the EN pin is connected to V_{IN} through a resistor.

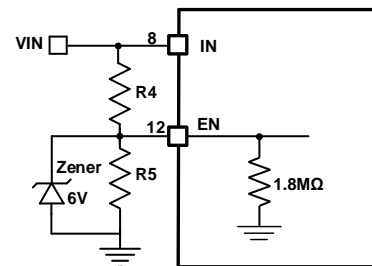

Figure 5: Adjustable UVLO Using EN Divider when EN Rises

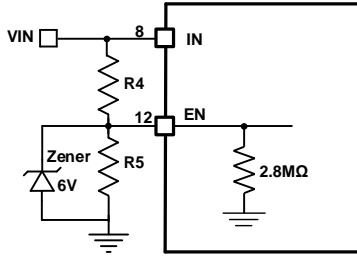

Figure 6: Adjustable UVLO Using EN Divider when EN Falling

The UVLO threshold can be calculated with Equation (13) and Equation (14) when EN is rising or falling, respectively:

$$INUV_{RISING} = \left(1 + \frac{R4}{1.8M/R5}\right) \times V_{EN_RISING} \quad (13)$$

$$INUV_{FALLING} = \left(1 + \frac{R4}{2.8M/R5}\right) \times V_{EN_FALLING} \quad (14)$$

Where $V_{EN_RISING} = 1.45V$, $V_{EN_FALLING} = 1.12V$.

When choosing R4, ensure it is big enough to limit the current flowing into EN pin below 100μA.

BST Resistor and Capacitor

A resistor in series with the BST capacitor (R_{BST}) can reduce the SW rising rate and voltage spikes. This enhances EMI performance and reduces voltage stress at a high V_{IN} . A higher resistance is better for SW spike reduction, but compromises efficiency. To make a tradeoff between EMI and efficiency, it is recommended to keep R_{BST} below 20Ω. The recommended BST capacitor value is between 0.1μF and 1μF.

PCB Layout Guidelines ⁽⁷⁾

An optimized PCB layout is very important for proper operation. A 4-layer layout is strongly recommended to improve thermal performance. For the best results, refer to Figure 7 and follow the guidelines below:

1. Place the high-current paths (GND, IN, and SW) very close to the device with short, direct, and wide traces.
2. Use large copper areas to minimize conduction loss and thermal stress.
3. Place the ceramic input capacitors as close to the IN and GND pins as possible to minimize high-frequency noise.
4. Place the T-type feedback resistors as close as possible to the FB pin to ensure that the trace connecting to the FB pin is as short as possible.
5. Route SW and BST away from sensitive analog areas, such as FB.
6. Use multiple vias to connect the power planes to internal layer.

Note:

- 7) The recommended PCB layout is based on the circuit in Figure 8.

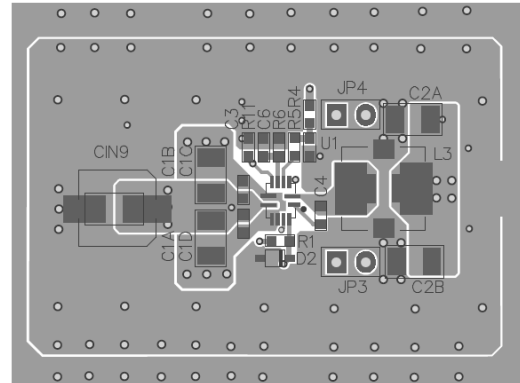

Top Layer and Top Silk

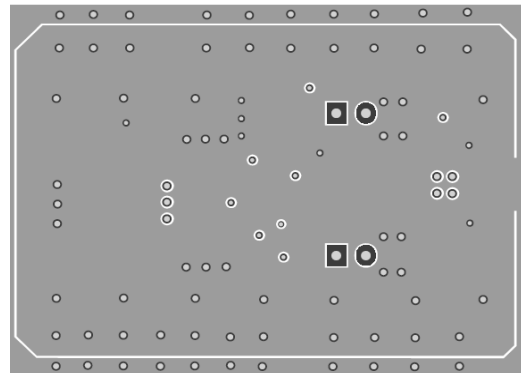

Inner Layer 1

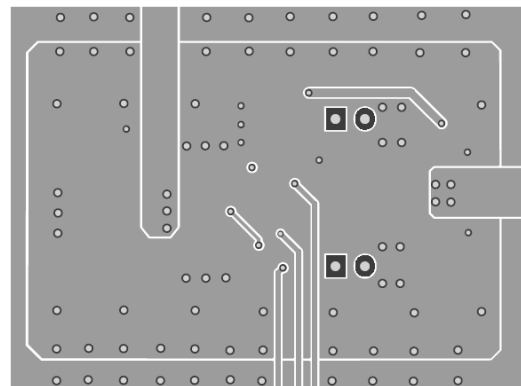

Inner Layer 2

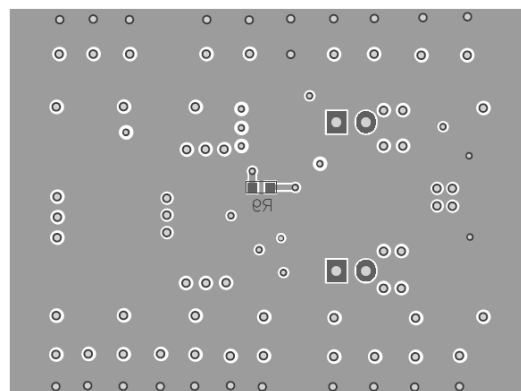

Bottom Layer and Bottom Silk

Figure 7: Recommended PCB Layout

TYPICAL APPLICATION CIRCUIT

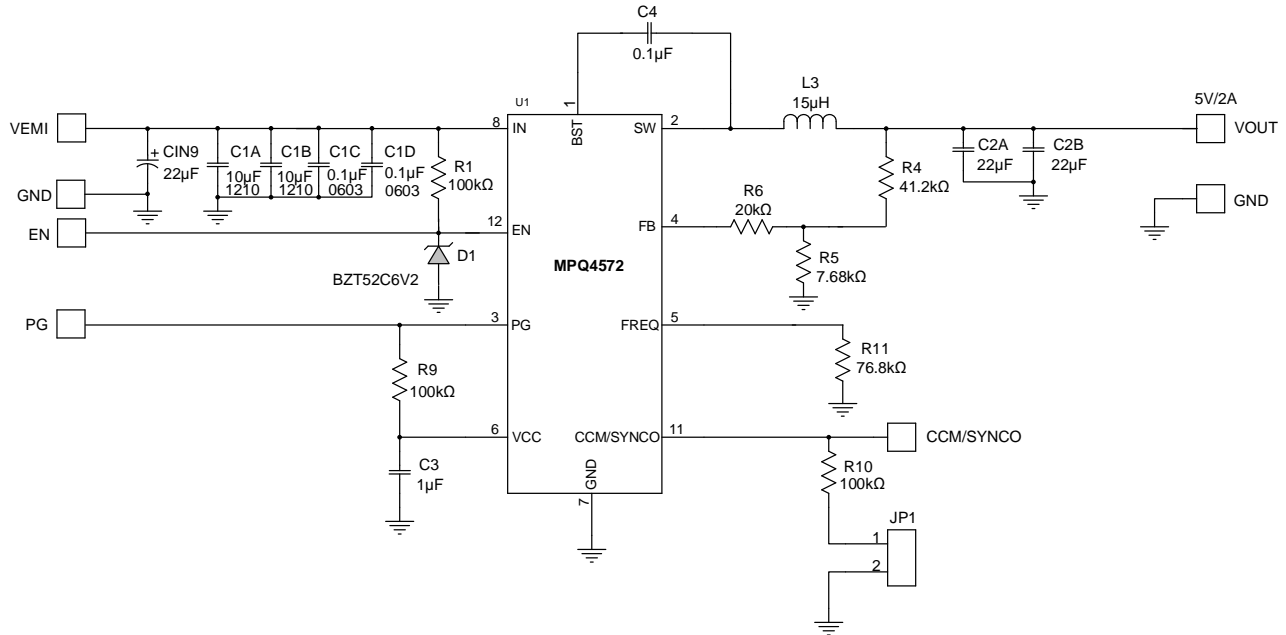

Figure 8: Typical Application Circuit

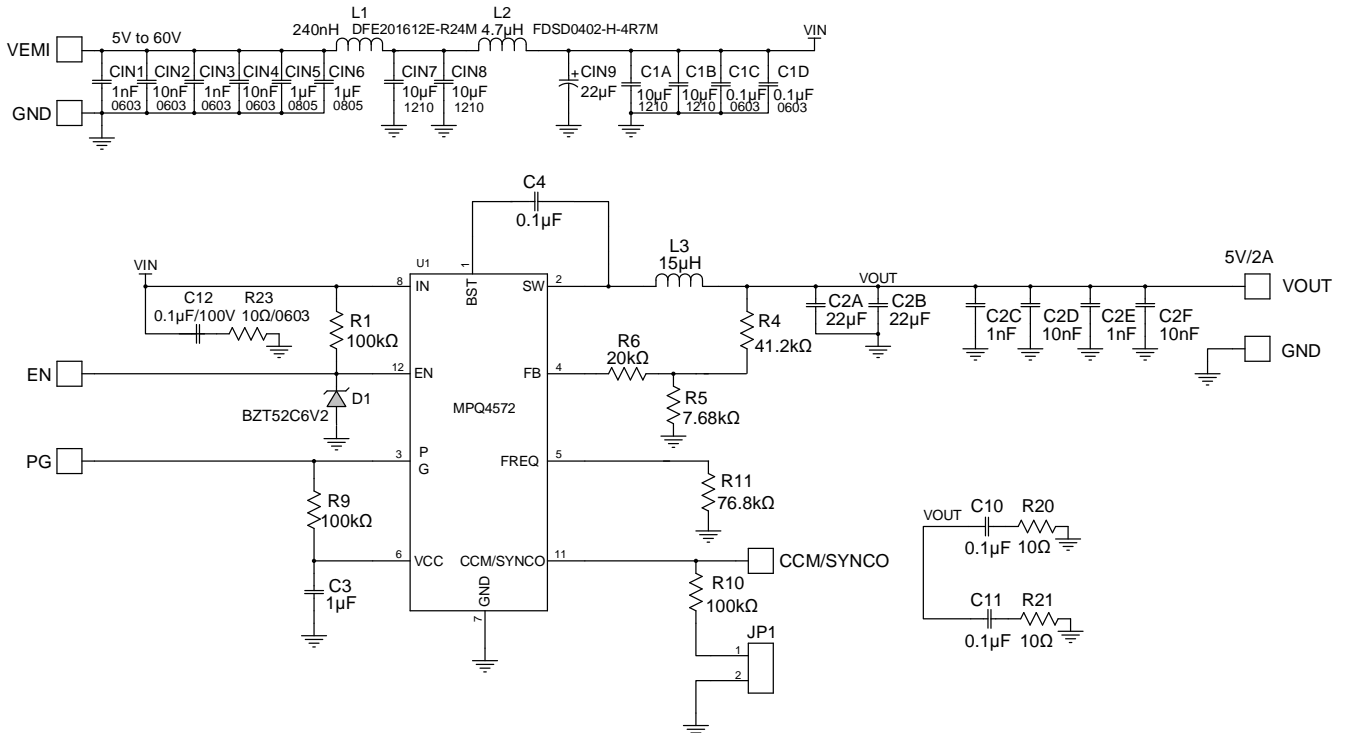
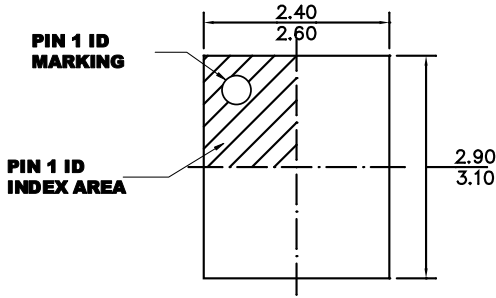

Figure 9: Typical Application Circuit with EMI Filters

PACKAGE INFORMATION

QFN-12 (2.5mmx3mm) Non-Wettable Flank



TOP VIEW

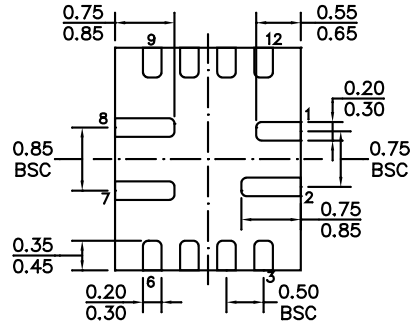

BOTTOM VIEW

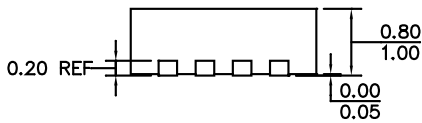

SIDE VIEW

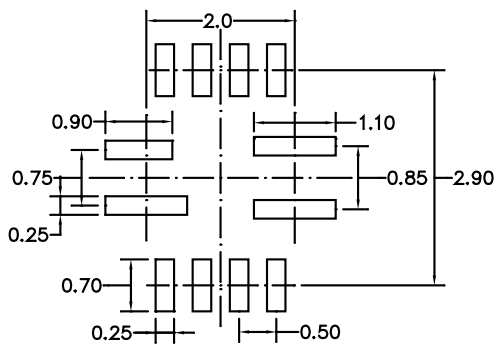

RECOMMENDED LAND PATTERN

NOTE:

- 1) LAND PATTERNS OF PINS 2, 7, AND 8 HAVE THE SAME LENGTH AND WIDTH.
- 2) ALL DIMENSIONS ARE IN MILLIMETERS.
- 3) LEAD COPLANARITY SHALL BE 0.10 MILLIMETERS MAX.
- 4) JEDEC REFERENCE IS MO-220.
- 5) DRAWING IS NOT TO SCALE.

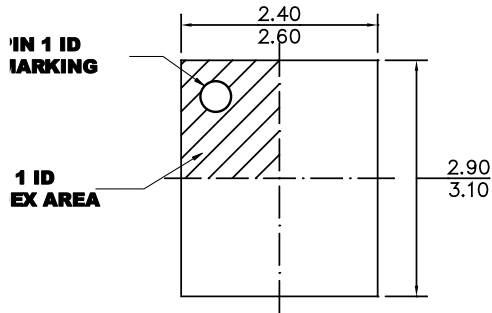
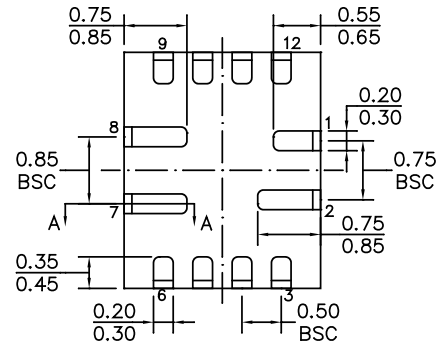
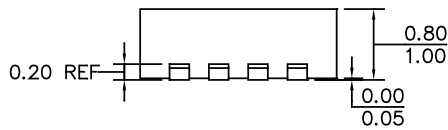
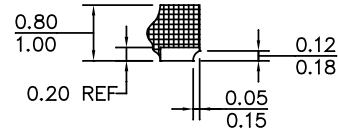
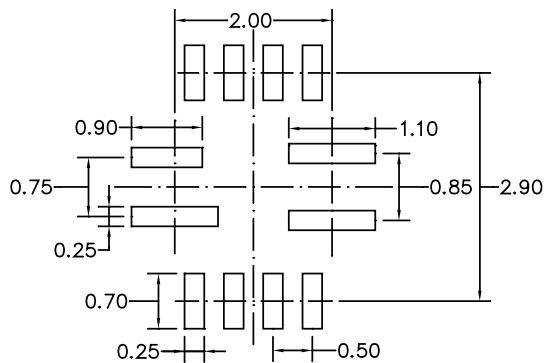
PACKAGE INFORMATION (continued)
**QFN-12 (2.5mmx3mm)
Wettable Flank**

TOP VIEW

BOTTOM VIEW

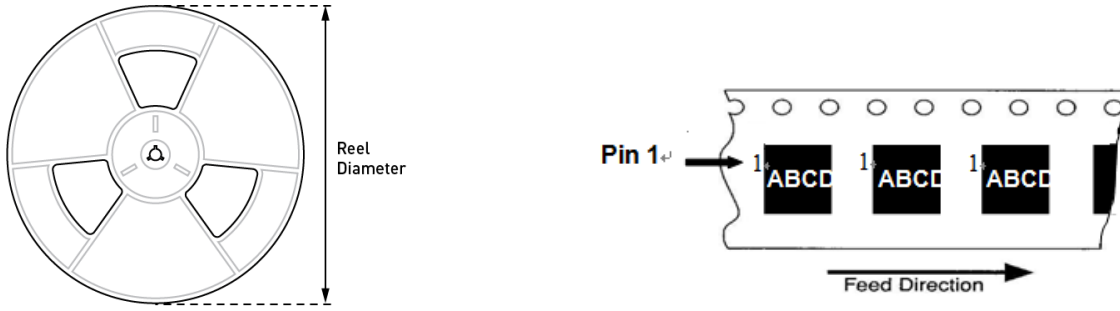
SIDE VIEW

SECTION A-A

RECOMMENDED LAND PATTERN
NOTE:

- 1) THE LEAD SIDE IS WETTABLE.
- 2) LAND PATTERNS OF PINS 2, 7, AND 8 HAVE THE SAME LENGTH AND WIDTH.
- 3) ALL DIMENSIONS ARE IN MILLIMETERS.
- 4) LEAD COPLANARITY SHALL BE 0.08 MILLIMETERS MAX.
- 5) JEDEC REFERENCE IS MO-220.
- 6) DRAWING IS NOT TO SCALE.

CARRIER INFORMATION



Part Number	Package Description	Quantity/Reel	Reel Diameter	Carrier Tape Width	Carrier Tape Pitch
MPQ4572GQB-Z	QFN-12 (2.5mmx3mm)	5000	13in	12mm	8mm
MPQ4572GQB-AEC1-Z					
MPQ4572GQBE-AEC1-Z					

Notice: The information in this document is subject to change without notice. Please contact MPS for current specifications. Users should warrant and guarantee that third-party Intellectual Property rights are not infringed upon when integrating MPS products into any application. MPS will not assume any legal responsibility for any said applications.