

RECOMMENDED PCB LAYOUT: COMPONENT SIDE

NOTES:

- MATERIAL:  
HSG: NYLON, GLASS-FILLED, UL94V-0, COLOR: BLACK  
CAP: NYLON, GLASS-FILLED, UL94V-0, COLOR: BLACK  
PIN: 0.64MM SQ, COPPER ALLOY
- PLATING TYPE:  
(1) GOLD FLASH OVER  
1.25µm MIN. NICKEL OVERALL.  
(2) GOLD FLASH ON CONTACT AND  
2.50µm MIN. TIN ON SOLDER TAIL OVER  
1.25µm MIN. NICKEL OVERALL.  
(4) 0.38µm MIN. GOLD PLATE ON CONTACT AND  
2.00µm MIN. TIN ON SOLDER TAIL OVER  
1.25µm MIN. NICKEL OVERALL.  
(5) 0.75µm MIN. GOLD PLATE ON CONTACT AND  
2.00µm MIN. TIN ON SOLDER TAIL OVER  
1.25µm MIN. NICKEL OVERALL.  
(6) 2.50µm MIN. TIN OVERALL  
1.25µm MIN. NICKEL OVERALL
- PRODUCT SPECIFICATION: PS-87920-019
- PACKAGING TYPE: SEE TABLE
- PACKAGING SPEC:  
TUBE WITH CAP VERSION: PK-89990-558  
TUBE W/O CAP VERSION: PK-89990-545  
TRAY W/O CAP: PK-89990-489  
EMBOSS TAPE WITH CAP: PK-89990-486 AND PK-87898-400
- WAFER TO BE FLAT WITHIN 0.003 mm/mm
- BEND DEPRESSION IS ACCEPTED SO LONG AS IT DOES NOT AFFECT THE OVERALL COPLANARITY OF TAIL
- COPLANARITY IS TO BE MEASURED BY RESTING THE SOLDER TAIL ON A FLAT SURFACE
- IRREGULAR CIRCUIT CUTOFF WITHIN BREAKAWAY SECTION IS PERMISSIBLE. CUTTING OR CHIPPING OF THE MAIN BODY IS NOT ACCEPTABLE
- CAP LOCATION IS CENTERED ALONG THE MATING ENDS AS SHOWN. TOP SURFACE OF CAP TO BE FLAT FOR THE PURPOSE OF PICK & PLACE BY VACUUM SUCTION NOZZLE
- RECOMMENDED PCB THICKNESS IS 1.60mm±0.10
- THE ABOVE CKT 6 IS FOR ILLUSTRATION PURPOSE ONLY
- TUBE LENGTH AS PER STANDARD 560mm

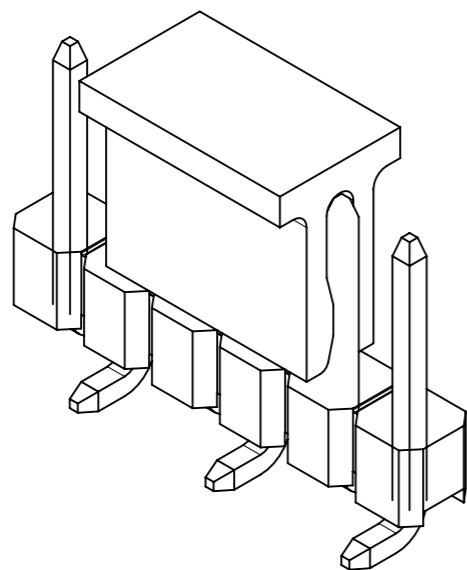
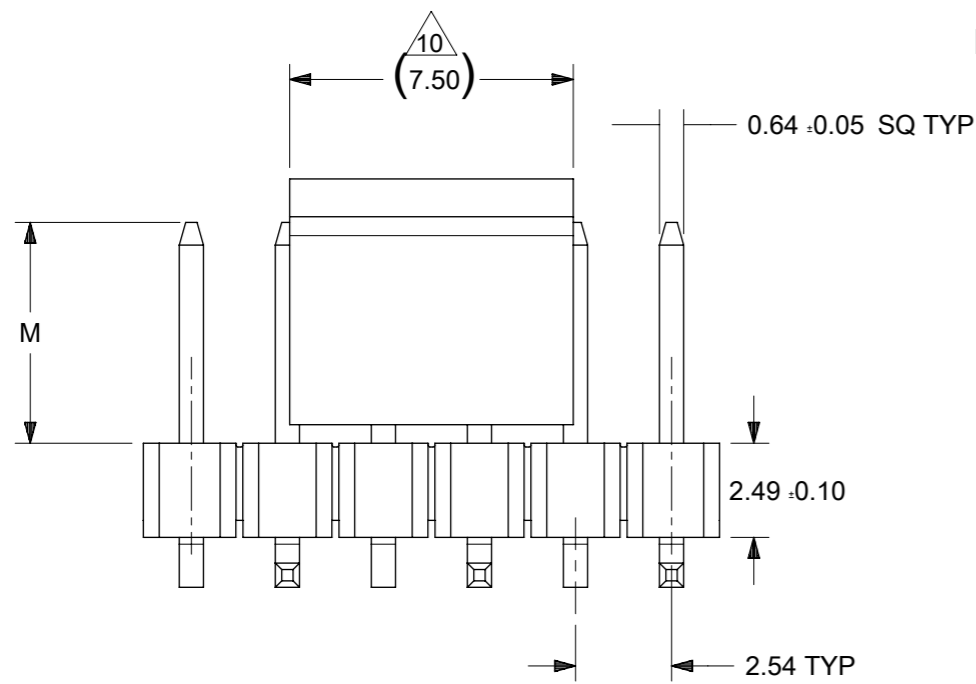

THIS DRAWING CONTAINS INFORMATION THAT IS PROPRIETARY TO MOLEX ELECTRONIC TECHNOLOGIES, LLC AND SHOULD NOT BE USED WITHOUT WRITTEN PERMISSION									
DIMENSION UNITS		SCALE		CURRENT REV DESC: BRIGHT TIN PHASE OUT					
mm		NTS							
GENERAL TOLERANCES (UNLESS SPECIFIED)									
		MM	INCH	<b>CUSTOM HEADER</b> 2.54MM PITCH SINGLE ROW SINGLE WAFER SMT HEADER  <b>PRODUCT CUSTOMER DRAWING</b>					
4 PLACES	±								
3 PLACES	±								
2 PLACES	±	0.2							
1 PLACE	±								
0 PLACES	±			EC NO: 679909		2021/06/29		DOCUMENT NUMBER	
ANGULAR TOL		± 3.0°		DRWN: AKUMAR19		2021/10/11		SD-87898-001	
DRAFT WHERE APPLICABLE MUST REMAIN WITHIN DIMENSIONS		THIRD ANGLE PROJECTION		CHK'D: MRAMAKRISHNA		2021/10/11		DOC TYPE	
				APPR: MRAMAKRISHNA		2021/10/11		DOC PART	
				INITIAL REVISION:				REVISION	
				DRWN: GGUNAGI		2016/11/09		PSD	
				APPR: ISHWARG		2016/12/06		000	
				DRAWING		SERIES		B24	
				A3-SIZE		87898		1 OF 21	
				MATERIAL NUMBER		CUSTOMER			
				SEE TABLE		GENERAL MARKET			

PACKAGING OPTION PART NO.						CKT SIZE	VOID POSITION	PLATING TYPE	DIMENSION				
TRAY WITHOUT CAP	TRAY WITH CAP	TUBE WITHOUT CAP	TUBE WITH CAP	TAPE & REEL WITHOUT CAP	TAPE & REEL WITH CAP				A	B	G	F	M
87898-0301	-----	-----	-----	-----	-----	3	----	1	7.62	5.08	10.81	9.65	5.84
87898-0302	-----	-----	-----	-----	-----	3	----	2	7.62	5.08	10.81	9.65	5.84
87898-0304	-----	-----	-----	-----	87898-0314	3	----	4	7.62	5.08	10.81	9.65	5.84
87898-0305	-----	-----	-----	-----	87898-0315	3	----	5	7.62	5.08	10.81	9.65	5.84
87898-0306	-----	-----	-----	-----	87898-0316	3	----	6	7.62	5.08	10.81	9.65	5.84
87898-0307	-----	-----	-----	-----	87898-0320	3	----	6	7.62	5.08	10.81	9.65	5.84
-----	-----	-----	-----	-----	87898-0317	3	-----	6	7.62	5.08	10.81	9.65	5.84
-----	-----	-----	-----	-----	87898-0321	3	-----	6	7.62	5.08	10.81	9.65	5.84
-----	-----	-----	-----	-----	87898-0318	3	----	5	7.62	5.08	10.81	9.65	5.84
-----	-----	-----	-----	-----	87898-0310	3	-----	6	7.62	5.08	14.91	13.91	10.10
-----	-----	-----	-----	-----	87898-0309	3	-----	6	7.62	5.08	14.81	13.81	10.00
-----	-----	87898-0370	-----	-----	-----	3	-----	6	7.62	5.08	----	13.91	10.10

REFER TO LAST SHEET FOR 2CKT SIZE

(B24)

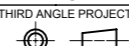
THIS DRAWING CONTAINS INFORMATION THAT IS PROPRIETARY TO MOLEX ELECTRONIC TECHNOLOGIES, LLC AND SHOULD NOT BE USED WITHOUT WRITTEN PERMISSION											
DIMENSION UNITS		SCALE		CURRENT REV DESC: BRIGHT TIN PHASE OUT							
mm		NTS									
GENERAL TOLERANCES (UNLESS SPECIFIED)				EC NO: 679909 DRWN: AKUMAR19 2021/06/29 CHK'D: MRAMAKRISHNA 2021/10/11 APPR: MRAMAKRISHNA 2021/10/11		CUSTOM HEADER					
						2.54MM PITCH SINGLE ROW SINGLE WAFER SMT HEADER					
						PRODUCT CUSTOMER DRAWING					
						DOCUMENT NUMBER		DOC TYPE		DOC PART	
						SD-87898-001		PSD		000 B24	
				INITIAL REVISION:		SERIES		SHEET NUMBER			
				DRWN: GGUNAGI 2016/11/09		87898		2 OF 21			
				APPR: ISHWARG 2016/12/06		MATERIAL NUMBER		CUSTOMER			
				ANGULAR TOL ± 3.0°		SEE TABLE		GENERAL MARKET			
DRAFT WHERE APPLICABLE MUST REMAIN WITHIN DIMENSIONS				THIRD ANGLE PROJECTION		DRAWING		SHEET NUMBER			
						A3-SIZE		2 OF 21			

DOCUMENT STATUS	P1	RELEASE DATE	2021/10/11	11:53:29
-----------------	----	--------------	------------	----------

10		9		8		7		6		5		4		3		2		1	
PACKAGING OPTION PART NO.																			
TRAY WITHOUT CAP	TRAY WITH CAP	TUBE WITHOUT CAP	TUBE WITH CAP	TAPE & REEL WITHOUT CAP	TAPE & REEL WITH CAP	CKT SIZE	VOID POSITION	PLATING TYPE	MODIFIED MATING CKT	MODIFIED MATING LENGTH	DIMENSION								
											A	B	G	F	M				
-----	-----	87898-0421	87898-0431	-----	87898-0451	4	-----	1	-----	-----	10.16	7.62	10.81	9.65	5.84				
-----	-----	87898-0422	87898-0432	-----	87898-0452	4	-----	2	-----	-----	10.16	7.62	10.81	9.65	5.84				
-----	-----	87898-0424	87898-0434	-----	87898-0454	4	-----	4	-----	-----	10.16	7.62	10.81	9.65	5.84				
-----	-----	87898-0425	87898-0435	-----	87898-0455	4	-----	5	-----	-----	10.16	7.62	10.81	9.65	5.84				
-----	-----	87898-0426	87898-0436	-----	87898-0456	4	-----	6	-----	-----	10.16	7.62	10.81	9.65	5.84				
-----	-----	87898-0428	87898-0437	-----	87898-0460	4	-----	6	-----	-----	10.16	7.62	10.81	9.65	5.84	B24			
-----	-----	-----	-----	-----	87898-0457	4	-----	6	-----	-----	10.16	7.62	10.81	9.65	5.84				
-----	-----	-----	-----	-----	87898-0458	4	-----	5	-----	-----	10.16	7.62	10.81	9.65	5.84				
-----	-----	-----	-----	-----	87898 - 0480	4	CKT# 4	5	-----	-----	10.16	7.62	14.70	13.65	9.84				
-----	-----	-----	-----	-----	87898 - 0481	4	-----	5	CKT # 1, 2 & 3	1.00	10.16	7.62	17.70	16.65	12.84				
87898 - 0482	-----	-----	-----	-----	-----	4	-----	---	CKT # 1, 2 & 3	1.00	10.16	7.62	---	16.65	12.84				
-----	-----	-----	-----	-----	87898 - 0483	4	-----	---	CKT # 1, 2 & 3	1.00	10.16	7.62	14.70	13.65	9.84				
-----	-----	87898-0427	-----	-----	-----	4	-----	---	-----	-----	10.16	7.62	---	11.87	8.06				
-----	-----	87898-0521	87898-0531	-----	87898-0551	5	-----	1	-----	-----	12.70	10.16	10.81	9.65	5.84				
-----	-----	87898-0522	87898-0532	-----	87898-0552	5	-----	2	-----	-----	12.70	10.16	10.81	9.65	5.84				
-----	-----	87898-0524	87898-0534	-----	87898-0554	5	-----	4	-----	-----	12.70	10.16	10.81	9.65	5.84				
-----	-----	87898-0525	87898-0535	-----	87898-0555	5	-----	5	-----	-----	12.70	10.16	10.81	9.65	5.84				
-----	-----	87898-0526	87898-0536	87898-0583	87898-0556	5	-----	6	-----	-----	12.70	10.16	10.81	9.65	5.84				
-----	-----	87898-0528	87898-0538	87898-0584	87898-0558	5	-----	6	-----	-----	12.70	10.16	10.81	9.65	5.84	B24			
87898-0581	-----	-----	-----	-----	-----	5	-----	4	-----	-----	12.70	10.16	---	24.18	20.25				
-----	-----	-----	-----	-----	87898-0576	5	-----	5	-----	-----	12.70	10.16	14.35	13.31	9.50				
-----	-----	87898-0621	87898-0631	-----	87898-0651	6	-----	1	-----	-----	15.24	12.70	10.81	9.65	5.84				
-----	-----	87898-0622	87898-0632	-----	87898-0652	6	-----	2	-----	-----	15.24	12.70	10.81	9.65	5.84				
-----	-----	87898-0624	87898-0634	-----	87898-0654	6	-----	4	-----	-----	15.24	12.70	10.81	9.65	5.84				
-----	-----	87898-0625	87898-0635	-----	87898-0655	6	-----	5	-----	-----	15.24	12.70	10.81	9.65	5.84				
-----	-----	87898-0626	87898-0636	-----	87898-0656	6	-----	6	-----	-----	15.24	12.70	10.81	9.65	5.84				
-----	-----	87898-0628	87898-0638	-----	87898-0658	6	-----	6	-----	-----	15.24	12.70	10.81	9.65	5.84	B24			
87898-0607	-----	-----	-----	-----	87898-0657	6	-----	6	-----	-----	15.24	12.70	16.47	15.31	11.50				
-----	-----	-----	-----	-----	87898-0605	6	-----	5	-----	-----	15.24	12.70	12.98	11.94	8.13				
-----	-----	87898-0604	-----	-----	-----	6	-----	5	-----	-----	15.24	12.70	---	13.31	9.50				

THIS DRAWING CONTAINS INFORMATION THAT IS PROPRIETARY TO MOLEX ELECTRONIC TECHNOLOGIES, LLC AND SHOULD NOT BE USED WITHOUT WRITTEN PERMISSION

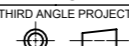
DIMENSION UNITS	SCALE	CURRENT REV DESC: BRIGHT TIN PHASE OUT	
mm	NTS	 CUSTOM HEADER 2.54MM PITCH SINGLE ROW SINGLE WAFER SMT HEADER	
GENERAL TOLERANCES (UNLESS SPECIFIED)			
	MM	INCH	EC NO: 679909 DRWN: AKUMAR19 2021/06/29 CHK'D: MRAMAKRISHNA 2021/10/11 APPR: MRAMAKRISHNA 2021/10/11 INITIAL REVISION: DRWN: GGUNAGI 2016/11/09 APPR: ISHWARG 2016/12/06
4 PLACES	±	±	
3 PLACES	±	±	
2 PLACES	± 0.2	±	
1 PLACE	±	±	
0 PLACES	±	±	DOCUMENT NUMBER <b>SD-87898-001</b>
ANGULAR TOL	± 3.0°		DOC TYPE PSD
DRAFT WHERE APPLICABLE MUST REMAIN WITHIN DIMENSIONS		THIRD ANGLE PROJECTION 	DRAWING <b>A3-SIZE</b>
		SERIES <b>87898</b>	DOC PART <b>000</b>
		MATERIAL NUMBER SEE TABLE	CUSTOMER GENERAL MARKET
		SHEET NUMBER <b>3 OF 21</b>	REVISION <b>B24</b>

PACKAGING OPTION PART NO.						CKT SIZE	VOID POSITION	PLATING TYPE	DIMENSION				
TRAY WITHOUT CAP	TRAY WITH CAP	TUBE WITHOUT CAP	TUBE WITH CAP	TAPE & REEL WITHOUT CAP	TAPE & REEL WITH CAP				A	B	G	F	M
-----	-----	87898-0721	87898-0731	-----	87898-0751	7	----	1	17.78	15.24	10.81	9.65	5.84
-----	-----	87898-0722	87898-0732	-----	87898-0752	7	----	2	17.78	15.24	10.81	9.65	5.84
-----	-----	87898-0724	87898-0734	-----	87898-0754	7	----	4	17.78	15.24	10.81	9.65	5.84
-----	-----	87898-0725	87898-0735	-----	87898-0755	7	----	5	17.78	15.24	10.81	9.65	5.84
-----	-----	87898-0726	87898-0736	-----	87898-0756	7	----	6	17.78	15.24	10.81	9.65	5.84
-----	-----	87898-0727	87898-0737	-----	87898-0758	7	----	6	17.78	15.24	10.81	9.65	5.84
-----	-----	-----	-----	B22 87898-0757	-----	7	----	6	17.78	15.24	---	9.65	5.84
-----	-----	-----	-----	87898-0759	-----	7	----	6	17.78	15.24	---	9.65	5.84
-----	-----	87898-0720	-----	-----	-----	7	----	5	17.78	15.24	---	9.81	6.00
-----	-----	87898-0767	-----	-----	-----	7	----	5	17.78	15.24	---	13.81	10.00
-----	-----	87898-0821	87898-0831	-----	87898-0851	8	----	1	20.32	17.78	10.81	9.65	5.84
-----	-----	87898-0822	87898-0832	-----	87898-0852	8	----	2	20.32	17.78	10.81	9.65	5.84
-----	-----	87898-0824	87898-0834	-----	87898-0854	8	----	4	20.32	17.78	10.81	9.65	5.84
-----	-----	87898-0825	87898-0835	-----	87898-0855	8	----	5	20.32	17.78	10.81	9.65	5.84
-----	-----	87898-0826	87898-0836	-----	87898-0856	8	----	6	20.32	17.78	10.81	9.65	5.84
-----	-----	87898-0827	87898-0837	-----	87898-0857	8	----	6	20.32	17.78	10.81	9.65	5.84
87898-0881	-----	-----	-----	-----	-----	8	----	4	20.32	17.78	---	21.84	17.91
-----	-----	87898-0921	87898-0931	-----	87898-0951	9	----	1	22.86	20.32	10.81	9.65	5.84
-----	-----	87898-0922	87898-0932	-----	87898-0952	9	----	2	22.86	20.32	10.81	9.65	5.84
-----	-----	87898-0924	87898-0934	-----	87898-0954	9	----	4	22.86	20.32	10.81	9.65	5.84
-----	-----	87898-0925	87898-0935	-----	87898-0955	9	----	5	22.86	20.32	10.81	9.65	5.84
-----	-----	87898-0926	87898-0936	-----	87898-0956	9	----	6	22.86	20.32	10.81	9.65	5.84

B24

B24

B24

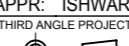
THIS DRAWING CONTAINS INFORMATION THAT IS PROPRIETARY TO MOLEX ELECTRONIC TECHNOLOGIES, LLC AND SHOULD NOT BE USED WITHOUT WRITTEN PERMISSION															
DIMENSION UNITS		SCALE		CURRENT REV DESC: BRIGHT TIN PHASE OUT											
mm		NTS		 CUSTOM HEADER 2.54MM PITCH SINGLE ROW SINGLE WAFER SMT HEADER											
GENERAL TOLERANCES (UNLESS SPECIFIED)															
		MM		INCH		EC NO: 679909 DRWN: AKUMAR19 2021/06/29 CHK'D: MRAMAKRISHNA 2021/10/11 APPR: MRAMAKRISHNA 2021/10/11 INITIAL REVISION: DRWN: GGUNAGI 2016/11/09 APPR: ISHWARG 2016/12/06									
4 PLACES	±		±							DOCUMENT NUMBER			DOC TYPE	DOC PART	REVISION
3 PLACES	±		±							SD-87898-001			PSD	000	B24
2 PLACES	±	0.2	±							PRODUCT CUSTOMER DRAWING					
1 PLACE	±		±							MATERIAL NUMBER			CUSTOMER		SHEET NUMBER
0 PLACES	±		±			SEE TABLE			GENERAL MARKET		4 OF 21				
ANGULAR TOL ± 3.0°				THIRD ANGLE PROJECTION		DRAWING		SERIES							
DRAFT WHERE APPLICABLE MUST REMAIN WITHIN DIMENSIONS						A3-SIZE		87898							

DOCUMENT STATUS	P1	RELEASE DATE	2021/10/11	11:53:29
-----------------	----	--------------	------------	----------

PACKAGING OPTION PART NO.										DIMENSION				
TRAY WITHOUT CAP	TRAY WITH CAP	TUBE WITHOUT CAP	TUBE WITH CAP	TAPE & REEL WITHOUT CAP	TAPE & REEL WITH CAP	CKT SIZE	VOID POSITION	PLATING TYPE	A	B	G	F	M	
-----	-----	87898-1021	87898-1031	-----	87898-1051	10	-----	1	25.40	22.86	10.81	9.65	5.84	
-----	-----	87898-1022	87898-1032	-----	87898-1052	10	-----	2	25.40	22.86	10.81	9.65	5.84	
-----	-----	87898-1024	87898-1034	-----	87898-1054	10	-----	4	25.40	22.86	10.81	9.65	5.84	
-----	-----	87898-1025	87898-1035	-----	87898-1055	10	-----	5	25.40	22.86	10.81	9.65	5.84	
-----	-----	87898-1026	87898-1036	-----	87898-1056	10	-----	6	25.40	22.86	10.81	9.65	5.84	
-----	-----	87898-1027	87898-1037	-----	87898-1057	10	-----	6	25.40	22.86	10.81	9.65	5.84	
-----	-----	87898-1003	-----	-----	-----	10	-----	5	25.40	22.86	---	9.81	6.00	
-----	-----	87898-1121	87898-1131	-----	87898-1151	11	-----	1	27.94	25.40	10.81	9.65	5.84	
-----	-----	87898-1122	87898-1132	-----	87898-1152	11	-----	2	27.94	25.40	10.81	9.65	5.84	
-----	-----	87898-1124	87898-1134	-----	87898-1154	11	-----	4	27.94	25.40	10.81	9.65	5.84	
-----	-----	87898-1125	87898-1135	-----	87898-1155	11	-----	5	27.94	25.40	10.81	9.65	5.84	
-----	-----	87898-1126	87898-1136	-----	87898-1156	11	-----	6	27.94	25.40	10.81	9.65	5.84	
-----	-----	87898-1221	87898-1231	-----	87898-1251	12	-----	1	30.48	27.94	10.81	9.65	5.84	
-----	-----	87898-1222	87898-1232	-----	87898-1252	12	-----	2	30.48	27.94	10.81	9.65	5.84	
-----	-----	87898-1224	87898-1234	-----	87898-1254	12	-----	4	30.48	27.94	10.81	9.65	5.84	
-----	-----	87898-1225	87898-1235	-----	87898-1255	12	-----	5	30.48	27.94	10.81	9.65	5.84	
-----	-----	87898-1226	87898-1236	-----	87898-1256	12	-----	6	30.48	27.94	10.81	9.65	5.84	

(B24)

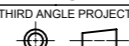
THIS DRAWING CONTAINS INFORMATION THAT IS PROPRIETARY TO MOLEX ELECTRONIC TECHNOLOGIES, LLC AND SHOULD NOT BE USED WITHOUT WRITTEN PERMISSION											
DIMENSION UNITS		SCALE		CURRENT REV DESC: BRIGHT TIN PHASE OUT							
mm		NTS									
GENERAL TOLERANCES (UNLESS SPECIFIED)				EC NO: 679909 DRWN: AKUMAR19 2021/06/29 CHK'D: MRAMAKRISHNA 2021/10/11 APPR: MRAMAKRISHNA 2021/10/11		CUSTOM HEADER					
						2.54MM PITCH SINGLE ROW SINGLE WAFER SMT HEADER					
						PRODUCT CUSTOMER DRAWING					
						DOCUMENT NUMBER		DOC TYPE		DOC PART	
						SD-87898-001		PSD		000 B24	
				INITIAL REVISION:		SERIES		SHEET NUMBER			
				DRWN: GGUNAGI 2016/11/09		87898		5 OF 21			
				APPR: ISHWARG 2016/12/06		MATERIAL NUMBER		CUSTOMER			
				ANGULAR TOL ± 3.0°		SEE TABLE		GENERAL MARKET			
DRAFT WHERE APPLICABLE MUST REMAIN WITHIN DIMENSIONS				THIRD ANGLE PROJECTION		DRAWING		SHEET NUMBER			
						A3-SIZE		5 OF 21			

DOCUMENT STATUS	P1	RELEASE DATE	2021/10/11	11:53:29
-----------------	----	--------------	------------	----------

PACKAGING OPTION PART NO.						CKT SIZE	VOID POSITION	PLATING TYPE	DIMENSION				
TRAY WITHOUT CAP	TRAY WITH CAP	TUBE WITHOUT CAP	TUBE WITH CAP	TAPE & REEL WITHOUT CAP	TAPE & REEL WITH CAP				A	B	G	F	M
-----	-----	87898-1321	87898-1331	-----	87898-1351	13	-----	1	33.02	30.48	10.81	9.65	5.84
-----	-----	87898-1322	87898-1332	-----	87898-1352	13	-----	2	33.02	30.48	10.81	9.65	5.84
-----	-----	87898-1324	87898-1334	-----	87898-1354	13	-----	4	33.02	30.48	10.81	9.65	5.84
-----	-----	87898-1325	87898-1335	-----	87898-1355	13	-----	5	33.02	30.48	10.81	9.65	5.84
-----	-----	87898-1326	87898-1336	-----	87898-1356	13	-----	6	33.02	30.48	10.81	9.65	5.84
-----	-----	87898-1421	87898-1431	-----	87898-1451	14	-----	1	35.56	33.02	10.81	9.65	5.84
-----	-----	87898-1422	87898-1432	-----	87898-1452	14	-----	2	35.56	33.02	10.81	9.65	5.84
-----	-----	87898-1424	87898-1434	-----	87898-1454	14	-----	4	35.56	33.02	10.81	9.65	5.84
-----	-----	87898-1425	87898-1435	-----	87898-1455	14	-----	5	35.56	33.02	10.81	9.65	5.84
-----	-----	87898-1426	87898-1436	-----	87898-1456	14	-----	6	35.56	33.02	10.81	9.65	5.84
-----	-----	87898-1427	87898-1437	-----	87898-1457	14	-----	6	35.56	33.02	10.81	9.65	5.84
-----	-----	87898-1521	87898-1531	-----	87898-1551	15	-----	1	38.10	35.56	10.81	9.65	5.84
-----	-----	87898-1522	87898-1532	-----	87898-1552	15	-----	2	38.10	35.56	10.81	9.65	5.84
-----	-----	87898-1524	87898-1534	-----	87898-1554	15	-----	4	38.10	35.56	10.81	9.65	5.84
-----	-----	87898-1525	87898-1535	-----	87898-1555	15	-----	5	38.10	35.56	10.81	9.65	5.84
-----	-----	87898-1526	87898-1536	-----	87898-1556	15	-----	6	38.10	35.56	10.81	9.65	5.84

(B24)

THIS DRAWING CONTAINS INFORMATION THAT IS PROPRIETARY TO MOLEX ELECTRONIC TECHNOLOGIES, LLC AND SHOULD NOT BE USED WITHOUT WRITTEN PERMISSION													
DIMENSION UNITS		SCALE		CURRENT REV DESC: BRIGHT TIN PHASE OUT									
mm		NTS		 <p>CUSTOM HEADER 2.54MM PITCH SINGLE ROW SINGLE WAFER SMT HEADER</p> <p>PRODUCT CUSTOMER DRAWING</p>									
GENERAL TOLERANCES (UNLESS SPECIFIED)													
		MM	INCH	EC NO: 679909 DRWN: AKUMAR19 2021/06/29 CHK'D: MRAMAKRISHNA 2021/10/11 APPR: MRAMAKRISHNA 2021/10/11 INITIAL REVISION: DRWN: GGUNAGI 2016/11/09 APPR: ISHWARG 2016/12/06									
4 PLACES	±	±	±										
3 PLACES	±	±	±										
2 PLACES	±	0.2	±										
1 PLACE	±	±	±										
0 PLACES	±	±	±	DOCUMENT NUMBER		DOC TYPE		DOC PART		REVISION			
ANGULAR TOL ± 3.0°				SD-87898-001		PSD		000		B24			
DRAFT WHERE APPLICABLE MUST REMAIN WITHIN DIMENSIONS				THIRD ANGLE PROJECTION		DRAWING		SERIES		MATERIAL NUMBER		CUSTOMER	
						A3-SIZE		87898		SEE TABLE		GENERAL MARKET	
										SHEET NUMBER		6 OF 21	

DOCUMENT STATUS	P1	RELEASE DATE	2021/10/11	11:53:29
-----------------	----	--------------	------------	----------

PACKAGING OPTION PART NO.										DIMENSION				
TRAY WITHOUT CAP	TRAY WITH CAP	TUBE WITHOUT CAP	TUBE WITH CAP	TAPE & REEL WITHOUT CAP	TAPE & REEL WITH CAP	CKT SIZE	VOID POSITION	PLATING TYPE	A	B	G	F	M	
-----	-----	87898-1621	87898-1631	-----	87898-1651	16	----	1	40.64	38.10	10.81	9.65	5.84	
-----	-----	87898-1622	87898-1632	-----	87898-1652	16	----	2	40.64	38.10	10.81	9.65	5.84	
-----	-----	87898-1624	87898-1634	-----	87898-1654	16	----	4	40.64	38.10	10.81	9.65	5.84	
-----	-----	87898-1625	87898-1635	-----	87898-1655	16	----	5	40.64	38.10	10.81	9.65	5.84	
-----	-----	87898-1626	87898-1636	-----	87898-1656	16	----	6	40.64	38.10	10.81	9.65	5.84	
-----	-----	87898-1627	87898-1637	-----	87898-1657	16	----	6	40.64	38.10	10.81	9.65	5.84	
-----	-----	87898-1721	87898-1731	-----	87898-1751	17	----	1	43.18	40.64	10.81	9.65	5.84	
-----	-----	87898-1722	87898-1732	-----	87898-1752	17	----	2	43.18	40.64	10.81	9.65	5.84	
-----	-----	87898-1724	87898-1734	-----	87898-1754	17	----	4	43.18	40.64	10.81	9.65	5.84	
-----	-----	87898-1725	87898-1735	-----	87898-1755	17	----	5	43.18	40.64	10.81	9.65	5.84	
-----	-----	87898-1726	87898-1736	-----	87898-1756	17	----	6	43.18	40.64	10.81	9.65	5.84	
-----	-----	87898-1821	87898-1831	-----	87898-1851	18	----	1	45.72	43.18	10.81	9.65	5.84	
-----	-----	87898-1822	87898-1832	-----	87898-1852	18	----	2	45.72	43.18	10.81	9.65	5.84	
-----	-----	87898-1824	87898-1834	-----	87898-1854	18	----	4	45.72	43.18	10.81	9.65	5.84	
-----	-----	87898-1825	87898-1835	-----	87898-1855	18	----	5	45.72	43.18	10.81	9.65	5.84	
-----	-----	87898-1826	87898-1836	-----	87898-1856	18	----	6	45.72	43.18	10.81	9.65	5.84	
-----	-----	87898-1827	87898-1837	-----	87898-1857	18	----	6	45.72	43.18	10.81	9.65	5.84	

(B24)

(B24)

THIS DRAWING CONTAINS INFORMATION THAT IS PROPRIETARY TO MOLEX ELECTRONIC TECHNOLOGIES, LLC AND SHOULD NOT BE USED WITHOUT WRITTEN PERMISSION									
DIMENSION UNITS		SCALE		CURRENT REV DESC: BRIGHT TIN PHASE OUT					
mm		NTS							
GENERAL TOLERANCES (UNLESS SPECIFIED)				EC NO: 679909		CUSTOMER		CUSTOMER	
				DRWN: AKUMAR19		2021/06/29		2.54MM PITCH SINGLE ROW SINGLE WAFER SMT HEADER	
				CHK'D: MRAMAKRISHNA		2021/10/11		PRODUCT CUSTOMER DRAWING	
				APPR: MRAMAKRISHNA		2021/10/11			
				INITIAL REVISION:					
				DRWN: GGUNAGI		2016/11/09		DOCUMENT NUMBER	
				APPR: ISHWARG		2016/12/06		SD-87898-001	
				ANGULAR TOL ± 3.0°				DOC TYPE	
				DRAFT WHERE APPLICABLE MUST REMAIN WITHIN DIMENSIONS		THIRD ANGLE PROJECTION		DOC PART	
						DRAWING		REVISION	
						SERIES		000	
						MATERIAL NUMBER		B24	
						CUSTOMER			
						SEE TABLE		GENERAL MARKET	
						A3-SIZE		7 OF 21	
						87898			

DOCUMENT STATUS	P1	RELEASE DATE	2021/10/11	11:53:29
-----------------	----	--------------	------------	----------

10 9 8 7 6 5 4 3 2 1

PACKAGING OPTION PART NO.						CKT SIZE	VOID POSITION	PLATING TYPE	DIMENSION				
TRAY WITHOUT CAP	TRAY WITH CAP	TUBE WITHOUT CAP	TUBE WITH CAP	TAPE & REEL WITHOUT CAP	TAPE & REEL WITH CAP				A	B	G	F	M
-----	-----	87898-1921	87898-1931	-----	87898-1951	19	-----	1	48.26	45.72	10.81	9.65	5.84
-----	-----	87898-1922	87898-1932	-----	87898-1952	19	-----	2	48.26	45.72	10.81	9.65	5.84
-----	-----	87898-1924	87898-1934	-----	87898-1954	19	-----	4	48.26	45.72	10.81	9.65	5.84
-----	-----	87898-1925	87898-1935	-----	87898-1955	19	-----	5	48.26	45.72	10.81	9.65	5.84
-----	-----	87898-1926	87898-1936	-----	87898-1956	19	-----	6	48.26	45.72	10.81	9.65	5.84
-----	-----	87898-2021	87898-2031	-----	87898-2051	20	-----	1	50.80	48.26	10.81	9.65	5.84
-----	-----	87898-2022	87898-2032	-----	87898-2052	20	-----	2	50.80	48.26	10.81	9.65	5.84
-----	-----	87898-2024	87898-2034	-----	87898-2054	20	-----	4	50.80	48.26	10.81	9.65	5.84
-----	-----	87898-2025	87898-2035	-----	87898-2055	20	-----	5	50.80	48.26	10.81	9.65	5.84
-----	-----	87898-2026	87898-2036	-----	87898-2056	20	-----	6	50.80	48.26	10.81	9.65	5.84
-----	-----	87898-2027	87898-2037	-----	87898-2057	20	-----	6	50.80	48.26	10.81	9.65	5.84
-----	-----	87898-2121	87898-2131	-----	87898-2151	21	-----	1	53.34	50.80	10.81	9.65	5.84
-----	-----	87898-2122	87898-2132	-----	87898-2152	21	-----	2	53.34	50.80	10.81	9.65	5.84
-----	-----	87898-2124	87898-2134	-----	87898-2154	21	-----	4	53.34	50.80	10.81	9.65	5.84
-----	-----	87898-2125	87898-2135	-----	87898-2155	21	-----	5	53.34	50.80	10.81	9.65	5.84
-----	-----	87898-2126	87898-2136	-----	87898-2156	21	-----	6	53.34	50.80	10.81	9.65	5.84

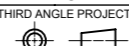
THIS DRAWING CONTAINS INFORMATION THAT IS PROPRIETARY TO MOLEX ELECTRONIC TECHNOLOGIES, LLC AND SHOULD NOT BE USED WITHOUT WRITTEN PERMISSION																	
DIMENSION UNITS		SCALE		CURRENT REV DESC: BRIGHT TIN PHASE OUT													
mm		NTS		EC NO: 679909 DRWN: AKUMAR19 2021/06/29 CHK'D: MRAMAKRISHNA 2021/10/11 APPR: MRAMAKRISHNA 2021/10/11 INITIAL REVISION: DRWN: GGUNAGI 2016/11/09 APPR: ISHWARG 2016/12/06								CUSTOMER					
GENERAL TOLERANCES (UNLESS SPECIFIED)										CUSTOMER						DOC TYPE	
										2.54MM PITCH SINGLE ROW SINGLE WAFER SMT HEADER						DOC PART	
										PRODUCT CUSTOMER DRAWING						REVISION	
4 PLACES ±										SD-87898-001						000	
3 PLACES ±																B24	
2 PLACES ± 0.2																	
1 PLACE ±																	
0 PLACES ±																	
ANGULAR TOL ± 3.0°																	
DRAFT WHERE APPLICABLE MUST REMAIN WITHIN DIMENSIONS				THIRD ANGLE PROJECTION		DRAWING		SERIES		MATERIAL NUMBER							
						A3-SIZE		87898		SEE TABLE							
								GENERAL MARKET		SHEET NUMBER							
										8 OF 21							

DOCUMENT STATUS	P1	RELEASE DATE	2021/10/11	11:53:29
-----------------	----	--------------	------------	----------

9 8 7 6 5 4 3 2 1

FORMAT: Mel-lega-master-ib-prod-A3  
 REVISION: E  
 DATE: 2020/01/14



PACKAGING OPTION PART NO.						CKT SIZE	VOID POSITION	PLATING TYPE	DIMENSION				
TRAY WITHOUT CAP	TRAY WITH CAP	TUBE WITHOUT CAP	TUBE WITH CAP	TAPE & REEL WITHOUT CAP	TAPE & REEL WITH CAP				A	B	G	F	M
-----	-----	87898-2221	87898-2231	-----	-----	22	----	1	55.88	53.34	10.81	9.65	5.84
-----	-----	87898-2222	87898-2232	-----	-----	22	----	2	55.88	53.34	10.81	9.65	5.84
-----	-----	87898-2224	87898-2234	-----	-----	22	----	4	55.88	53.34	10.81	9.65	5.84
-----	-----	87898-2225	87898-2235	-----	-----	22	----	5	55.88	53.34	10.81	9.65	5.84
-----	-----	87898-2226	87898-2236	-----	-----	22	----	6	55.88	53.34	10.81	9.65	5.84
-----	-----	87898-2321	87898-2331	-----	-----	23	----	1	58.42	55.88	10.81	9.65	5.84
-----	-----	87898-2322	87898-2332	-----	-----	23	----	2	58.42	55.88	10.81	9.65	5.84
-----	-----	87898-2324	87898-2334	-----	-----	23	----	4	58.42	55.88	10.81	9.65	5.84
-----	-----	87898-2325	87898-2335	-----	-----	23	----	5	58.42	55.88	10.81	9.65	5.84
-----	-----	87898-2326	87898-2336	-----	-----	23	----	6	58.42	55.88	10.81	9.65	5.84
-----	-----	87898-2421	87898-2431	-----	-----	24	----	1	60.96	58.42	10.81	9.65	5.84
-----	-----	87898-2422	87898-2432	-----	-----	24	----	2	60.96	58.42	10.81	9.65	5.84
-----	-----	87898-2424	87898-2434	-----	-----	24	----	4	60.96	58.42	10.81	9.65	5.84
-----	-----	87898-2425	87898-2435	-----	-----	24	----	5	60.96	58.42	10.81	9.65	5.84
-----	-----	87898-2426	87898-2436	-----	-----	24	----	6	60.96	58.42	10.81	9.65	5.84
-----	-----	87898-2427	87898-2437	-----	-----	24	----	6	60.96	58.42	10.81	9.65	5.84

B24

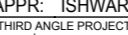
<p>THIS DRAWING CONTAINS INFORMATION THAT IS PROPRIETARY TO MOLEX ELECTRONIC TECHNOLOGIES, LLC AND SHOULD NOT BE USED WITHOUT WRITTEN PERMISSION</p> <table border="1"> <tr> <td>DIMENSION UNITS</td> <td>SCALE</td> <td colspan="2">CURRENT REV DESC: BRIGHT TIN PHASE OUT</td> </tr> <tr> <td>mm</td> <td>NTS</td> <td colspan="2"></td> </tr> <tr> <td colspan="4">GENERAL TOLERANCES (UNLESS SPECIFIED)</td> </tr> <tr> <td></td> <td>MM</td> <td>INCH</td> <td></td> </tr> <tr> <td>4 PLACES</td> <td>±</td> <td>±</td> <td></td> </tr> <tr> <td>3 PLACES</td> <td>±</td> <td>±</td> <td></td> </tr> <tr> <td>2 PLACES</td> <td>± 0.2</td> <td>±</td> <td></td> </tr> <tr> <td>1 PLACE</td> <td>±</td> <td>±</td> <td></td> </tr> <tr> <td>0 PLACES</td> <td>±</td> <td>±</td> <td></td> </tr> <tr> <td>ANGULAR TOL</td> <td>± 3.0°</td> <td></td> <td></td> </tr> </table>										DIMENSION UNITS	SCALE	CURRENT REV DESC: BRIGHT TIN PHASE OUT		mm	NTS			GENERAL TOLERANCES (UNLESS SPECIFIED)					MM	INCH		4 PLACES	±	±		3 PLACES	±	±		2 PLACES	± 0.2	±		1 PLACE	±	±		0 PLACES	±	±		ANGULAR TOL	± 3.0°			<p>EC NO: 679909          DRWN: AKUMAR19 2021/06/29          CHK'D: MRAMAKRISHNA 2021/10/11          APPR: MRAMAKRISHNA 2021/10/11</p>		<p><b>molex</b></p> <p>CUSTOM HEADER          2.54MM PITCH SINGLE ROW SINGLE WAFER SMT HEADER</p>		<p>PRODUCT CUSTOMER DRAWING</p>		<p>DOCUMENT NUMBER  <b>SD-87898-001</b></p>		<p>DOC TYPE DOC PART REVISION          PSD 000 B24</p>	
DIMENSION UNITS	SCALE	CURRENT REV DESC: BRIGHT TIN PHASE OUT																																																									
mm	NTS																																																										
GENERAL TOLERANCES (UNLESS SPECIFIED)																																																											
	MM	INCH																																																									
4 PLACES	±	±																																																									
3 PLACES	±	±																																																									
2 PLACES	± 0.2	±																																																									
1 PLACE	±	±																																																									
0 PLACES	±	±																																																									
ANGULAR TOL	± 3.0°																																																										
<p>DRAFT WHERE APPLICABLE MUST REMAIN WITHIN DIMENSIONS</p>				<p>THIRD ANGLE PROJECTION</p> 		<p>DRAWING  <b>A3-SIZE</b></p>		<p>SERIES  <b>87898</b></p>		<p>MATERIAL NUMBER          SEE TABLE</p>		<p>CUSTOMER          GENERAL MARKET</p>		<p>SHEET NUMBER          9 OF 21</p>																																													

DOCUMENT STATUS	P1	RELEASE DATE	2021/10/11	11:53:29
-----------------	----	--------------	------------	----------

10 9 8 7 6 5 4 3 2 1

PACKAGING OPTION PART NO.						CKT SIZE	VOID POSITION	PLATING TYPE	DIMENSION				
TRAY WITHOUT CAP	TRAY WITH CAP	TUBE WITHOUT CAP	TUBE WITH CAP	TAPE & REEL WITHOUT CAP	TAPE & REEL WITH CAP				A	B	G	F	M
-----	-----	87898-2521	87898-2531	-----	-----	25	----	1	63.50	60.96	10.81	9.65	5.84
-----	-----	87898-2522	87898-2532	-----	-----	25	----	2	63.50	60.96	10.81	9.65	5.84
-----	-----	87898-2524	87898-2534	-----	-----	25	----	4	63.50	60.96	10.81	9.65	5.84
-----	-----	87898-2525	87898-2535	-----	-----	25	----	5	63.50	60.96	10.81	9.65	5.84
-----	-----	87898-2526	87898-2536	-----	-----	25	----	6	63.50	60.96	10.81	9.65	5.84
-----	-----	87898-2621	87898-2631	-----	-----	26	----	1	66.04	63.50	10.81	9.65	5.84
-----	-----	87898-2622	87898-2632	-----	-----	26	----	2	66.04	63.50	10.81	9.65	5.84
-----	-----	87898-2624	87898-2634	-----	-----	26	----	4	66.04	63.50	10.81	9.65	5.84
-----	-----	87898-2625	87898-2635	-----	-----	26	----	5	66.04	63.50	10.81	9.65	5.84
-----	-----	87898-2626	87898-2636	-----	-----	26	----	6	66.04	63.50	10.81	9.65	5.84
-----	-----	87898-2627	87898-2637	-----	-----	26	----	6	66.04	63.50	10.81	9.65	5.84
-----	-----	87898-2721	87898-2731	-----	-----	27	----	1	68.58	66.04	10.81	9.65	5.84
-----	-----	87898-2722	87898-2732	-----	-----	27	----	2	68.58	66.04	10.81	9.65	5.84
-----	-----	87898-2724	87898-2734	-----	-----	27	----	4	68.58	66.04	10.81	9.65	5.84
-----	-----	87898-2725	87898-2735	-----	-----	27	----	5	68.58	66.04	10.81	9.65	5.84
-----	-----	87898-2726	87898-2736	-----	-----	27	----	6	68.58	66.04	10.81	9.65	5.84

(B24)

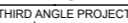
THIS DRAWING CONTAINS INFORMATION THAT IS PROPRIETARY TO MOLEX ELECTRONIC TECHNOLOGIES, LLC AND SHOULD NOT BE USED WITHOUT WRITTEN PERMISSION									
DIMENSION UNITS		SCALE		CURRENT REV DESC: BRIGHT TIN PHASE OUT					
mm		NTS							
GENERAL TOLERANCES (UNLESS SPECIFIED)				EC NO: 679909		2021/06/29		CUSTOM HEADER 2.54MM PITCH SINGLE ROW SINGLE WAFER SMT HEADER	
				DRWN: AKUMAR19		2021/10/11			
				CHK'D: MRAMAKRISHNA		2021/10/11		PRODUCT CUSTOMER DRAWING	
				APPR: MRAMAKRISHNA		2021/10/11			
				INITIAL REVISION:				DOCUMENT NUMBER <b>SD-87898-001</b>	
				DRWN: GGUNAGI		2016/11/09			
				APPR: ISHWARG		2016/12/06		DOC TYPE PSD	
				ANGULAR TOL ± 3.0°				DOC PART 000	
DRAFT WHERE APPLICABLE MUST REMAIN WITHIN DIMENSIONS				THIRD ANGLE PROJECTION		DRAWING		REVISION B24	
						SERIES A3-SIZE		SHEET NUMBER 10 OF 21	
						MATERIAL NUMBER SEE TABLE		CUSTOMER GENERAL MARKET	

DOCUMENT STATUS	P1	RELEASE DATE	2021/10/11	11:53:29
-----------------	----	--------------	------------	----------

9 8 7 6 5 4 3 2 1

FORMAT: Mel-lega-master-ib-prod-A3  
REVISION: E  
DATE: 2020/01/14

PACKAGING OPTION PART NO.						CKT SIZE	VOID POSITION	PLATING TYPE	DIMENSION				
TRAY WITHOUT CAP	TRAY WITH CAP	TUBE WITHOUT CAP	TUBE WITH CAP	TAPE & REEL WITHOUT CAP	TAPE & REEL WITH CAP				A	B	G	F	M
-----	-----	87898-2821	87898-2831	-----	-----	28	-----	1	71.12	68.58	10.81	9.65	5.84
-----	-----	87898-2822	87898-2832	-----	-----	28	-----	2	71.12	68.58	10.81	9.65	5.84
-----	-----	87898-2824	87898-2834	-----	-----	28	-----	4	71.12	68.58	10.81	9.65	5.84
-----	-----	87898-2825	87898-2835	-----	-----	28	-----	5	71.12	68.58	10.81	9.65	5.84
-----	-----	87898-2826	87898-2836	-----	-----	28	-----	6	71.12	68.58	10.81	9.65	5.84
-----	-----	87898-2921	87898-2931	-----	-----	29	-----	1	73.66	71.12	10.81	9.65	5.84
-----	-----	87898-2922	87898-2932	-----	-----	29	-----	2	73.66	71.12	10.81	9.65	5.84
-----	-----	87898-2924	87898-2934	-----	-----	29	-----	4	73.66	71.12	10.81	9.65	5.84
-----	-----	87898-2925	87898-2935	-----	-----	29	-----	5	73.66	71.12	10.81	9.65	5.84
-----	-----	87898-2926	87898-2936	-----	-----	29	-----	6	73.66	71.12	10.81	9.65	5.84
-----	-----	87898-3021	87898-3031	-----	-----	30	-----	1	76.20	73.66	10.81	9.65	5.84
-----	-----	87898-3022	87898-3032	-----	-----	30	-----	2	76.20	73.66	10.81	9.65	5.84
-----	-----	87898-3024	87898-3034	-----	-----	30	-----	4	76.20	73.66	10.81	9.65	5.84
-----	-----	87898-3025	87898-3035	-----	-----	30	-----	5	76.20	73.66	10.81	9.65	5.84
-----	-----	87898-3026	87898-3036	-----	-----	30	-----	6	76.20	73.66	10.81	9.65	5.84

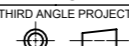
THIS DRAWING CONTAINS INFORMATION THAT IS PROPRIETARY TO MOLEX ELECTRONIC TECHNOLOGIES, LLC AND SHOULD NOT BE USED WITHOUT WRITTEN PERMISSION																	
DIMENSION UNITS		SCALE		CURRENT REV DESC: BRIGHT TIN PHASE OUT													
mm		NTS		EC NO: 679909 DRWN: AKUMAR19 2021/06/29 CHK'D: MRAMAKRISHNA 2021/10/11 APPR: MRAMAKRISHNA 2021/10/11 INITIAL REVISION: DRWN: GGUNAGI 2016/11/09 APPR: ISHWARG 2016/12/06								CUSTOMER					
GENERAL TOLERANCES (UNLESS SPECIFIED)										CUSTOMER		DOC TYPE		DOC PART		REVISION	
		MM								INCH		SD-87898-001		PSD		000 B24	
4 PLACES		±								±		SEE TABLE		GENERAL MARKET		11 OF 21	
3 PLACES		±								±							
2 PLACES		± 0.2								±							
1 PLACE		±		±													
0 PLACES		±		±													
ANGULAR TOL ± 3.0°				THIRD ANGLE PROJECTION		DRAWING		SERIES		MATERIAL NUMBER							
DRAFT WHERE APPLICABLE MUST REMAIN WITHIN DIMENSIONS						A3-SIZE		87898									

DOCUMENT STATUS	P1	RELEASE DATE	2021/10/11	11:53:29
-----------------	----	--------------	------------	----------

PACKAGING OPTION PART NO.						CKT SIZE	VOID POSITION	PLATING TYPE	DIMENSION				
TRAY WITHOUT CAP	TRAY WITH CAP	TUBE WITHOUT CAP	TUBE WITH CAP	TAPE & REEL WITHOUT CAP	TAPE & REEL WITH CAP				A	B	G	F	M
-----	-----	87898-3121	87898-3131	-----	-----	31	----	1	78.74	76.20	10.81	9.65	5.84
-----	-----	87898-3122	87898-3132	-----	-----	31	----	2	78.74	76.20	10.81	9.65	5.84
-----	-----	87898-3124	87898-3134	-----	-----	31	----	4	78.74	76.20	10.81	9.65	5.84
-----	-----	87898-3125	87898-3135	-----	-----	31	----	5	78.74	76.20	10.81	9.65	5.84
-----	-----	87898-3126	87898-3136	-----	-----	31	----	6	78.74	76.20	10.81	9.65	5.84
-----	-----	87898-3221	87898-3231	-----	-----	32	----	1	81.28	78.74	10.81	9.65	5.84
-----	-----	87898-3222	87898-3232	-----	-----	32	----	2	81.28	78.74	10.81	9.65	5.84
-----	-----	87898-3224	87898-3234	-----	-----	32	----	4	81.28	78.74	10.81	9.65	5.84
-----	-----	87898-3225	87898-3235	-----	-----	32	----	5	81.28	78.74	10.81	9.65	5.84
-----	-----	87898-3226	87898-3236	-----	-----	32	----	6	81.28	78.74	10.81	9.65	5.84
-----	-----	87898-3227	87898-3237	-----	-----	32	----	6	81.28	78.74	10.81	9.65	5.84
-----	-----	87898-3321	87898-3331	-----	-----	33	----	1	83.82	81.28	10.81	9.65	5.84
-----	-----	87898-3322	87898-3332	-----	-----	33	----	2	83.82	81.28	10.81	9.65	5.84
-----	-----	87898-3324	87898-3334	-----	-----	33	----	4	83.82	81.28	10.81	9.65	5.84
-----	-----	87898-3325	87898-3335	-----	-----	33	----	5	83.82	81.28	10.81	9.65	5.84
-----	-----	87898-3326	87898-3336	-----	-----	33	----	6	83.82	81.28	10.81	9.65	5.84

(B24)

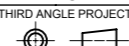
THIS DRAWING CONTAINS INFORMATION THAT IS PROPRIETARY TO MOLEX ELECTRONIC TECHNOLOGIES, LLC AND SHOULD NOT BE USED WITHOUT WRITTEN PERMISSION																	
DIMENSION UNITS		SCALE		CURRENT REV DESC: BRIGHT TIN PHASE OUT													
mm		NTS		EC NO: 679909 DRWN: AKUMAR19 2021/06/29 CHK'D: MRAMAKRISHNA 2021/10/11 APPR: MRAMAKRISHNA 2021/10/11 INITIAL REVISION: DRWN: GGUNAGI 2016/11/09 APPR: ISHWARG 2016/12/06								CUSTOMER					
GENERAL TOLERANCES (UNLESS SPECIFIED)										CUSTOMER		DOC TYPE		DOC PART		REVISION	
		MM								INCH		SD-87898-001		PSD		000 B24	
4 PLACES		±								±		SEE TABLE		GENERAL MARKET		12 OF 21	
3 PLACES		±								±							
2 PLACES		± 0.2								±							
1 PLACE		±		±													
0 PLACES		±		±													
ANGULAR TOL ± 3.0°				THIRD ANGLE PROJECTION		DRAWING		SERIES		MATERIAL NUMBER							
DRAFT WHERE APPLICABLE MUST REMAIN WITHIN DIMENSIONS						A3-SIZE		87898									

DOCUMENT STATUS	P1	RELEASE DATE	2021/10/11	11:53:29
-----------------	----	--------------	------------	----------

PACKAGING OPTION PART NO.						CKT SIZE	VOID POSITION	PLATING TYPE	DIMENSION				
TRAY WITHOUT CAP	TRAY WITH CAP	TUBE WITHOUT CAP	TUBE WITH CAP	TAPE & REEL WITHOUT CAP	TAPE & REEL WITH CAP				A	B	G	F	M
-----	-----	87898-3421	87898-3431	-----	-----	34	-----	1	86.36	83.82	10.81	9.65	5.84
-----	-----	87898-3422	87898-3432	-----	-----	34	-----	2	86.36	83.82	10.81	9.65	5.84
-----	-----	87898-3424	87898-3434	-----	-----	34	-----	4	86.36	83.82	10.81	9.65	5.84
-----	-----	87898-3425	87898-3435	-----	-----	34	-----	5	86.36	83.82	10.81	9.65	5.84
-----	-----	87898-3426	87898-3436	-----	-----	34	-----	6	86.36	83.82	10.81	9.65	5.84
-----	-----	87898-3521	87898-3531	-----	-----	35	-----	1	88.90	86.36	10.81	9.65	5.84
-----	-----	87898-3522	87898-3532	-----	-----	35	-----	2	88.90	86.36	10.81	9.65	5.84
-----	-----	87898-3524	87898-3534	-----	-----	35	-----	4	88.90	86.36	10.81	9.65	5.84
-----	-----	87898-3525	87898-3535	-----	-----	35	-----	5	88.90	86.36	10.81	9.65	5.84
-----	-----	87898-3526	87898-3536	-----	-----	35	-----	6	88.90	86.36	10.81	9.65	5.84
-----	-----	87898-3621	87898-3631	-----	-----	36	-----	1	91.44	88.90	10.81	9.65	5.84
-----	-----	87898-3622	87898-3632	-----	-----	36	-----	2	91.44	88.90	10.81	9.65	5.84
-----	-----	87898-3624	87898-3634	-----	-----	36	-----	4	91.44	88.90	10.81	9.65	5.84
-----	-----	87898-3625	87898-3635	-----	-----	36	-----	5	91.44	88.90	10.81	9.65	5.84
-----	-----	87898-3626	87898-3636	-----	-----	36	-----	6	91.44	88.90	10.81	9.65	5.84

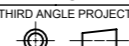
THIS DRAWING CONTAINS INFORMATION THAT IS PROPRIETARY TO MOLEX ELECTRONIC TECHNOLOGIES, LLC AND SHOULD NOT BE USED WITHOUT WRITTEN PERMISSION																	
DIMENSION UNITS		SCALE		CURRENT REV DESC: BRIGHT TIN PHASE OUT													
mm		NTS		EC NO: 679909 DRWN: AKUMAR19 2021/06/29 CHK'D: MRAMAKRISHNA 2021/10/11 APPR: MRAMAKRISHNA 2021/10/11 INITIAL REVISION: DRWN: GGUNAGI 2016/11/09 APPR: ISHWARG 2016/12/06								CUSTOMER					
GENERAL TOLERANCES (UNLESS SPECIFIED)										CUSTOMER		DOC TYPE		DOC PART		REVISION	
		MM								INCH		SD-87898-001		PSD		000 B24	
4 PLACES		±								±		SEE TABLE		GENERAL MARKET		13 OF 21	
3 PLACES		±								±							
2 PLACES		± 0.2								±							
1 PLACE		±		±													
0 PLACES		±		±													
ANGULAR TOL ± 3.0°				THIRD ANGLE PROJECTION		DRAWING		SERIES		MATERIAL NUMBER							
DRAFT WHERE APPLICABLE MUST REMAIN WITHIN DIMENSIONS						A3-SIZE		87898									

DOCUMENT STATUS	P1	RELEASE DATE	2021/10/11	11:53:29
-----------------	----	--------------	------------	----------

PACKAGING OPTION PART NO.						CKT SIZE	VOID POSITION	PLATING TYPE	DIMENSION				
TRAY WITHOUT CAP	TRAY WITH CAP	TUBE WITHOUT CAP	TUBE WITH CAP	TAPE & REEL WITHOUT CAP	TAPE & REEL WITH CAP				A	B	G	F	M
-----	-----	87898-3721	87898-3731	-----	-----	37	----	1	93.98	91.44	10.81	9.65	5.84
-----	-----	87898-3722	87898-3732	-----	-----	37	----	2	93.98	91.44	10.81	9.65	5.84
-----	-----	87898-3724	87898-3734	-----	-----	37	----	4	93.98	91.44	10.81	9.65	5.84
-----	-----	87898-3725	87898-3735	-----	-----	37	----	5	93.98	91.44	10.81	9.65	5.84
-----	-----	87898-3726	87898-3736	-----	-----	37	----	6	93.98	91.44	10.81	9.65	5.84
-----	-----	87898-3821	87898-3831	-----	-----	38	----	1	96.52	93.98	10.81	9.65	5.84
-----	-----	87898-3822	87898-3832	-----	-----	38	----	2	96.52	93.98	10.81	9.65	5.84
-----	-----	87898-3824	87898-3834	-----	-----	38	----	4	96.52	93.98	10.81	9.65	5.84
-----	-----	87898-3825	87898-3835	-----	-----	38	----	5	96.52	93.98	10.81	9.65	5.84
-----	-----	87898-3826	87898-3836	-----	-----	38	----	6	96.52	93.98	10.81	9.65	5.84
-----	-----	87898-3921	87898-3931	-----	-----	39	----	1	99.06	96.52	10.81	9.65	5.84
-----	-----	87898-3922	87898-3932	-----	-----	39	----	2	99.06	96.52	10.81	9.65	5.84
-----	-----	87898-3924	87898-3934	-----	-----	39	----	4	99.06	96.52	10.81	9.65	5.84
-----	-----	87898-3925	87898-3935	-----	-----	39	----	5	99.06	96.52	10.81	9.65	5.84
-----	-----	87898-3926	87898-3936	-----	-----	39	----	6	99.06	96.52	10.81	9.65	5.84

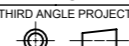
THIS DRAWING CONTAINS INFORMATION THAT IS PROPRIETARY TO MOLEX ELECTRONIC TECHNOLOGIES, LLC AND SHOULD NOT BE USED WITHOUT WRITTEN PERMISSION																	
DIMENSION UNITS		SCALE		CURRENT REV DESC: BRIGHT TIN PHASE OUT													
mm		NTS		EC NO: 679909 DRWN: AKUMAR19 2021/06/29 CHK'D: MRAMAKRISHNA 2021/10/11 APPR: MRAMAKRISHNA 2021/10/11 INITIAL REVISION: DRWN: GGUNAGI 2016/11/09 APPR: ISHWARG 2016/12/06								CUSTOMER					
GENERAL TOLERANCES (UNLESS SPECIFIED)										CUSTOMER						DOC TYPE	
										2.54MM PITCH SINGLE ROW SINGLE WAFER SMT HEADER						DOC PART	
										PRODUCT CUSTOMER DRAWING						REVISION	
4 PLACES ±										SD-87898-001						000	
3 PLACES ±																B24	
2 PLACES ± 0.2																	
1 PLACE ±																	
0 PLACES ±																	
ANGULAR TOL ± 3.0°																	
DRAFT WHERE APPLICABLE MUST REMAIN WITHIN DIMENSIONS				THIRD ANGLE PROJECTION		DRAWING		SERIES		MATERIAL NUMBER							
						A3-SIZE		87898		SEE TABLE							
								GENERAL MARKET		14 OF 21							

DOCUMENT STATUS	P1	RELEASE DATE	2021/10/11	11:53:29
-----------------	----	--------------	------------	----------

PACKAGING OPTION PART NO.						CKT SIZE	VOID POSITION	PLATING TYPE	DIMENSION				
TRAY WITHOUT CAP	TRAY WITH CAP	TUBE WITHOUT CAP	TUBE WITH CAP	TAPE & REEL WITHOUT CAP	TAPE & REEL WITH CAP				A	B	G	F	M
-----	-----	87898-4021	87898-4031	-----	-----	40	-----	1	101.60	99.06	10.81	9.65	5.84
-----	-----	87898-4022	87898-4032	-----	-----	40	-----	2	101.60	99.06	10.81	9.65	5.84
-----	-----	87898-4024	87898-4034	-----	-----	40	-----	4	101.60	99.06	10.81	9.65	5.84
-----	-----	87898-4025	87898-4035	-----	-----	40	-----	5	101.60	99.06	10.81	9.65	5.84
-----	-----	87898-4026	87898-4036	-----	-----	40	-----	6	101.60	99.06	10.81	9.65	5.84

THIS DRAWING CONTAINS INFORMATION THAT IS PROPRIETARY TO MOLEX ELECTRONIC TECHNOLOGIES, LLC AND SHOULD NOT BE USED WITHOUT WRITTEN PERMISSION																	
DIMENSION UNITS		SCALE		CURRENT REV DESC: BRIGHT TIN PHASE OUT						<b>molex</b>							
mm		NTS															
GENERAL TOLERANCES (UNLESS SPECIFIED)				EC NO: 679909 DRWN: AKUMAR19 2021/06/29 CHK'D: MRAMAKRISHNA 2021/10/11 APPR: MRAMAKRISHNA 2021/10/11 INITIAL REVISION: DRWN: GGUNAGI 2016/11/09 APPR: ISHWARG 2016/12/06						CUSTOM HEADER		2.54MM PITCH SINGLE ROW SINGLE WAFER SMT HEADER					
										PRODUCT CUSTOMER DRAWING							
										DOCUMENT NUMBER		SD-87898-001		DOC TYPE		PSD	
										DOC PART		000		REVISION		B24	
										SHEET NUMBER		15 OF 21					
DRAFT WHERE APPLICABLE MUST REMAIN WITHIN DIMENSIONS		THIRD ANGLE PROJECTION		DRAWING		SERIES		MATERIAL NUMBER		CUSTOMER							
				A3-SIZE		87898		SEE TABLE		GENERAL MARKET							

DOCUMENT STATUS	P1	RELEASE DATE	2021/10/11	11:53:29
-----------------	----	--------------	------------	----------

# CAP ORIENTATION (CAP P/N: 87938-0001)

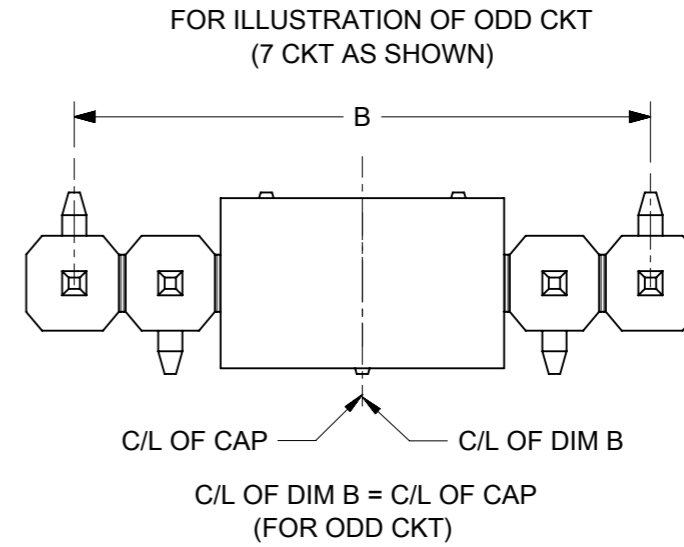
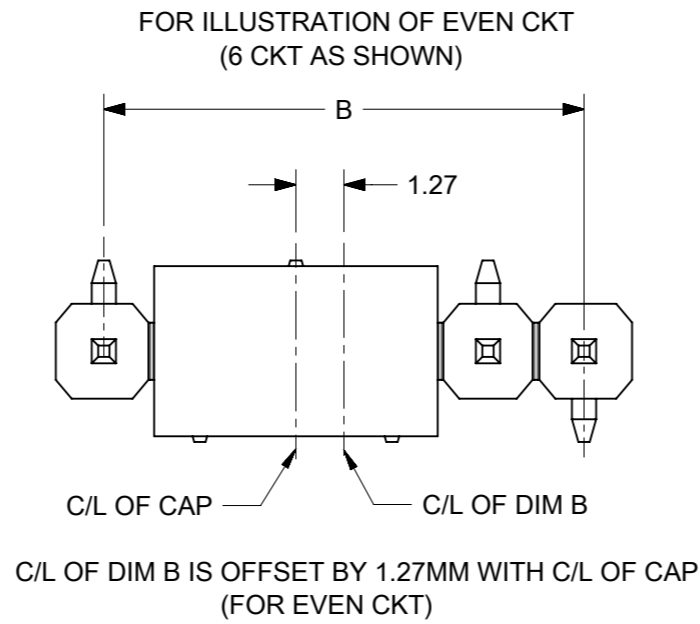

# CAP ORIENTATION (CAP P/N: 87898-1000)

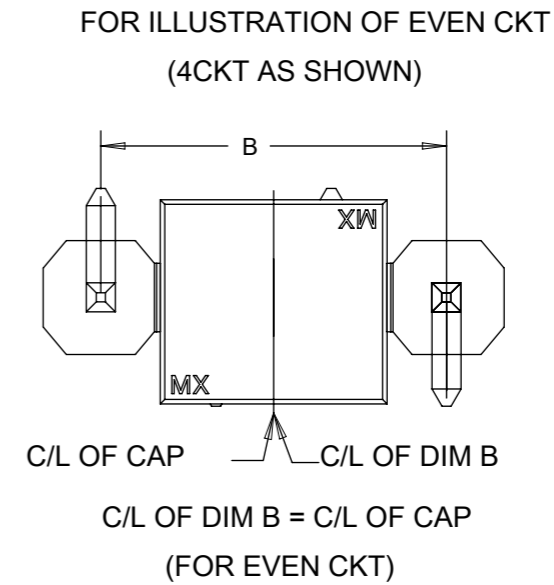
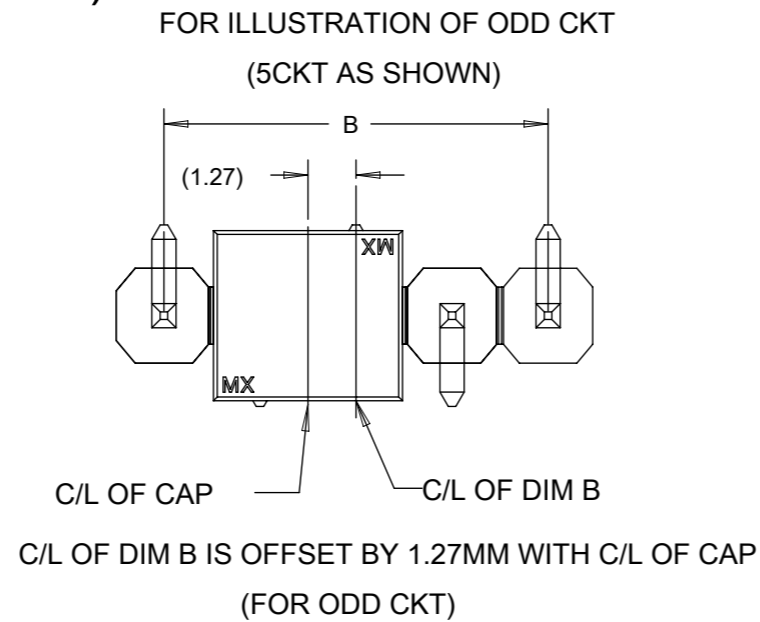

# PART ORIENTATION IN TUBE



PART WITHOUT CAP      PART WITH CAP

THIS DRAWING CONTAINS INFORMATION THAT IS PROPRIETARY TO MOLEX ELECTRONIC TECHNOLOGIES, LLC AND SHOULD NOT BE USED WITHOUT WRITTEN PERMISSION									
DIMENSION UNITS		SCALE		CURRENT REV DESC: BRIGHT TIN PHASE OUT					
mm		NTS							
GENERAL TOLERANCES (UNLESS SPECIFIED)									
		MM	INCH	EC NO: 679909 DRWN: AKUMAR19      2021/06/29 CHK'D: MRAMAKRISHNA      2021/10/11 APPR: MRAMAKRISHNA      2021/10/11 INITIAL REVISION: DRWN: GGUNAGI      2016/11/09 APPR: ISHWARG      2016/12/06					
4 PLACES	±	±	±						
3 PLACES	±	±	±						
2 PLACES	±	0.2	±						
1 PLACE	±	±	±						
0 PLACES	±	±	±	DOCUMENT NUMBER		DOC TYPE	DOC PART	REVISION	
ANGULAR TOL		± 3.0°		SD-87898-001		PSD	000	B24	
DRAFT WHERE APPLICABLE MUST REMAIN WITHIN DIMENSIONS		THIRD ANGLE PROJECTION		DRAWING	SERIES	MATERIAL NUMBER	CUSTOMER	SHEET NUMBER	
				A3-SIZE	87898	SEE TABLE	GENERAL MARKET	16 OF 21	



EMBOSED CARRIER TYPE 'A'

CKT	DIMENSION				
	Bo	Ao	Ko	F	W
2	8.02	5.20	13.60	11.50	24.00
3	8.02	5.20	13.60	11.50	24.00
4	10.55	5.20	13.60	11.50	24.00

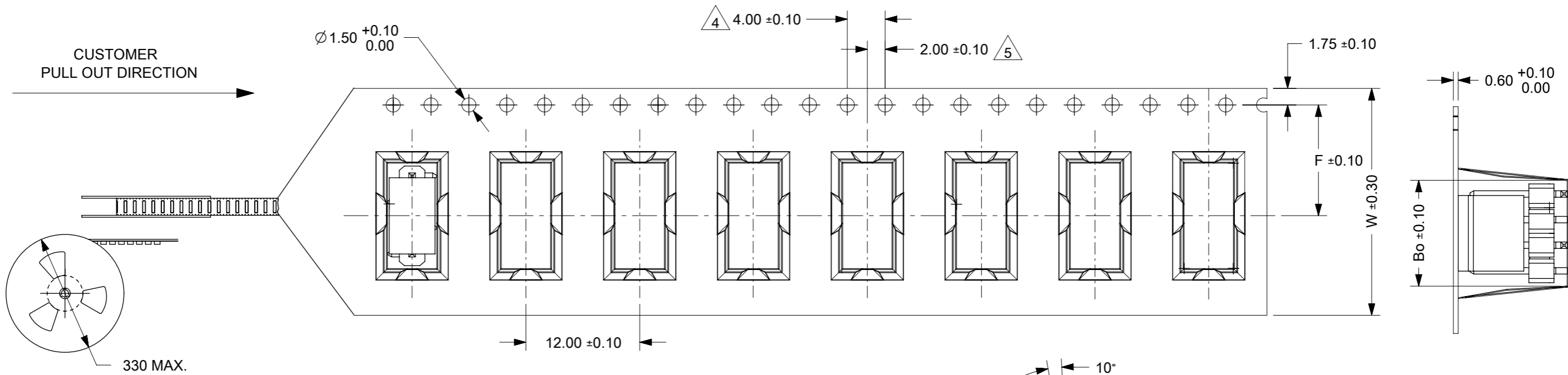

NOTES:  
1. LEADER AND TRAILER TAPE

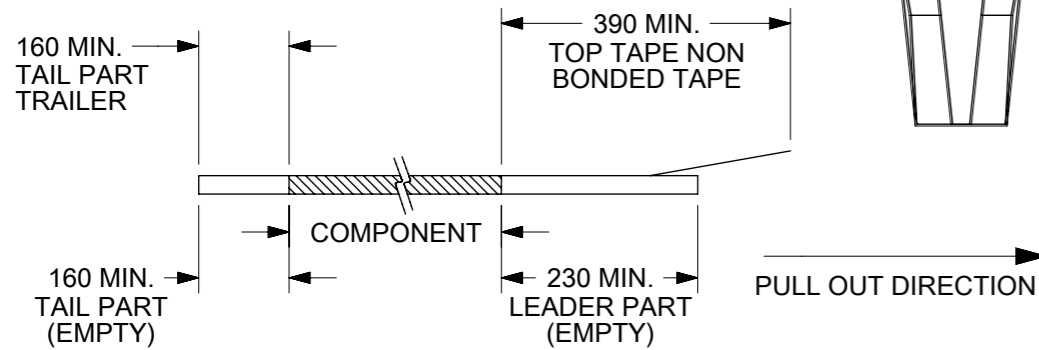

2. PEELING OFF FORCE OF THE TOP TAPE: 20 - 80gf.  
(PEELING DIRECTION AS SHOWN IN FOLLOWING FIGURE)

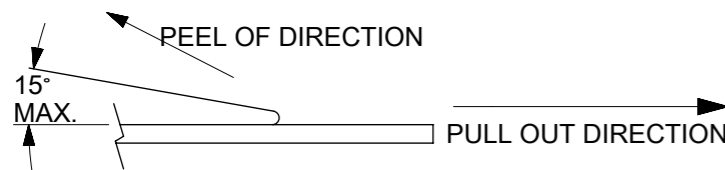

3. MATERIAL: BLACK P.S CONDUCTIVE, BLACK

4. MEASURED FROM CENTRELINE OF SPROCKET HOLE TO CENTRELINE OF SPOCKET

5. CUMULATIVE TOLERANCE OF 10 SPROCKET HOLE IS  $\pm 0.20\text{mm}$

6. A0 AND B0 ARE MEASURE FROM ABOVE POCKET BASE  $0.30\text{mm}$

7. TAPE AND REEL SPECIFICATION IS AS PER EIA-481.

8. TAPE AND REEL QUANTITY : 440PCS/REEL

9. THE TAPE IS TREATED FOR ANTI-STATIC.

10. ALL RADIUS ARE  $0.30\text{mm}$  UNLESS SPECIFY

11. SURFACE RESISTIVITY  $10^3$  TO  $10$  OHMS.

PART PACK  
IN E/TAPE  
ORIENTATION  
(FOR REF USE)

THIS DRAWING CONTAINS INFORMATION THAT IS PROPRIETARY TO MOLEX ELECTRONIC TECHNOLOGIES, LLC AND SHOULD NOT BE USED WITHOUT WRITTEN PERMISSION		CURRENT REV DESC: BRIGHT TIN PHASE OUT			
DIMENSION UNITS: mm SCALE: NTS		EC NO: 679909 DRWN: AKUMAR19 CHK'D: MRAMAKRISHNA APPR: MRAMAKRISHNA			
GENERAL TOLERANCES (UNLESS SPECIFIED)		INITIAL REVISION:		PRODUCT CUSTOMER DRAWING	
4 PLACES $\pm$ $\pm$ 3 PLACES $\pm$ $\pm$ 2 PLACES $\pm 0.2$ $\pm$ 1 PLACE $\pm$ $\pm$ 0 PLACES $\pm$ $\pm$		DRWN: GGUNAGI APPR: ISHWARG		DOCUMENT NUMBER: SD-87898-001 DOC TYPE: PSD DOC PART: 000 REVISION: B24	
ANGULAR TOL $\pm 3.0^\circ$		DRAFT WHERE APPLICABLE MUST REMAIN WITHIN DIMENSIONS		MATERIAL NUMBER: SEE TABLE CUSTOMER: GENERAL MARKET SHEET NUMBER: 17 OF 21	

CKT	DIMENSION				
	Bo	Ao	Ko	F	W
5	13.10	5.20	11.30	11.50	24.00

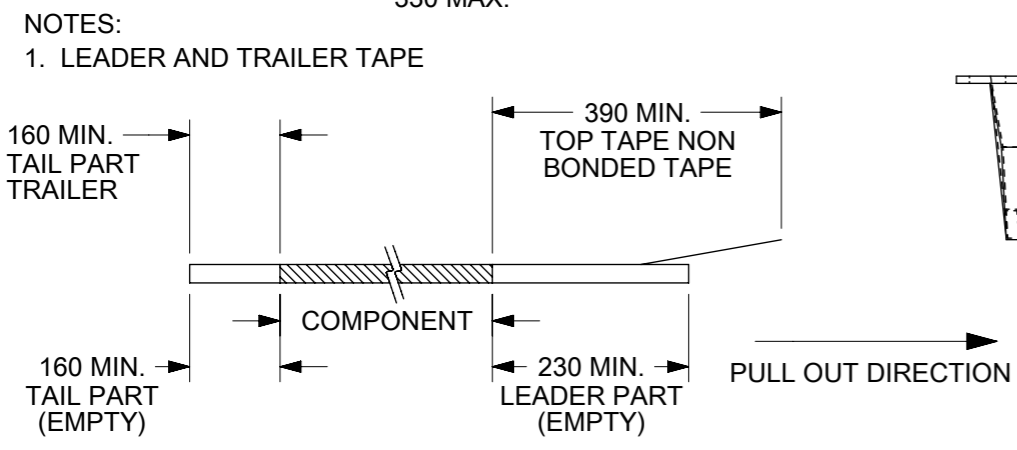
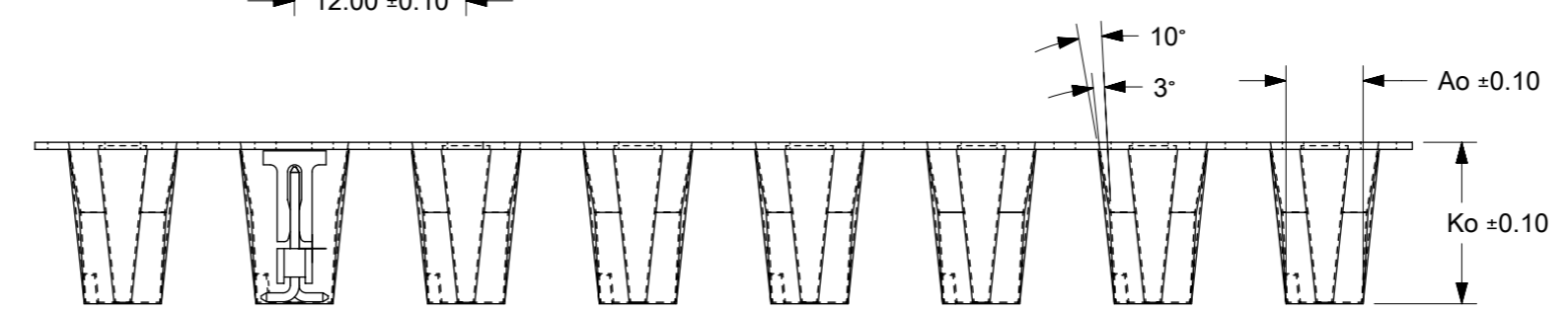
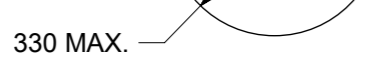

PART PACK  
IN E/TAPE  
ORIENTATION  
(FOR REF USE)

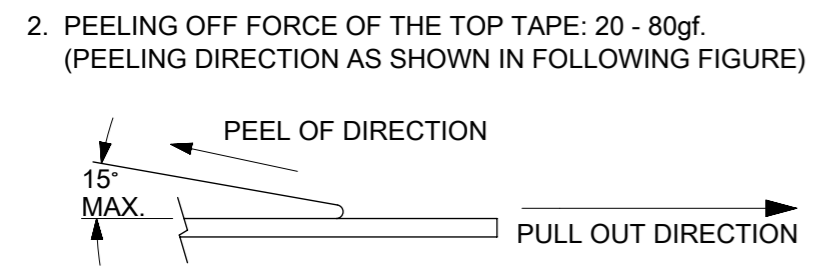

- LEADER AND TRAILER TAPE
- PEELING OFF FORCE OF THE TOP TAPE: 20 - 80gf.  
(PEELING DIRECTION AS SHOWN IN FOLLOWING FIGURE)
- MATERIAL: BLACK P.S CONDUCTIVE, BLACK
- MEASURED FROM CENTRELINE OF SPROCKET HOLE TO CENTRELINE OF SPOCKET
- CUMULATIVE TOLERANCE OF 10 SPROCKET HOLE IS ±0.20mm
- A0 AND B0 ARE MEASURE FROM ABOVE POCKET BASE 0.30mm
- TAPE AND REEL SPECIFICATION IS AS PER EIA-481.
- TAPE AND REEL QUANTITY : 440PCS/REEL
- THE TAPE IS TREATED FOR ANTI-STATIC.
- ALL RADIUS ARE 0.30MM UNLESS SPECIFY
- SURFACE RESISTIVITY 10<sup>3</sup> TO 10 OHMS.

THIS DRAWING CONTAINS INFORMATION THAT IS PROPRIETARY TO MOLEX ELECTRONIC TECHNOLOGIES, LLC AND SHOULD NOT BE USED WITHOUT WRITTEN PERMISSION		CURRENT REV DESC: BRIGHT TIN PHASE OUT		<b>molex</b>	
CUSTOMER HEADER 2.54MM PITCH SINGLE ROW SINGLE WAFER SMT HEADER		PRODUCT CUSTOMER DRAWING			
EC NO: 679909		DRWN: AKUMAR19 2021/06/29		DOCUMENT NUMBER	
CHK'D: MRAMAKRISHNA		APPR: MRAMAKRISHNA 2021/10/11		SD-87898-001	
INITIAL REVISION:		DRWN: GGUNAGI 2016/11/09		DOC TYPE	
APPR: ISHWARG 2016/12/06		SERIES		PSD	
DRAFT WHERE APPLICABLE MUST REMAIN WITHIN DIMENSIONS		THIRD ANGLE PROJECTION		DOC PART	
DRAWING		SERIES		000	
A3-SIZE		87898		REVISION	
MATERIAL NUMBER		CUSTOMER		B24	
SEE TABLE		GENERAL MARKET		SHEET NUMBER	
18 OF 21					

10 9 8 7 6 5 4 3 2 1

F

E

D

C

B

A

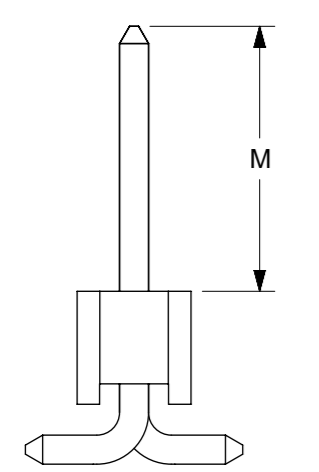

NOTES:  
1. LEADER AND TRAILER TAPE

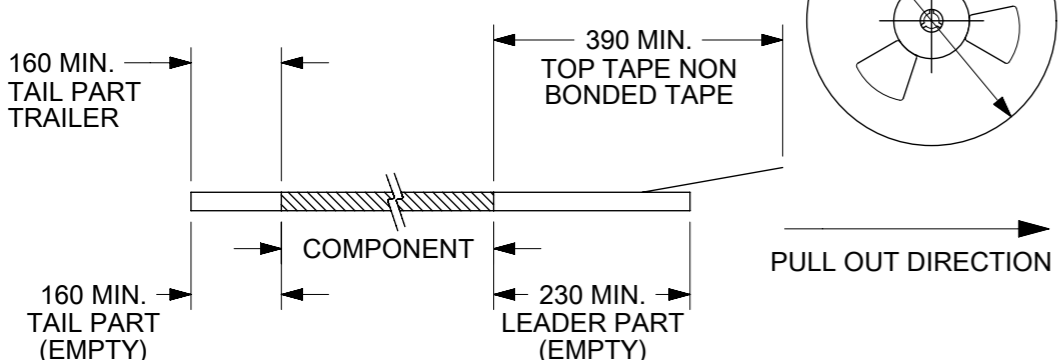

2. PEELING OFF FORCE OF THE TOP TAPE: 20 - 80gf.  
(PEELING DIRECTION AS SHOWN IN FOLLOWING FIGURE)

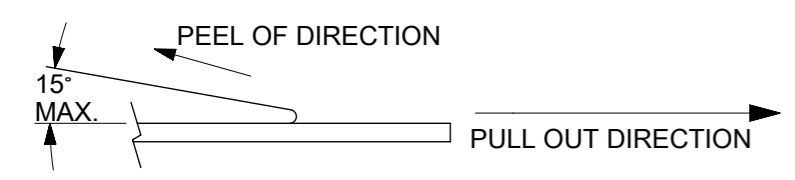

- 3. MATERIAL: BLACK P.S CONDUCTIVE, BLACK
- 4. MEASURED FROM CENTRELINE OF SPROCKET HOLE TO CENTRELINE OF SPOCKET
- 5. CUMULATIVE TOLERANCE OF 10 SPROCKET HOLE IS ±0.20mm
- 6. A0 AND B0 ARE MEASURE FROM ABOVE POCKET BASE 0.30mm
- 7. TAPE AND REEL SPECIFICATION IS AS PER EIA-481.
- 8. TAPE AND REEL QUANTITY : SEE TABLE
- 9. THE TAPE IS TREATED FOR ANTI-STATIC.
- 10. ALL RADIUS ARE 0.30MM UNLESS SPECIFY
- 11. SURFACE RESISTIVITY 10<sup>3</sup> TO 10 OHMS.

CKT	DIMENSION							TYPE	QTY/ REEL
	M	Bo	So	Ao	Ko	F	W		
6	11.50	15.65	28.40	5.20	16.90	14.20	32.00	A	150
6	5.84	15.65	28.40	5.20	11.30	14.20	32.00	B	440
8		20.70	40.40	5.20	11.30	20.20	44.00		
10		25.80	40.40	5.20	11.30	20.20	44.00		
12		30.90	52.40	5.20	11.30	26.20	56.00		
14		35.95	52.40	5.20	11.30	26.20	56.00		
16		41.05	52.40	5.20	11.30	26.20	56.00		
18		46.20	68.40	5.20	11.30	34.20	72.00		
20		51.20	68.40	5.20	11.30	34.20	72.00		

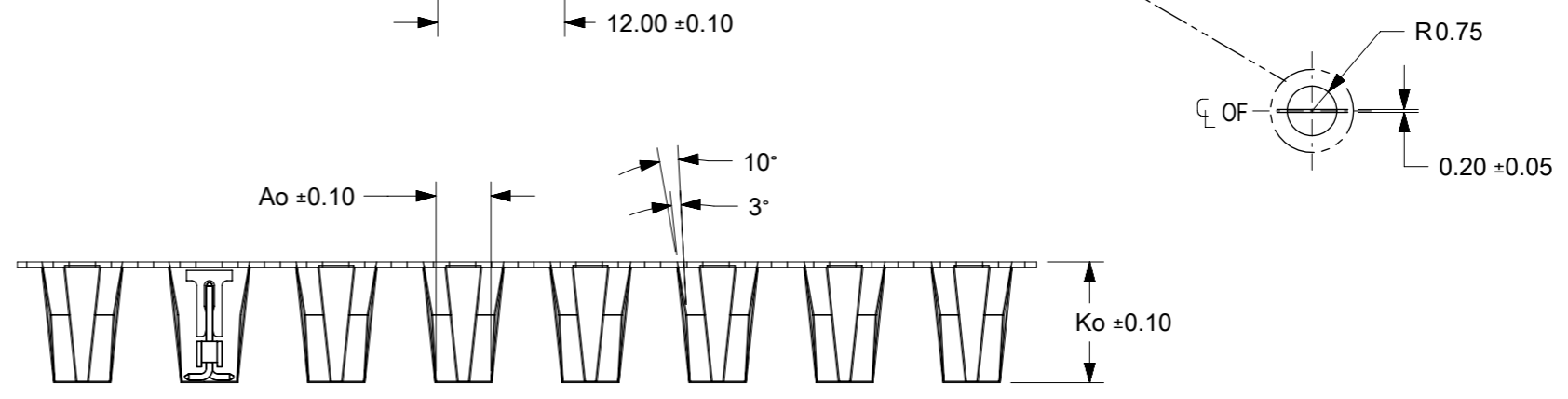

THIS DRAWING CONTAINS INFORMATION THAT IS PROPRIETARY TO MOLEX ELECTRONIC TECHNOLOGIES, LLC AND SHOULD NOT BE USED WITHOUT WRITTEN PERMISSION

DIMENSION UNITS	SCALE	CURRENT REV DESC: BRIGHT TIN PHASE OUT	
mm	NTS		
GENERAL TOLERANCES (UNLESS SPECIFIED)			
	MM	INCH	
4 PLACES	±	±	
3 PLACES	±	±	
2 PLACES	± 0.2	±	
1 PLACE	±	±	
0 PLACES	±	±	
ANGULAR TOL	± 3.0°		
DRAFT WHERE APPLICABLE MUST REMAIN WITHIN DIMENSIONS		THIRD ANGLE PROJECTION	DRAWING SERIES
			A3-SIZE 87898
EC NO: 679909		DRWN: AKUMAR19	2021/06/29
CHK'D: MRAMAKRISHNA		APPR: MRAMAKRISHNA	2021/10/11
INITIAL REVISION:		DRWN: GGUNAGI	2016/11/09
		APPR: ISHWARG	2016/12/06
DOCUMENT NUMBER		DOC TYPE	DOC PART REVISION
SD-87898-001		PSD	000 B24
MATERIAL NUMBER		CUSTOMER	SHEET NUMBER
SEE TABLE		GENERAL MARKET	19 OF 21

9 8 7 6 5 4 3 2 1

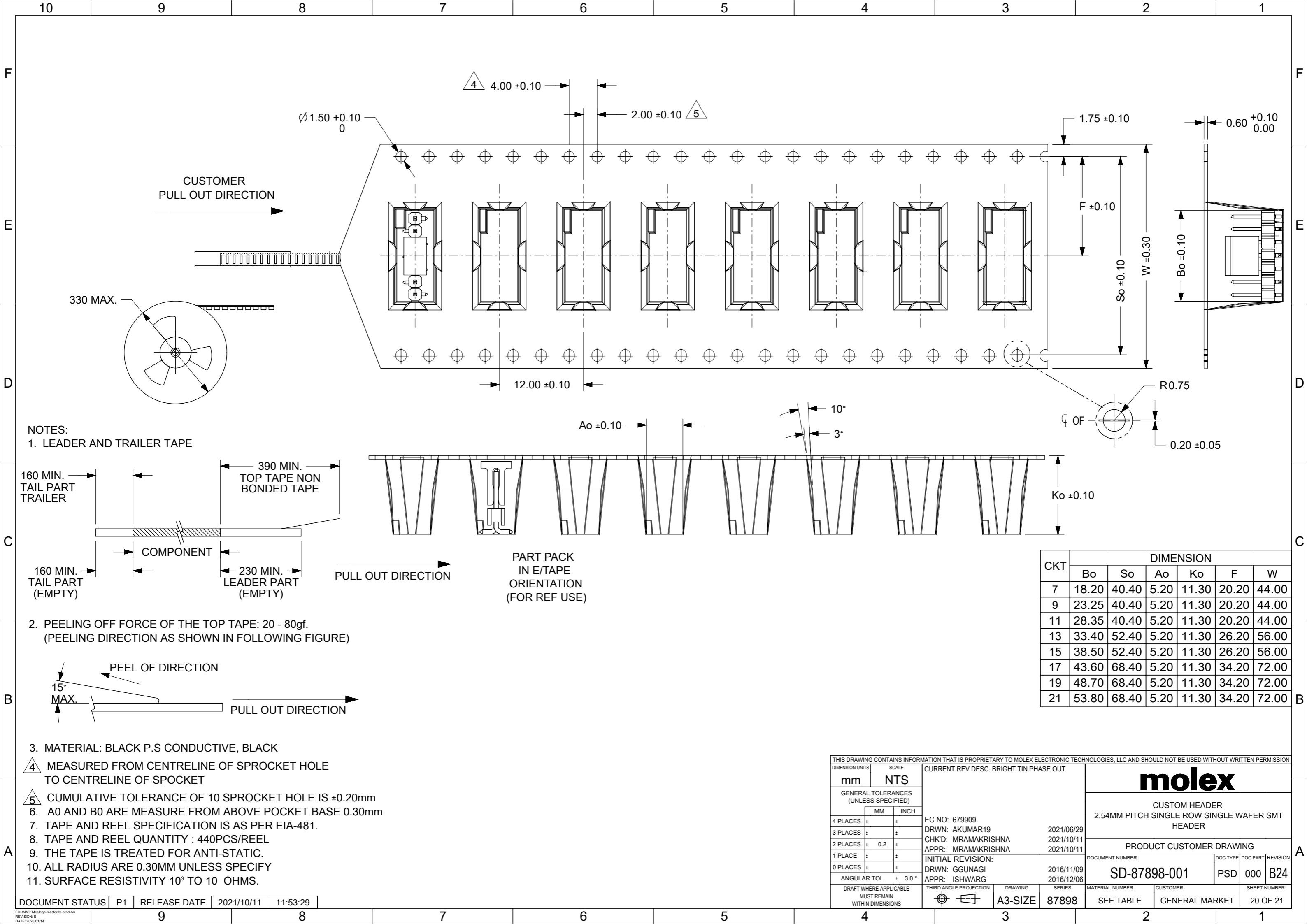

THIS DRAWING CONTAINS INFORMATION THAT IS PROPRIETARY TO MOLEX ELECTRONIC TECHNOLOGIES, LLC AND SHOULD NOT BE USED WITHOUT WRITTEN PERMISSION

DIMENSION UNITS	SCALE	CURRENT REV DESC: BRIGHT TIN PHASE OUT	
mm	NTS		
GENERAL TOLERANCES (UNLESS SPECIFIED)			
	MM	INCH	
4 PLACES	±	±	
3 PLACES	±	±	
2 PLACES	± 0.2	±	
1 PLACE	±	±	
0 PLACES	±	±	
ANGULAR TOL	± 3.0°		
DRAFT WHERE APPLICABLE MUST REMAIN WITHIN DIMENSIONS		THIRD ANGLE PROJECTION	DRAWING
			A3-SIZE
		SERIES	87898
		MATERIAL NUMBER	SEE TABLE
		CUSTOMER	GENERAL MARKET
		SHEET NUMBER	20 OF 21

EC NO: 679909  
 DRWN: AKUMAR19 2021/06/29  
 CHK'D: MRAMAKRISHNA 2021/10/11  
 APPR: MRAMAKRISHNA 2021/10/11

INITIAL REVISION:  
 DRWN: GGUNAGI 2016/11/09  
 APPR: ISHWARG 2016/12/06

**molex**  
 CUSTOM HEADER  
 2.54MM PITCH SINGLE ROW SINGLE WAFER SMT HEADER

PRODUCT CUSTOMER DRAWING

DOCUMENT NUMBER: SD-87898-001  
 DOC TYPE: PSD  
 DOC PART: 000  
 REVISION: B24

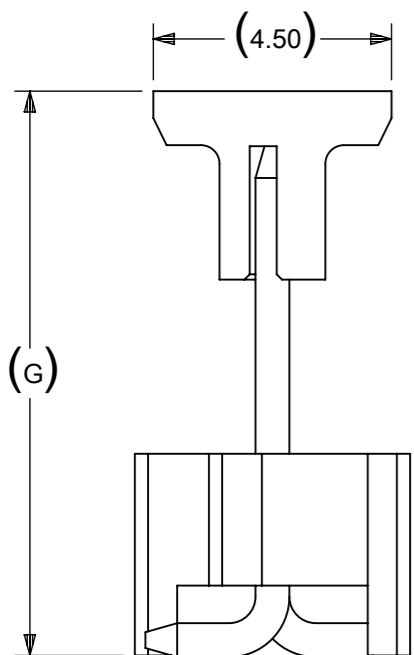
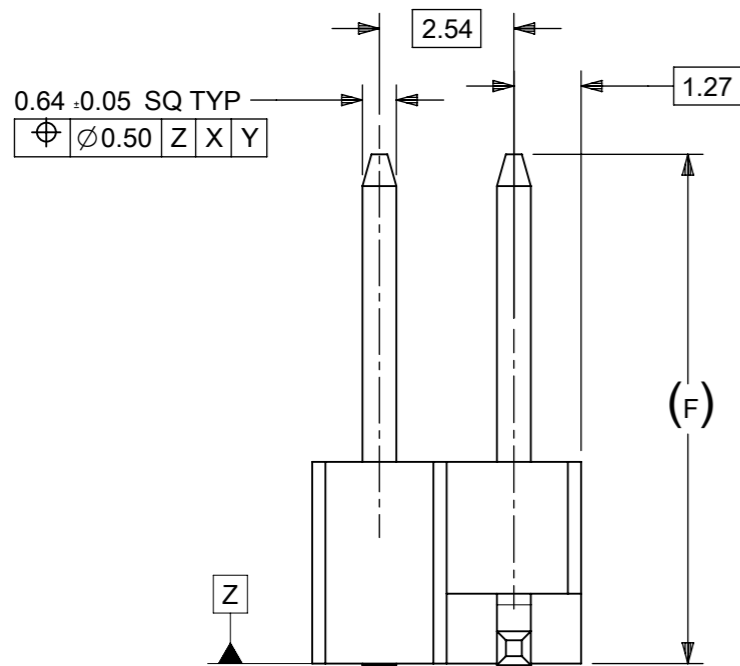
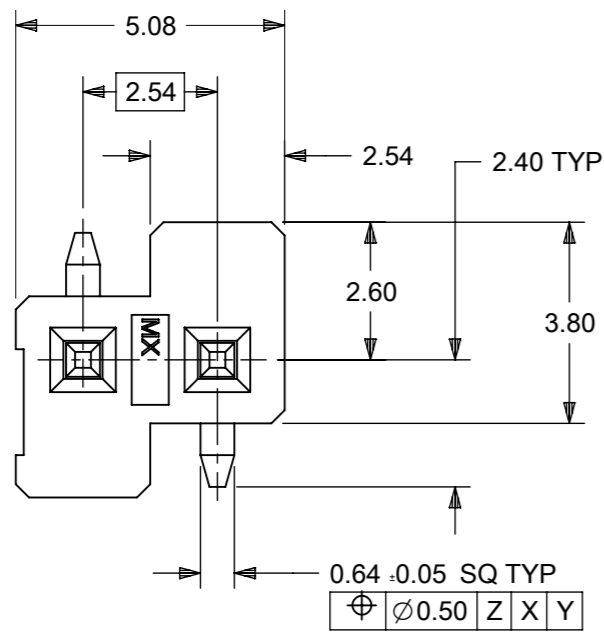

CONN WITH CAP

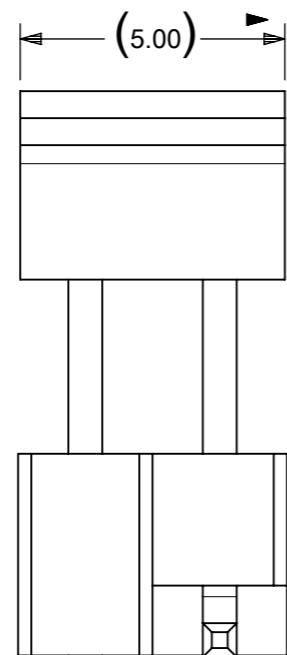

CONN WITH CAP

PACKAGING OPTION PART NO.						CKT SIZE	PLATING TYPE	DIMENSION		
TRAY WITHOUT CAP	TRAY WITH CAP	TUBE WITHOUT CAP	TUBE WITH CAP	TAPE & REEL WITHOUT CAP	TAPE & REEL WITH CAP			G	F	M
-----	-----	-----	-----	-----	87898-0218	2	4	10.69	9.65	5.84
-----	-----	-----	-----	-----	87898-0219	2	6	10.69	9.65	5.84
-----	-----	-----	87898-0220	-----	-----	2	6	10.64	9.60	5.84
-----	-----	-----	-----	-----	87898-0221	2	6	24.53	23.49	19.73

ONLY APPLICABLE TO 2CKT SIZE

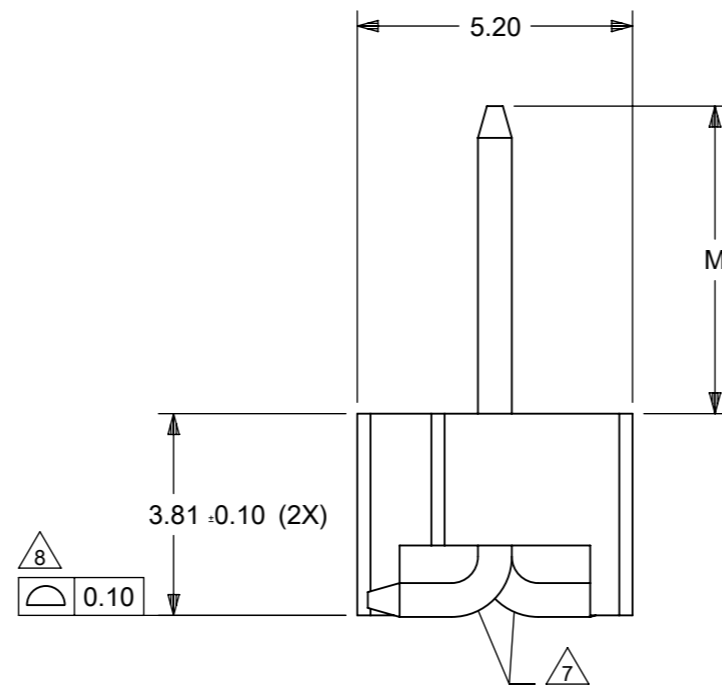

NOTES:

- MATERIAL:  
HSG: LCP, GLASS-FILLED, UL94V-0, COLOR: BLACK  
CAP: NYLON, GLASS-FILLED, UL94V-0, COLOR: BLACK  
PIN: 0.64MM SQ, COPPER ALLOY
- PLATING TYPE:  
(1) GOLD FLASH OVER  
1.25µm MIN. NICKEL OVERALL.  
(2) GOLD FLASH ON CONTACT AND  
2.50µm MIN. TIN ON SOLDER TAIL OVER  
1.25µm MIN. NICKEL OVERALL.  
(4) 0.38µm MIN. GOLD PLATE ON CONTACT AND  
2.00µm MIN. TIN ON SOLDER TAIL OVER  
1.25µm MIN. NICKEL OVERALL.  
(5) 0.75µm MIN. GOLD PLATE ON CONTACT AND  
2.00µm MIN. TIN ON SOLDER TAIL OVER  
1.25µm MIN. NICKEL OVERALL.  
(6) 2.50µm MIN. TIN OVERALL  
1.25µm MIN. NICKEL OVERALL
- PRODUCT SPECIFICATION: PS-87920-019
- PACKAGING TYPE: SEE TABLE
- PACKAGING SPEC:  
TUBE WITH CAP VERSION: PK-89990-558  
TUBE W/O CAP VERSION: PK-89990-545  
EMBOSS TAPE WITH CAP: PK-87898-400
- WAFER TO BE FLAT WITHIN 0.003 mm/mm
- BEND DEPRESSION IS ACCEPTED SO LONG AS IT DOES NOT AFFECT THE OVERALL COPLANARITY OF TAIL
- COPLANARITY IS TO BE MEASURED BY RESTING THE SOLDER TAIL ON A FLAT SURFACE
- CAP LOCATION IS CENTERED ALONG THE MATING ENDS AS SHOWN. TOP SURFACE OF CAP TO BE FLAT FOR THE PURPOSE OF PICK & PLACE BY VACUUM SUCTION NOZZLE
- RECOMMENDED PCB THICKNESS IS 1.60mm±0.10

THIS DRAWING CONTAINS INFORMATION THAT IS PROPRIETARY TO MOLEX ELECTRONIC TECHNOLOGIES, LLC AND SHOULD NOT BE USED WITHOUT WRITTEN PERMISSION											
DIMENSION UNITS		SCALE		CURRENT REV DESC: BRIGHT TIN PHASE OUT							
mm		NTS									
GENERAL TOLERANCES (UNLESS SPECIFIED)				EC NO: 679909		DRWN: AKUMAR19		2021/06/29		CUSTOM HEADER	
				CHK'D: MRAMAKRISHNA		APPR: MRAMAKRISHNA		2021/10/11		2.54MM PITCH SINGLE ROW SINGLE WAFER SMT HEADER	
				INITIAL REVISION:		DRWN: GGUNAGI		2016/11/09		PRODUCT CUSTOMER DRAWING	
				ANGULAR TOL ± 3.0°		APPR: ISHWARG		2016/12/06		DOCUMENT NUMBER	
DRAFT WHERE APPLICABLE MUST REMAIN WITHIN DIMENSIONS				THIRD ANGLE PROJECTION		DRAWING		SERIES		MATERIAL NUMBER	
						A3-SIZE		87898		CUSTOMER	
						SEE TABLE		GENERAL MARKET		SHEET NUMBER	
										21 OF 21	

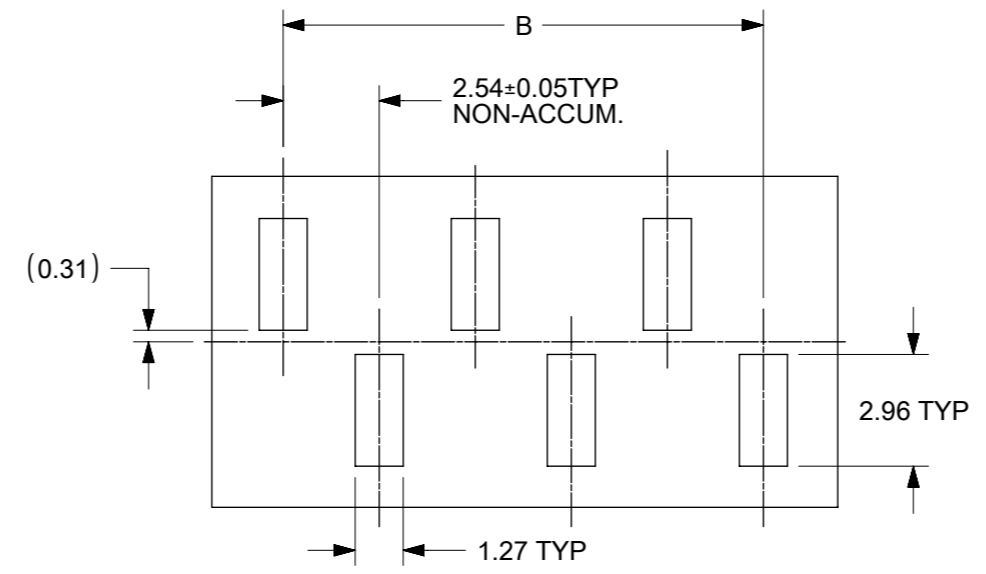
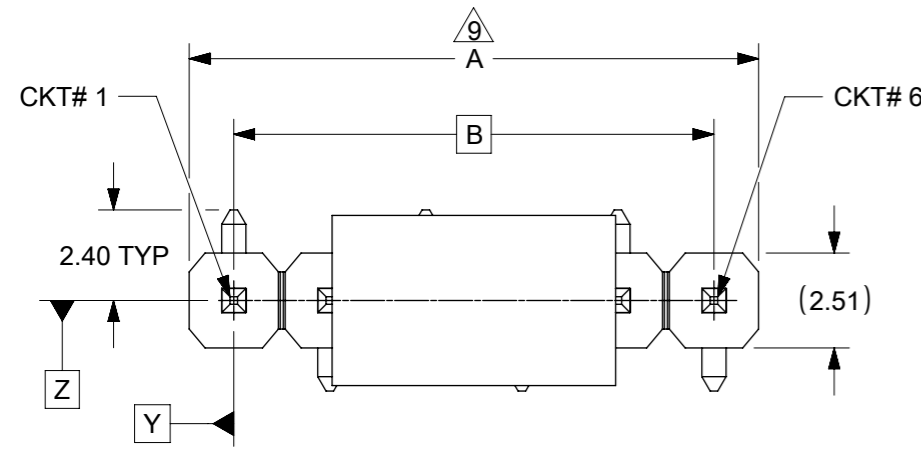

**RECOMMENDED PCB LAYOUT**

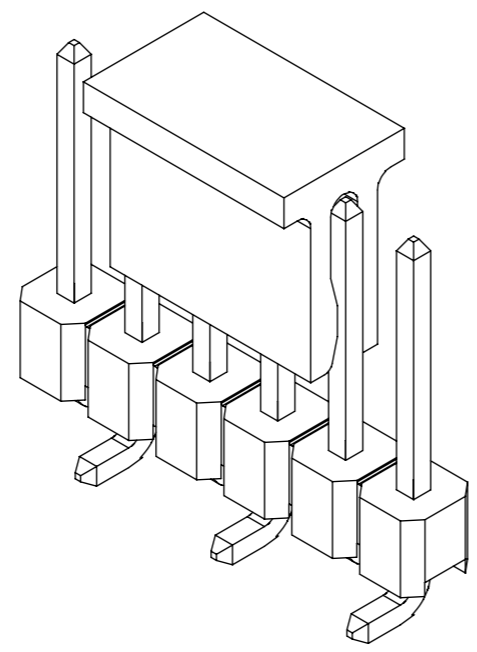
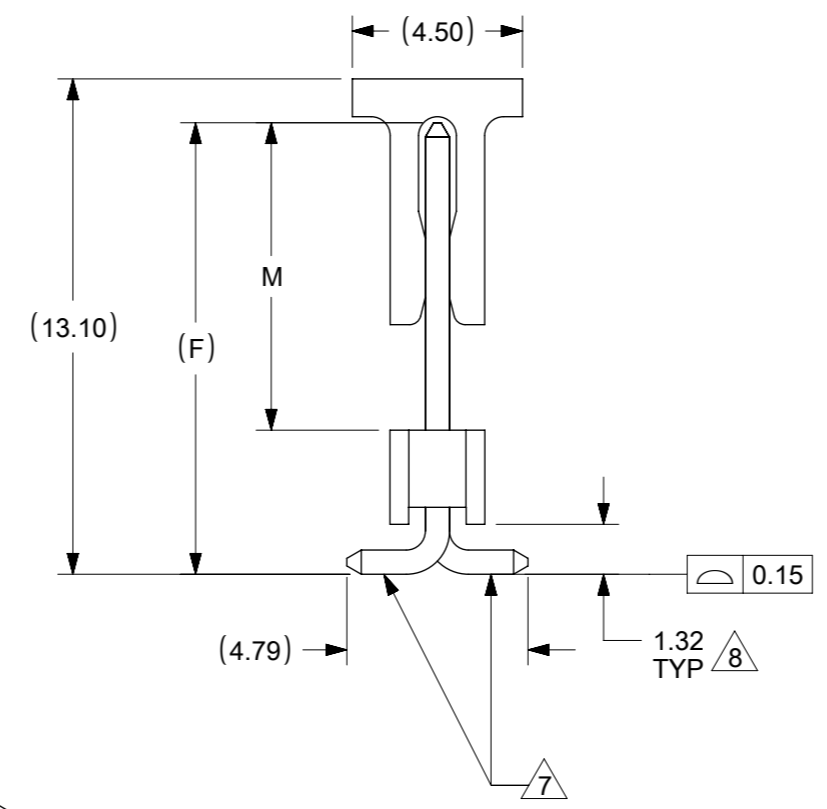
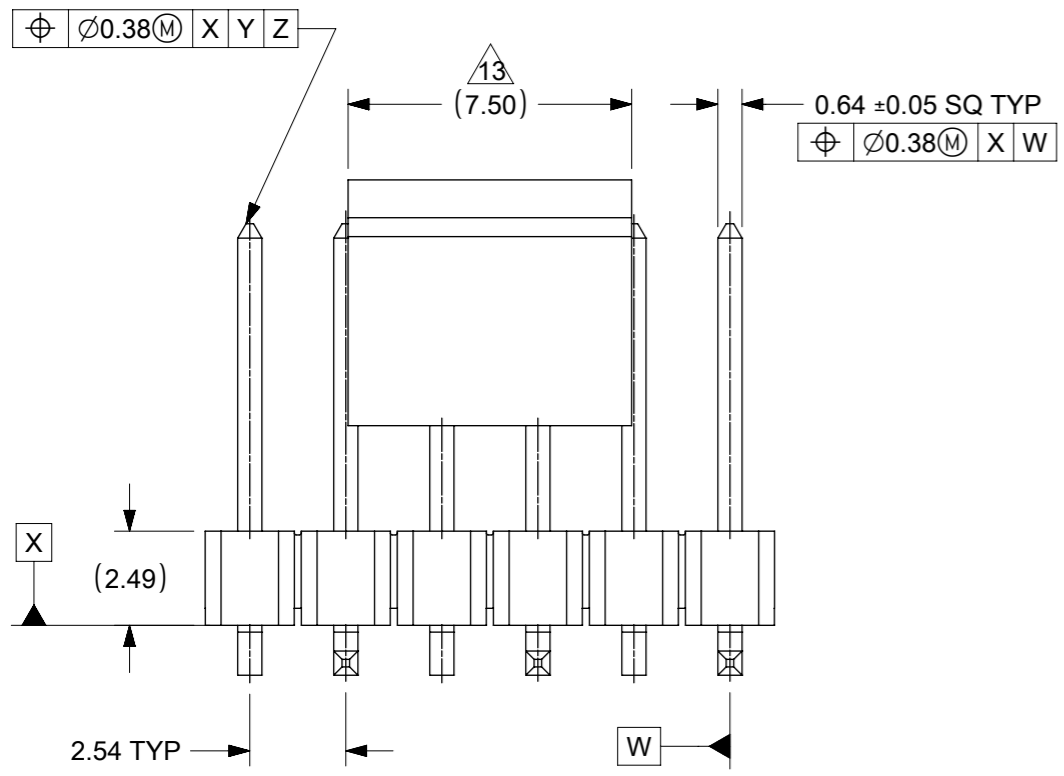

**NOTES:**

1. MATERIAL:  
HSG: NYLON, GLASS-FILLED, UL94V-0, COLOR: BLACK  
PIN: 0.64MM SQ, COPPER ALLOY
2. PLATING TYPE:
  - (1) GOLD FLASH OVER  
1.25µm MIN. NICKEL OVERALL.
  - (2) GOLD FLASH ON CONTACT AND  
2.50µm MIN. TIN ON SOLDER TAIL OVER  
1.25µm MIN. NICKEL OVERALL.
  - (4) 0.38µm MIN. GOLD PLATE ON CONTACT AND  
2.00µm MIN. TIN ON SOLDER TAIL OVER  
1.25µm MIN. NICKEL OVERALL.
  - (5) 0.75µm MIN. GOLD PLATE ON CONTACT AND  
2.00µm MIN. TIN ON SOLDER TAIL OVER  
1.25µm MIN. NICKEL OVERALL.
  - (6) 2.50µm MIN. TIN OVERALL  
1.25µm MIN. NICKEL OVERALL
3. PRODUCT SPECIFICATION: PS-87920-019
4. PACKAGING TYPE: SEE TABLE
5. PACKAGING SPEC: PK-89990-545(TUBE), PK-89990-486(T&R) & PK-87898-400 (T&R)
6. WAFER TO BE FLAT WITHIN 0.003 mm/mm
7. BEND DEPRESSION IS ACCEPTED SO LONG AS IT DOES NOT AFFECT THE OVERALL COPLANARITY OF TAIL
8. COPLANARITY IS TO BE MEASURED BY RESTING THE SOLDER TAIL ON A FLAT SURFACE
9. IRREGULAR CIRCUIT CUTOFF WITHIN BREAKAWAY SECTION IS PERMISSIBLE. CUTTING OR CHIPPING OF THE MAIN BODY IS NOT ACCEPTABLE
10. TUBE LENGTH AS PER STANDARD 560mm
11. RECOMMENDED PCB THICKNESS IS 1.60mm±0.10
12. THE ABOVE CKT 6 IS FOR ILLUSTRATION PURPOSE ONLY
13. CAP LOCATION IS CENTERED ALONG THE MATING ENDS AS SHOWN. TOP SURFACE OF CAP TO BE FLAT FOR THE PURPOSE OF PICK & PLACE BY VACUUM SUCTION NOZZLE.

THIS DRAWING CONTAINS INFORMATION THAT IS PROPRIETARY TO MOLEX ELECTRONIC TECHNOLOGIES, LLC AND SHOULD NOT BE USED WITHOUT WRITTEN PERMISSION		CURRENT REV DESC:		<b>molex</b>	
DIMENSION UNITS: mm		SCALE: NTS			
GENERAL TOLERANCES (UNLESS SPECIFIED)				PRODUCT CUSTOMER DRAWING	
				DOCUMENT NUMBER: SD-87898-003	
4 PLACES ±		MM INCH		DOC TYPE: PSD	
3 PLACES ±				DOC PART: 001	
2 PLACES ± 0.2				REVISION: C1	
1 PLACE ±					
0 PLACES ±					
ANGULAR TOL ± 3.0°					
DRAFT WHERE APPLICABLE MUST REMAIN WITHIN DIMENSIONS		THIRD ANGLE PROJECTION		SHEET NUMBER: 1 OF 17	
		DRAWING: A3-SIZE		SERIES: 87898	
		MATERIAL NUMBER: SEE TABLE		CUSTOMER: GENERAL MARKET	

9 8 7 6 5 4 3 2 1

E  
D  
C  
B  
A

PART WITHOUT CAP  
IN TUBE  
ORIENTATION

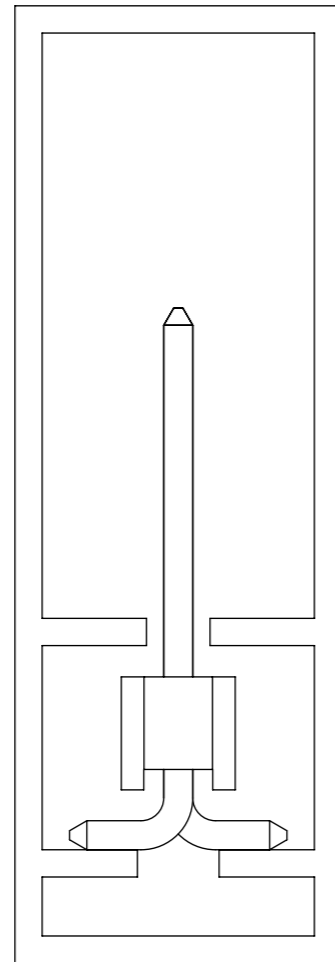

PART WITH CAP  
IN TUBE  
ORIENTATION

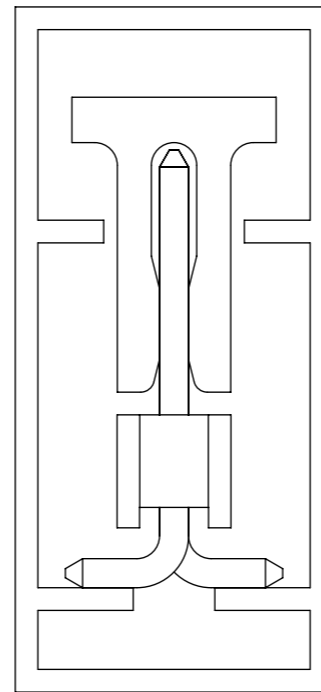

THIS DRAWING CONTAINS INFORMATION THAT IS PROPRIETARY TO MOLEX ELECTRONIC TECHNOLOGIES, LLC AND SHOULD NOT BE USED WITHOUT WRITTEN PERMISSION									
DIMENSION UNITS		SCALE		CURRENT REV DESC:				<b>molex</b>	
mm		NTS							
GENERAL TOLERANCES (UNLESS SPECIFIED)				EC NO: 698212 DRWN: DANUSA 2022/03/03 CHK'D: DANUSA 2022/03/04 APPR: MRAMAKRISHNA 2022/03/04				CUSTOM HEADER 2.54MM PITCH SINGLE ROW SINGLE WAFER SMT HEADER	
		MM	INCH						
4 PLACES		±	±	INITIAL REVISION: DRWN: SKLIM01 2005/10/26 APPR: PTLIM 2005/11/07				DOCUMENT NUMBER	
3 PLACES		±	±					SD-87898-003	
2 PLACES		± 0.2	±	PRODUCT CUSTOMER DRAWING				PSD 001 C1	
1 PLACE		±	±					MATERIAL NUMBER	
0 PLACES		±	±	SEE TABLE		GENERAL MARKET		2 OF 17	
ANGULAR TOL ± 3.0°				DRAFT WHERE APPLICABLE MUST REMAIN WITHIN DIMENSIONS		THIRD ANGLE PROJECTION		DRAWING	
						A3-SIZE		SERIES 87898	

DOCUMENT STATUS	P1	RELEASE DATE	2022/03/04	09:00:56
-----------------	----	--------------	------------	----------

9 8 7 6 5 4 3 2 1

FORMAT: Mef-lega-master-ib-prod-A3  
REVISION: D  
DATE: 2018/01/18

CKT	DIMENSION						QTY/REEL
	Bo	Ao	Ko	F	So	W	
3	8.02	5.20	13.60	11.50	--	24.00	320
4	10.51	5.79	15.05	14.20	28.40	32.00	250
5	13.10	5.20	13.60	11.50	---	24.00	320

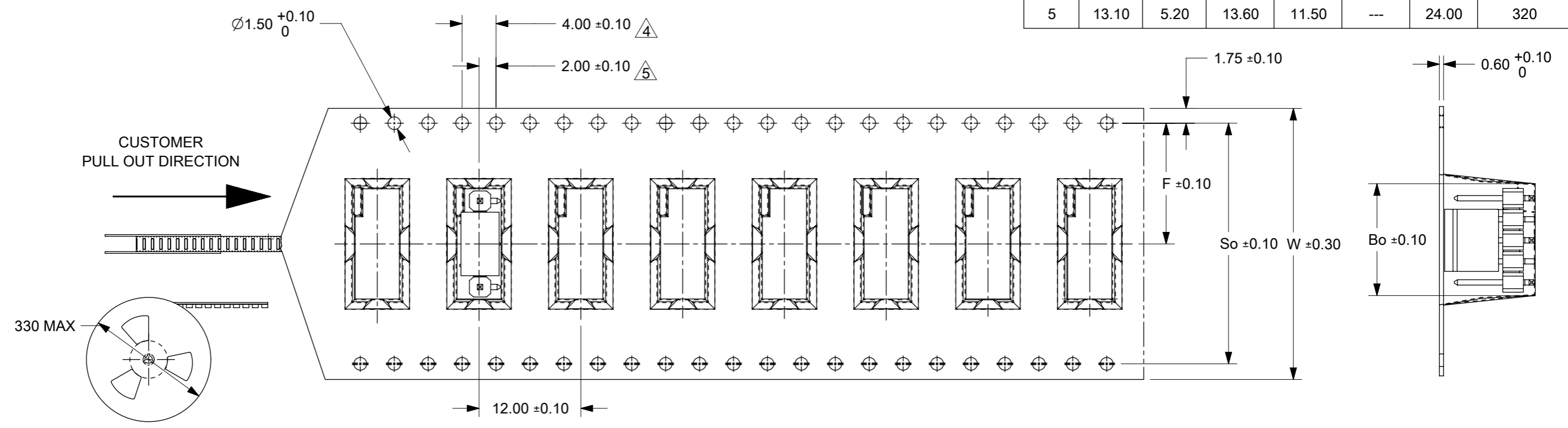

NOTES:

1. LEADER AND TRAILER TAPE

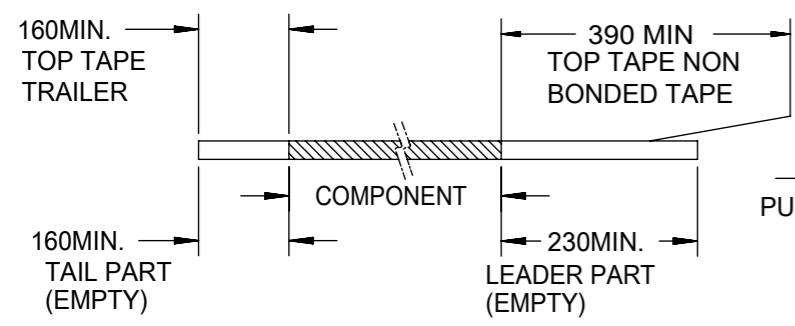

2. PEELING OFF FORCE OF THE TOP TAPE: 20 - 80gf. (PEELING DIRECTION AS SHOWN IN FOLLOWING FIGURE)

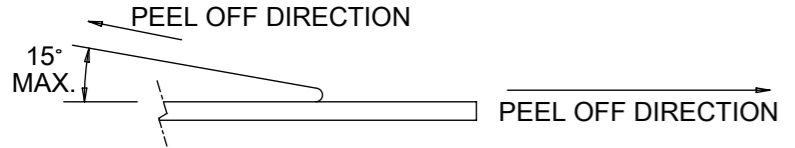

- 3. MATERIAL: BLACK P.S CONDUCTIVE, BLACK
- 4. MEASURED FROM CENTRELINE OF SPROCKET HOLE TO CENTRELINE OF POCKET
- 5. CUMULATIVE TOLERANCE OF 10 SPROCKET HOLE IS ±0.20mm
- 6. A0 AND B0 ARE MEASURE FROM ABOVE POCKET BASE 0.30mm
- 7. TAPE AND REEL SPECIFICATION IS AS PER EIA-481.
- 8. THE TAPE IS TREATED FOR ANTI-STATIC.
- 9. ALL RADIUS ARE 0.30MM UNLESS SPECIFY
- 10. SURFACE RESISTIVITY 10^3 TO 10 OHMS.

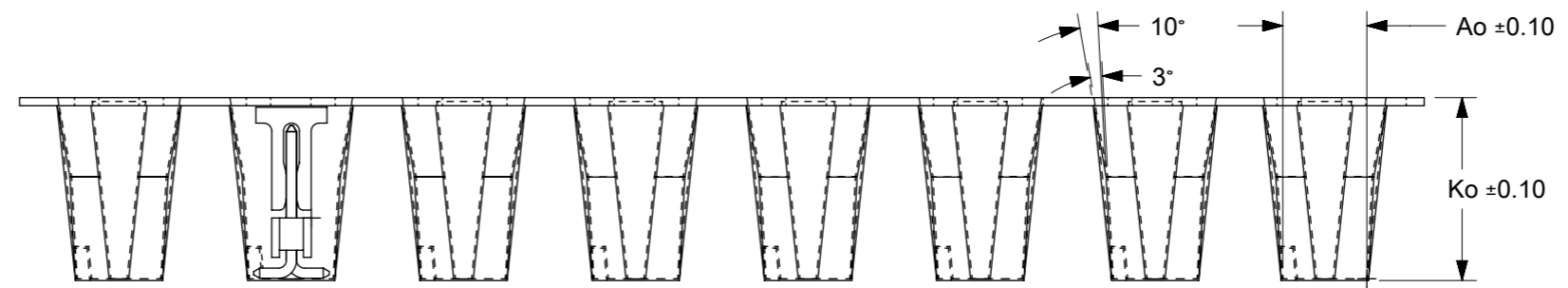

PART PACK IN E/TAPE ORIENTATION (FOR REF USE)

THIS DRAWING CONTAINS INFORMATION THAT IS PROPRIETARY TO MOLEX ELECTRONIC TECHNOLOGIES, LLC AND SHOULD NOT BE USED WITHOUT WRITTEN PERMISSION

DIMENSION UNITS	SCALE	CURRENT REV DESC:		<b>molex</b>		
mm	NTS					
GENERAL TOLERANCES (UNLESS SPECIFIED)		EC NO: 698212		CUSTOMER		
		DRWN: DANUSA 2022/03/03		2.54MM PITCH SINGLE ROW SINGLE WAFER SMT HEADER		
		CHK'D: DANUSA 2022/03/04		PRODUCT CUSTOMER DRAWING		
		APPR: MRAMAKRISHNA 2022/03/04		DOCUMENT NUMBER		
		INITIAL REVISION:		SD-87898-003		
		DRWN: SKLIM01 2005/10/26		DOC TYPE		
		APPR: PTLIM 2005/11/07		PSD		
		ANGULAR TOL ± 3.0°		DOC PART		
		DRAFT WHERE APPLICABLE MUST REMAIN WITHIN DIMENSIONS		001		
		THIRD ANGLE PROJECTION		REVISION		
		DRAWING		C1		
		SERIES		SHEET NUMBER		
		A3-SIZE 87898		3 OF 17		
		MATERIAL NUMBER		CUSTOMER		
		SEE TABLE		GENERAL MARKET		



9 8 7 6 5 4 3 2 1

PACKAGING OPTION PART NO.						CKT SIZE	VOID POSITION	PLATING TYPE	DIMENSION			
TRAY WITHOUT CAP	TRAY WITH CAP	TUBE WITHOUT CAP	TUBE WITH CAP	TAPE & REEL WITHOUT CAP	TAPE & REEL WITH CAP				A	B	F	M
-----	(C) 87898-0361	-----	-----	-----	-----	3	----	1	7.62	5.08	11.94	8.13
-----	(C) 87898-0362	-----	-----	-----	-----	3	----	2	7.62	5.08	11.94	8.13
-----	(C) 87898-0364	-----	-----	-----	87898-0369	3	----	4	7.62	5.08	11.94	8.13
-----	(C) 87898-0365	-----	-----	-----	-----	3	----	5	7.62	5.08	11.94	8.13
-----	(C) 87898-0366	-----	87898-0367	-----	87898-0368	3	----	6	7.62	5.08	11.94	8.13

E

E

D

D

C

C

B

B

A

A

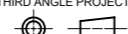
THIS DRAWING CONTAINS INFORMATION THAT IS PROPRIETARY TO MOLEX ELECTRONIC TECHNOLOGIES, LLC AND SHOULD NOT BE USED WITHOUT WRITTEN PERMISSION																	
DIMENSION UNITS		SCALE		CURRENT REV DESC:													
mm		NTS															
GENERAL TOLERANCES (UNLESS SPECIFIED)				EC NO: 698212 DRWN: DANUSA 2022/03/03 CHK'D: DANUSA 2022/03/04 APPR: MRAMAKRISHNA 2022/03/04 INITIAL REVISION: DRWN: SKLIM01 2005/10/26 APPR: PTLIM 2005/11/07						CUSTOM HEADER							
										2.54MM PITCH SINGLE ROW SINGLE WAFER SMT HEADER							
										PRODUCT CUSTOMER DRAWING							
										DOCUMENT NUMBER		DOC TYPE		DOC PART		REVISION	
										SD-87898-003		PSD		001		C1	
DRAFT WHERE APPLICABLE MUST REMAIN WITHIN DIMENSIONS				THIRD ANGLE PROJECTION		DRAWING		SERIES		MATERIAL NUMBER		CUSTOMER		SHEET NUMBER			
						A3-SIZE		87898		SEE TABLE		GENERAL MARKET		4 OF 17			

DOCUMENT STATUS	P1	RELEASE DATE	2022/03/04	09:00:56
-----------------	----	--------------	------------	----------

9 8 7 6 5 4 3 2 1

FORMAT: Mel-lega-master-ib-prod-A3  
 REVISION: D  
 DATE: 2018/01/18

PACKAGING OPTION PART NO.						CKT SIZE	PEG	VOID POSITION	PLATING TYPE	DIMENSION			
TRAY WITHOUT CAP	TRAY WITH CAP	TUBE WITHOUT CAP	TUBE WITH CAP	TAPE & REEL WITHOUT CAP	TAPE & REEL WITH CAP					A	B	F	M
-----	-----	87898-0461	-----	-----	-----	4	---	----	1	10.16	7.62	11.94	8.13
-----	-----	87898-0462	-----	-----	-----	4	---	----	2	10.16	7.62	11.94	8.13
-----	-----	87898-0464	-----	-----	-----	4	---	----	4	10.16	7.62	11.94	8.13
-----	-----	87898-0465	-----	-----	-----	4	---	----	5	10.16	7.62	11.94	8.13
-----	-----	87898-0466	-----	-----	87898-0467	4	---	----	6	10.16	7.62	11.94	8.13
-----	-----	-----	-----	-----	87898-0468	4	Y	----	6	10.16	7.62	11.94	8.13
-----	-----	-----	-----	87898-0489	-----	4	Y	----	5	10.16	7.62	16.74	12.93
-----	-----	87898-0561	-----	-----	-----	5	---	----	1	12.70	10.16	11.94	8.13
-----	-----	87898-0562	-----	-----	-----	5	---	----	2	12.70	10.16	11.94	8.13
-----	-----	87898-0564	-----	-----	-----	5	---	----	4	12.70	10.16	11.94	8.13
-----	-----	87898-0565	-----	-----	-----	5	---	----	5	12.70	10.16	11.94	8.13
-----	-----	87898-0566	87898-0567	-----	87898-0568	5	---	----	6	12.70	10.16	11.94	8.13
-----	-----	87898-0661	-----	-----	-----	6	---	----	1	15.24	12.70	11.94	8.13
-----	-----	87898-0662	-----	-----	-----	6	---	----	2	15.24	12.70	11.94	8.13
-----	-----	87898-0664	-----	-----	-----	6	---	----	4	15.24	12.70	11.94	8.13
-----	-----	87898-0665	-----	-----	(C) -----	6	---	----	5	15.24	12.70	11.94	8.13
-----	-----	87898-0666	-----	-----	87898-0605	6	---	----	6	15.24	12.70	11.94	8.13

4 CKT WITH PEG FOR ILLUSTRATION ONLY

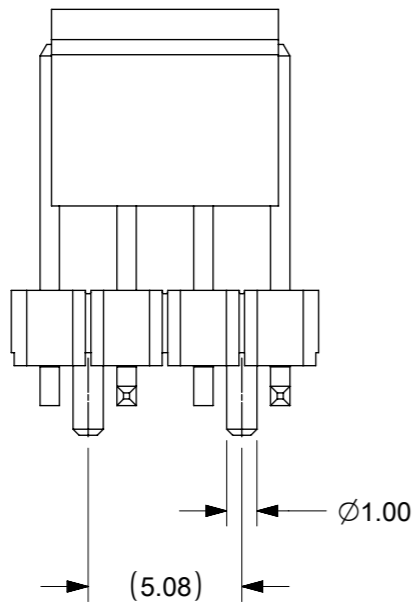

THIS DRAWING CONTAINS INFORMATION THAT IS PROPRIETARY TO MOLEX ELECTRONIC TECHNOLOGIES, LLC AND SHOULD NOT BE USED WITHOUT WRITTEN PERMISSION											
DIMENSION UNITS		SCALE		CURRENT REV DESC:							
mm		NTS									
GENERAL TOLERANCES (UNLESS SPECIFIED)				EC NO: 698212		DRWN: DANUSA		2022/03/03		CUSTOM HEADER	
				DRWN: DANUSA		CHK'D: DANUSA		2022/03/04		2.54MM PITCH SINGLE ROW SINGLE WAFER SMT HEADER	
				APPR: MRAMAKRISHNA		2022/03/04				PRODUCT CUSTOMER DRAWING	
4 PLACES ±				INITIAL REVISION:		DRWN: SKLIM01		2005/10/26		DOCUMENT NUMBER	
3 PLACES ±				APPR: PTLIM		2005/11/07		SD-87898-003		DOC TYPE DOC PART REVISION	
2 PLACES ± 0.2										PSD 001 C1	
1 PLACE ±											
0 PLACES ±											
ANGULAR TOL ± 3.0°				THIRD ANGLE PROJECTION		DRAWING		SERIES		MATERIAL NUMBER	
DRAFT WHERE APPLICABLE MUST REMAIN WITHIN DIMENSIONS						A3-SIZE		87898		CUSTOMER	
								SEE TABLE		GENERAL MARKET	
										SHEET NUMBER	
										5 OF 17	

PACKAGING OPTION PART NO.						CKT SIZE	VOID POSITION	PLATING TYPE	DIMENSION			
TRAY WITHOUT CAP	TRAY WITH CAP	TUBE WITHOUT CAP	TUBE WITH CAP	TAPE & REEL WITHOUT CAP	TAPE & REEL WITH CAP				A	B	F	M
-----	-----	87898-0761	-----	-----	-----	7	----	1	17.78	15.24	11.94	8.13
-----	-----	87898-0762	-----	-----	-----	7	----	2	17.78	15.24	11.94	8.13
-----	-----	87898-0764	-----	-----	-----	7	----	4	17.78	15.24	11.94	8.13
-----	-----	87898-0765	-----	-----	-----	7	----	5	17.78	15.24	11.94	8.13
-----	-----	87898-0766	-----	-----	-----	7	----	6	17.78	15.24	11.94	8.13
-----	-----	87898-0861	-----	-----	-----	8	----	1	20.32	17.78	11.94	8.13
-----	-----	87898-0862	-----	-----	-----	8	----	2	20.32	17.78	11.94	8.13
-----	-----	87898-0864	-----	-----	-----	8	----	4	20.32	17.78	11.94	8.13
-----	-----	87898-0865	-----	-----	-----	8	----	5	20.32	17.78	11.94	8.13
-----	-----	87898-0866	-----	-----	-----	8	----	6	20.32	17.78	11.94	8.13
-----	-----	87898-0961	-----	-----	-----	9	----	1	22.86	20.32	11.94	8.13
-----	-----	87898-0962	-----	-----	-----	9	----	2	22.86	20.32	11.94	8.13
-----	-----	87898-0964	-----	-----	-----	9	----	4	22.86	20.32	11.94	8.13
-----	-----	87898-0965	-----	-----	-----	9	----	5	22.86	20.32	11.94	8.13
-----	-----	87898-0966	-----	-----	-----	9	----	6	22.86	20.32	11.94	8.13

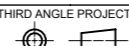
THIS DRAWING CONTAINS INFORMATION THAT IS PROPRIETARY TO MOLEX ELECTRONIC TECHNOLOGIES, LLC AND SHOULD NOT BE USED WITHOUT WRITTEN PERMISSION											
DIMENSION UNITS		SCALE		CURRENT REV DESC:							
mm		NTS									
GENERAL TOLERANCES (UNLESS SPECIFIED)				EC NO: 698212 DRWN: DANUSA 2022/03/03 CHK'D: DANUSA 2022/03/04 APPR: MRAMAKRISHNA 2022/03/04						CUSTOM HEADER 2.54MM PITCH SINGLE ROW SINGLE WAFER SMT HEADER	
4 PLACES		±	±	INITIAL REVISION: DRWN: SKLIM01 2005/10/26 APPR: PTLIM 2005/11/07						PRODUCT CUSTOMER DRAWING	
3 PLACES		±	±								
2 PLACES		± 0.2	±	DOCUMENT NUMBER <b>SD-87898-003</b>						DOC TYPE PSD	
1 PLACE		±	±								
0 PLACES		±	±	MATERIAL NUMBER SEE TABLE						DOC PART 001	
ANGULAR TOL		± 3.0°									
DRAFT WHERE APPLICABLE MUST REMAIN WITHIN DIMENSIONS				THIRD ANGLE PROJECTION		DRAWING		SERIES		CUSTOMER	
						A3-SIZE		87898		GENERAL MARKET	
										SHEET NUMBER 6 OF 17	

PACKAGING OPTION PART NO.						CKT SIZE	VOID POSITION	PLATING TYPE	DIMENSION			
TRAY WITHOUT CAP	TRAY WITH CAP	TUBE WITHOUT CAP	TUBE WITH CAP	TAPE & REEL WITHOUT CAP	TAPE & REEL WITH CAP				A	B	F	M
-----	-----	87898-1061	-----	-----	-----	10	----	1	25.40	22.86	11.94	8.13
-----	-----	87898-1062	-----	-----	-----	10	----	2	25.40	22.86	11.94	8.13
-----	-----	87898-1064	-----	-----	-----	10	----	4	25.40	22.86	11.94	8.13
-----	-----	87898-1065	-----	-----	-----	10	----	5	25.40	22.86	11.94	8.13
-----	-----	87898-1066	-----	-----	-----	10	----	6	25.40	22.86	11.94	8.13
-----	-----	87898-1161	-----	-----	-----	11	----	1	27.94	25.40	11.94	8.13
-----	-----	87898-1162	-----	-----	-----	11	----	2	27.94	25.40	11.94	8.13
-----	-----	87898-1164	-----	-----	-----	11	----	4	27.94	25.40	11.94	8.13
-----	-----	87898-1165	-----	-----	-----	11	----	5	27.94	25.40	11.94	8.13
-----	-----	87898-1166	-----	-----	-----	11	----	6	27.94	25.40	11.94	8.13
-----	-----	87898-1261	-----	-----	-----	12	----	1	30.48	27.94	11.94	8.13
-----	-----	87898-1262	-----	-----	-----	12	----	2	30.48	27.94	11.94	8.13
-----	-----	87898-1264	-----	-----	-----	12	----	4	30.48	27.94	11.94	8.13
-----	-----	87898-1265	-----	-----	-----	12	----	5	30.48	27.94	11.94	8.13
-----	-----	87898-1266	-----	-----	-----	12	----	6	30.48	27.94	11.94	8.13

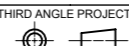
THIS DRAWING CONTAINS INFORMATION THAT IS PROPRIETARY TO MOLEX ELECTRONIC TECHNOLOGIES, LLC AND SHOULD NOT BE USED WITHOUT WRITTEN PERMISSION											
DIMENSION UNITS		SCALE		CURRENT REV DESC:							
mm		NTS		EC NO: 698212							
GENERAL TOLERANCES (UNLESS SPECIFIED)				DRWN: DANUSA		2022/03/03		CUSTOM HEADER 2.54MM PITCH SINGLE ROW SINGLE WAFER SMT HEADER			
				CHK'D: DANUSA		2022/03/04					
				APPR: MRAMAKRISHNA		2022/03/04		PRODUCT CUSTOMER DRAWING			
				INITIAL REVISION:				DOCUMENT NUMBER		DOC TYPE   DOC PART   REVISION	
				DRWN: SKLIM01		2005/10/26		SD-87898-003		PSD   001   C1	
				APPR: PTLIM		2005/11/07		MATERIAL NUMBER		CUSTOMER	
DRAFT WHERE APPLICABLE MUST REMAIN WITHIN DIMENSIONS				THIRD ANGLE PROJECTION		DRAWING		SERIES		SHEET NUMBER	
						A3-SIZE		87898		7 OF 17	

PACKAGING OPTION PART NO.						CKT SIZE	VOID POSITION	PLATING TYPE	DIMENSION			
TRAY WITHOUT CAP	TRAY WITH CAP	TUBE WITHOUT CAP	TUBE WITH CAP	TAPE & REEL WITHOUT CAP	TAPE & REEL WITH CAP				A	B	F	M
-----	-----	87898-1361	-----	-----	-----	13	----	1	33.02	30.48	11.94	8.13
-----	-----	87898-1362	-----	-----	-----	13	----	2	33.02	30.48	11.94	8.13
-----	-----	87898-1364	-----	-----	-----	13	----	4	33.02	30.48	11.94	8.13
-----	-----	87898-1365	-----	-----	-----	13	----	5	33.02	30.48	11.94	8.13
-----	-----	87898-1366	-----	-----	-----	13	----	6	33.02	30.48	11.94	8.13
-----	-----	87898-1461	-----	-----	-----	14	----	1	35.56	33.02	11.94	8.13
-----	-----	87898-1462	-----	-----	-----	14	----	2	35.56	33.02	11.94	8.13
-----	-----	87898-1464	-----	-----	-----	14	----	4	35.56	33.02	11.94	8.13
-----	-----	87898-1465	-----	-----	-----	14	----	5	35.56	33.02	11.94	8.13
-----	-----	87898-1466	-----	-----	-----	14	----	6	35.56	33.02	11.94	8.13
-----	-----	87898-1561	-----	-----	-----	15	----	1	38.10	35.56	11.94	8.13
-----	-----	87898-1562	-----	-----	-----	15	----	2	38.10	35.56	11.94	8.13
-----	-----	87898-1564	-----	-----	-----	15	----	4	38.10	35.56	11.94	8.13
-----	-----	87898-1565	-----	-----	-----	15	----	5	38.10	35.56	11.94	8.13
-----	-----	87898-1566	-----	-----	-----	15	----	6	38.10	35.56	11.94	8.13

THIS DRAWING CONTAINS INFORMATION THAT IS PROPRIETARY TO MOLEX ELECTRONIC TECHNOLOGIES, LLC AND SHOULD NOT BE USED WITHOUT WRITTEN PERMISSION												
DIMENSION UNITS		SCALE		CURRENT REV DESC:								
mm		NTS										
GENERAL TOLERANCES (UNLESS SPECIFIED)				EC NO: 698212 DRWN: DANUSA 2022/03/03 CHK'D: DANUSA 2022/03/04 APPR: MRAMAKRISHNA 2022/03/04				CUSTOM HEADER 2.54MM PITCH SINGLE ROW SINGLE WAFER SMT HEADER				
		MM	INCH									
4 PLACES		±	±	INITIAL REVISION: DRWN: SKLIM01 2005/10/26 APPR: PTLIM 2005/11/07				DOCUMENT NUMBER		DOC TYPE	DOC PART	REVISION
3 PLACES		±	±					SD-87898-003		PSD	001	C1
2 PLACES		±	0.2 ±	DRAFT WHERE APPLICABLE MUST REMAIN WITHIN DIMENSIONS				MATERIAL NUMBER		CUSTOMER		SHEET NUMBER
1 PLACE		±	±					SEE TABLE		GENERAL MARKET		8 OF 17
0 PLACES		±	±	THIRD ANGLE PROJECTION		DRAWING	SERIES	A3-SIZE		87898		
ANGULAR TOL		± 3.0°										

PACKAGING OPTION PART NO.						CKT SIZE	VOID POSITION	PLATING TYPE	DIMENSION			
TRAY WITHOUT CAP	TRAY WITH CAP	TUBE WITHOUT CAP	TUBE WITH CAP	TAPE & REEL WITHOUT CAP	TAPE & REEL WITH CAP				A	B	F	M
-----	-----	87898-1661	-----	-----	-----	16	----	1	40.64	38.10	11.94	8.13
-----	-----	87898-1662	-----	-----	-----	16	----	2	40.64	38.10	11.94	8.13
-----	-----	87898-1664	-----	-----	-----	16	----	4	40.64	38.10	11.94	8.13
-----	-----	87898-1665	-----	-----	-----	16	----	5	40.64	38.10	11.94	8.13
-----	-----	87898-1666	-----	-----	-----	16	----	6	40.64	38.10	11.94	8.13
-----	-----	87898-1761	-----	-----	-----	17	----	1	43.18	40.64	11.94	8.13
-----	-----	87898-1762	-----	-----	-----	17	----	2	43.18	40.64	11.94	8.13
-----	-----	87898-1764	-----	-----	-----	17	----	4	43.18	40.64	11.94	8.13
-----	-----	87898-1765	-----	-----	-----	17	----	5	43.18	40.64	11.94	8.13
-----	-----	87898-1766	-----	-----	-----	17	----	6	43.18	40.64	11.94	8.13
-----	-----	87898-1861	-----	-----	-----	18	----	1	45.72	43.18	11.94	8.13
-----	-----	87898-1862	-----	-----	-----	18	----	2	45.72	43.18	11.94	8.13
-----	-----	87898-1864	-----	-----	-----	18	----	4	45.72	43.18	11.94	8.13
-----	-----	87898-1865	-----	-----	-----	18	----	5	45.72	43.18	11.94	8.13
-----	-----	87898-1866	-----	-----	-----	18	----	6	45.72	43.18	11.94	8.13

THIS DRAWING CONTAINS INFORMATION THAT IS PROPRIETARY TO MOLEX ELECTRONIC TECHNOLOGIES, LLC AND SHOULD NOT BE USED WITHOUT WRITTEN PERMISSION												
DIMENSION UNITS		SCALE		CURRENT REV DESC:								
mm		NTS										
GENERAL TOLERANCES (UNLESS SPECIFIED)				EC NO: 698212 DRWN: DANUSA 2022/03/03 CHK'D: DANUSA 2022/03/04 APPR: MRAMAKRISHNA 2022/03/04				CUSTOM HEADER 2.54MM PITCH SINGLE ROW SINGLE WAFER SMT HEADER				
		MM	INCH									
4 PLACES	±		±	INITIAL REVISION: DRWN: SKLIM01 2005/10/26 APPR: PTLIM 2005/11/07				DOCUMENT NUMBER		DOC TYPE	DOC PART	REVISION
3 PLACES	±		±					SD-87898-003		PSD	001	C1
2 PLACES	±	0.2	±	DRAFT WHERE APPLICABLE MUST REMAIN WITHIN DIMENSIONS				MATERIAL NUMBER		CUSTOMER		SHEET NUMBER
1 PLACE	±		±					SEE TABLE		GENERAL MARKET		9 OF 17
0 PLACES	±		±	THIRD ANGLE PROJECTION		DRAWING	SERIES	A3-SIZE		87898		
ANGULAR TOL		± 3.0°		DRAWING		SERIES		MATERIAL NUMBER		CUSTOMER		

PACKAGING OPTION PART NO.						CKT SIZE	VOID POSITION	PLATING TYPE	DIMENSION			
TRAY WITHOUT CAP	TRAY WITH CAP	TUBE WITHOUT CAP	TUBE WITH CAP	TAPE & REEL WITHOUT CAP	TAPE & REEL WITH CAP				A	B	F	M
-----	-----	87898-1961	-----	-----	-----	19	----	1	48.26	45.72	11.94	8.13
-----	-----	87898-1962	-----	-----	-----	19	----	2	48.26	45.72	11.94	8.13
-----	-----	87898-1964	-----	-----	-----	19	----	4	48.26	45.72	11.94	8.13
-----	-----	87898-1965	-----	-----	-----	19	----	5	48.26	45.72	11.94	8.13
-----	-----	87898-1966	-----	-----	-----	19	----	6	48.26	45.72	11.94	8.13
-----	-----	87898-2061	-----	-----	-----	20	----	1	50.80	48.26	11.94	8.13
-----	-----	87898-2062	-----	-----	-----	20	----	2	50.80	48.26	11.94	8.13
-----	-----	87898-2064	-----	-----	-----	20	----	4	50.80	48.26	11.94	8.13
-----	-----	87898-2065	-----	-----	-----	20	----	5	50.80	48.26	11.94	8.13
-----	-----	87898-2066	-----	-----	-----	20	----	6	50.80	48.26	11.94	8.13
-----	-----	87898-2161	-----	-----	-----	21	----	1	53.34	50.80	11.94	8.13
-----	-----	87898-2162	-----	-----	-----	21	----	2	53.34	50.80	11.94	8.13
-----	-----	87898-2164	-----	-----	-----	21	----	4	53.34	50.80	11.94	8.13
-----	-----	87898-2165	-----	-----	-----	21	----	5	53.34	50.80	11.94	8.13
-----	-----	87898-2166	-----	-----	-----	21	----	6	53.34	50.80	11.94	8.13

THIS DRAWING CONTAINS INFORMATION THAT IS PROPRIETARY TO MOLEX ELECTRONIC TECHNOLOGIES, LLC AND SHOULD NOT BE USED WITHOUT WRITTEN PERMISSION											
DIMENSION UNITS		SCALE		CURRENT REV DESC:							
mm		NTS		EC NO: 698212							
GENERAL TOLERANCES (UNLESS SPECIFIED)				DRWN: DANUSA		2022/03/03		CUSTOM HEADER 2.54MM PITCH SINGLE ROW SINGLE WAFER SMT HEADER			
				CHK'D: DANUSA		2022/03/04					
				APPR: MRAMAKRISHNA		2022/03/04		PRODUCT CUSTOMER DRAWING			
				INITIAL REVISION:				DOCUMENT NUMBER		DOC TYPE	
				DRWN: SKLIM01		2005/10/26		SD-87898-003		PSD	
				APPR: PTLIM		2005/11/07		001		C1	
ANGULAR TOL ± 3.0°				DRAFT WHERE APPLICABLE MUST REMAIN WITHIN DIMENSIONS		THIRD ANGLE PROJECTION		DRAWING		SHEET NUMBER	
						A3-SIZE		87898		10 OF 17	

PACKAGING OPTION PART NO.						CKT SIZE	VOID POSITION	PLATING TYPE	DIMENSION			
TRAY WITHOUT CAP	TRAY WITH CAP	TUBE WITHOUT CAP	TUBE WITH CAP	TAPE & REEL WITHOUT CAP	TAPE & REEL WITH CAP				A	B	F	M
-----	-----	87898-2261	-----	-----	-----	22	----	1	55.88	53.34	11.94	8.13
-----	-----	87898-2262	-----	-----	-----	22	----	2	55.88	53.34	11.94	8.13
-----	-----	87898-2264	-----	-----	-----	22	----	4	55.88	53.34	11.94	8.13
-----	-----	87898-2265	-----	-----	-----	22	----	5	55.88	53.34	11.94	8.13
-----	-----	87898-2266	-----	-----	-----	22	----	6	55.88	53.34	11.94	8.13
-----	-----	87898-2361	-----	-----	-----	23	----	1	58.42	55.88	11.94	8.13
-----	-----	87898-2362	-----	-----	-----	23	----	2	58.42	55.88	11.94	8.13
-----	-----	87898-2364	-----	-----	-----	23	----	4	58.42	55.88	11.94	8.13
-----	-----	87898-2365	-----	-----	-----	23	----	5	58.42	55.88	11.94	8.13
-----	-----	87898-2366	-----	-----	-----	23	----	6	58.42	55.88	11.94	8.13
-----	-----	87898-2461	-----	-----	-----	24	----	1	60.96	58.42	11.94	8.13
-----	-----	87898-2462	-----	-----	-----	24	----	2	60.96	58.42	11.94	8.13
-----	-----	87898-2464	-----	-----	-----	24	----	4	60.96	58.42	11.94	8.13
-----	-----	87898-2465	-----	-----	-----	24	----	5	60.96	58.42	11.94	8.13
-----	-----	87898-2466	-----	-----	-----	24	----	6	60.96	58.42	11.94	8.13

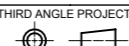
THIS DRAWING CONTAINS INFORMATION THAT IS PROPRIETARY TO MOLEX ELECTRONIC TECHNOLOGIES, LLC AND SHOULD NOT BE USED WITHOUT WRITTEN PERMISSION												
DIMENSION UNITS		SCALE		CURRENT REV DESC:								
mm		NTS		EC NO: 698212								
GENERAL TOLERANCES (UNLESS SPECIFIED)				DRWN: DANUSA		2022/03/03		CUSTOM HEADER 2.54MM PITCH SINGLE ROW SINGLE WAFER SMT HEADER				
				CHK'D: DANUSA		2022/03/04						
				APPR: MRAMAKRISHNA		2022/03/04		PRODUCT CUSTOMER DRAWING				
				INITIAL REVISION:				DOCUMENT NUMBER		DOC TYPE	DOC PART	REVISION
4 PLACES ±				DRWN: SKLIM01		2005/10/26		SD-87898-003		PSD	001	C1
3 PLACES ±				APPR: PTLIM		2005/11/07						
2 PLACES ± 0.2												
1 PLACE ±												
0 PLACES ±												
ANGULAR TOL ± 3.0°				THIRD ANGLE PROJECTION		DRAWING		SERIES		MATERIAL NUMBER		CUSTOMER
DRAFT WHERE APPLICABLE MUST REMAIN WITHIN DIMENSIONS						A3-SIZE		87898		SEE TABLE		GENERAL MARKET
												SHEET NUMBER
												11 OF 17

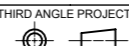

PACKAGING OPTION PART NO.						CKT SIZE	VOID POSITION	PLATING TYPE	DIMENSION			
TRAY WITHOUT CAP	TRAY WITH CAP	TUBE WITHOUT CAP	TUBE WITH CAP	TAPE & REEL WITHOUT CAP	TAPE & REEL WITH CAP				A	B	F	M
-----	-----	87898-2561	-----	-----	-----	25	----	1	63.50	60.96	11.94	8.13
-----	-----	87898-2562	-----	-----	-----	25	----	2	63.50	60.96	11.94	8.13
-----	-----	87898-2564	-----	-----	-----	25	----	4	63.50	60.96	11.94	8.13
-----	-----	87898-2565	-----	-----	-----	25	----	5	63.50	60.96	11.94	8.13
-----	-----	87898-2566	-----	-----	-----	25	----	6	63.50	60.96	11.94	8.13
-----	-----	87898-2661	-----	-----	-----	26	----	1	66.04	63.50	11.94	8.13
-----	-----	87898-2662	-----	-----	-----	26	----	2	66.04	63.50	11.94	8.13
-----	-----	87898-2664	-----	-----	-----	26	----	4	66.04	63.50	11.94	8.13
-----	-----	87898-2665	-----	-----	-----	26	----	5	66.04	63.50	11.94	8.13
-----	-----	87898-2666	-----	-----	-----	26	----	6	66.04	63.50	11.94	8.13
-----	-----	87898-2761	-----	-----	-----	27	----	1	68.58	66.04	11.94	8.13
-----	-----	87898-2762	-----	-----	-----	27	----	2	68.58	66.04	11.94	8.13
-----	-----	87898-2764	-----	-----	-----	27	----	4	68.58	66.04	11.94	8.13
-----	-----	87898-2765	-----	-----	-----	27	----	5	68.58	66.04	11.94	8.13
-----	-----	87898-2766	-----	-----	-----	27	----	6	68.58	66.04	11.94	8.13

THIS DRAWING CONTAINS INFORMATION THAT IS PROPRIETARY TO MOLEX ELECTRONIC TECHNOLOGIES, LLC AND SHOULD NOT BE USED WITHOUT WRITTEN PERMISSION														
DIMENSION UNITS		SCALE		CURRENT REV DESC:										
mm		NTS												
GENERAL TOLERANCES (UNLESS SPECIFIED)				EC NO: 698212 DRWN: DANUSA 2022/03/03 CHK'D: DANUSA 2022/03/04 APPR: MRAMAKRISHNA 2022/03/04						CUSTOM HEADER 2.54MM PITCH SINGLE ROW SINGLE WAFER SMT HEADER				
		MM	INCH											
4 PLACES	±		±	INITIAL REVISION: DRWN: SKLIM01 2005/10/26 APPR: PTLIM 2005/11/07						DOCUMENT NUMBER		DOC TYPE	DOC PART	REVISION
3 PLACES	±		±							SD-87898-003		PSD	001	C1
2 PLACES	±	0.2	±	DRAFT WHERE APPLICABLE MUST REMAIN WITHIN DIMENSIONS						MATERIAL NUMBER		CUSTOMER		SHEET NUMBER
1 PLACE	±		±							SEE TABLE		GENERAL MARKET		12 OF 17
0 PLACES	±		±	THIRD ANGLE PROJECTION		DRAWING	SERIES	CUSTOMER		SHEET NUMBER				
ANGULAR TOL ± 3.0°				A3-SIZE	87898	GENERAL MARKET		12 OF 17						

PACKAGING OPTION PART NO.						CKT SIZE	VOID POSITION	PLATING TYPE	DIMENSION			
TRAY WITHOUT CAP	TRAY WITH CAP	TUBE WITHOUT CAP	TUBE WITH CAP	TAPE & REEL WITHOUT CAP	TAPE & REEL WITH CAP				A	B	F	M
-----	-----	87898-2861	-----	-----	-----	28	----	1	71.12	68.58	11.94	8.13
-----	-----	87898-2862	-----	-----	-----	28	----	2	71.12	68.58	11.94	8.13
-----	-----	87898-2864	-----	-----	-----	28	----	4	71.12	68.58	11.94	8.13
-----	-----	87898-2865	-----	-----	-----	28	----	5	71.12	68.58	11.94	8.13
-----	-----	87898-2866	-----	-----	-----	28	----	6	71.12	68.58	11.94	8.13
-----	-----	87898-2961	-----	-----	-----	29	----	1	73.66	71.12	11.94	8.13
-----	-----	87898-2962	-----	-----	-----	29	----	2	73.66	71.12	11.94	8.13
-----	-----	87898-2964	-----	-----	-----	29	----	4	73.66	71.12	11.94	8.13
-----	-----	87898-2965	-----	-----	-----	29	----	5	73.66	71.12	11.94	8.13
-----	-----	87898-2966	-----	-----	-----	29	----	6	73.66	71.12	11.94	8.13
-----	-----	87898-3061	-----	-----	-----	30	----	1	76.20	73.66	11.94	8.13
-----	-----	87898-3062	-----	-----	-----	30	----	2	76.20	73.66	11.94	8.13
-----	-----	87898-3064	-----	-----	-----	30	----	4	76.20	73.66	11.94	8.13
-----	-----	87898-3065	-----	-----	-----	30	----	5	76.20	73.66	11.94	8.13
-----	-----	87898-3066	-----	-----	-----	30	----	6	76.20	73.66	11.94	8.13

THIS DRAWING CONTAINS INFORMATION THAT IS PROPRIETARY TO MOLEX ELECTRONIC TECHNOLOGIES, LLC AND SHOULD NOT BE USED WITHOUT WRITTEN PERMISSION												
DIMENSION UNITS		SCALE		CURRENT REV DESC:								
mm		NTS										
GENERAL TOLERANCES (UNLESS SPECIFIED)				EC NO: 698212 DRWN: DANUSA 2022/03/03 CHK'D: DANUSA 2022/03/04 APPR: MRAMAKRISHNA 2022/03/04				CUSTOM HEADER 2.54MM PITCH SINGLE ROW SINGLE WAFER SMT HEADER				
		MM	INCH									
4 PLACES	±		±	INITIAL REVISION: DRWN: SKLIM01 2005/10/26 APPR: PTLIM 2005/11/07				DOCUMENT NUMBER		DOC TYPE	DOC PART	REVISION
3 PLACES	±		±					SD-87898-003		PSD	001	C1
2 PLACES	±	0.2	±	DRAFT WHERE APPLICABLE MUST REMAIN WITHIN DIMENSIONS				MATERIAL NUMBER		CUSTOMER		SHEET NUMBER
1 PLACE	±		±					SEE TABLE		GENERAL MARKET		13 OF 17
0 PLACES	±		±	THIRD ANGLE PROJECTION		DRAWING	SERIES	A3-SIZE		87898		
ANGULAR TOL		± 3.0°		DRAWING		SERIES		MATERIAL NUMBER		CUSTOMER		

PACKAGING OPTION PART NO.						CKT SIZE	VOID POSITION	PLATING TYPE	DIMENSION			
TRAY WITHOUT CAP	TRAY WITH CAP	TUBE WITHOUT CAP	TUBE WITH CAP	TAPE & REEL WITHOUT CAP	TAPE & REEL WITH CAP				A	B	F	M
-----	-----	87898-3161	-----	-----	-----	31	----	1	78.74	76.20	11.94	8.13
-----	-----	87898-3162	-----	-----	-----	31	----	2	78.74	76.20	11.94	8.13
-----	-----	87898-3164	-----	-----	-----	31	----	4	78.74	76.20	11.94	8.13
-----	-----	87898-3165	-----	-----	-----	31	----	5	78.74	76.20	11.94	8.13
-----	-----	87898-3166	-----	-----	-----	31	----	6	78.74	76.20	11.94	8.13
-----	-----	87898-3261	-----	-----	-----	32	----	1	81.28	78.74	11.94	8.13
-----	-----	87898-3262	-----	-----	-----	32	----	2	81.28	78.74	11.94	8.13
-----	-----	87898-3264	-----	-----	-----	32	----	4	81.28	78.74	11.94	8.13
-----	-----	87898-3265	-----	-----	-----	32	----	5	81.28	78.74	11.94	8.13
-----	-----	87898-3266	-----	-----	-----	32	----	6	81.28	78.74	11.94	8.13
-----	-----	87898-3361	-----	-----	-----	33	----	1	83.82	81.28	11.94	8.13
-----	-----	87898-3362	-----	-----	-----	33	----	2	83.82	81.28	11.94	8.13
-----	-----	87898-3364	-----	-----	-----	33	----	4	83.82	81.28	11.94	8.13
-----	-----	87898-3365	-----	-----	-----	33	----	5	83.82	81.28	11.94	8.13
-----	-----	87898-3366	-----	-----	-----	33	----	6	83.82	81.28	11.94	8.13

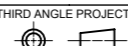
THIS DRAWING CONTAINS INFORMATION THAT IS PROPRIETARY TO MOLEX ELECTRONIC TECHNOLOGIES, LLC AND SHOULD NOT BE USED WITHOUT WRITTEN PERMISSION												
DIMENSION UNITS		SCALE		CURRENT REV DESC:								
mm		NTS										
GENERAL TOLERANCES (UNLESS SPECIFIED)				EC NO: 698212 DRWN: DANUSA 2022/03/03 CHK'D: DANUSA 2022/03/04 APPR: MRAMAKRISHNA 2022/03/04				CUSTOM HEADER 2.54MM PITCH SINGLE ROW SINGLE WAFER SMT HEADER				
		MM	INCH									
4 PLACES	±		±	INITIAL REVISION: DRWN: SKLIM01 2005/10/26 APPR: PTLIM 2005/11/07				DOCUMENT NUMBER		DOC TYPE	DOC PART	REVISION
3 PLACES	±		±					SD-87898-003		PSD	001	C1
2 PLACES	±	0.2	±	DRAFT WHERE APPLICABLE MUST REMAIN WITHIN DIMENSIONS				MATERIAL NUMBER		CUSTOMER		SHEET NUMBER
1 PLACE	±		±					SEE TABLE		GENERAL MARKET		14 OF 17
0 PLACES	±		±	THIRD ANGLE PROJECTION 		DRAWING		SERIES				
ANGULAR TOL ± 3.0°						A3-SIZE	87898					

PACKAGING OPTION PART NO.						CKT SIZE	VOID POSITION	PLATING TYPE	DIMENSION			
TRAY WITHOUT CAP	TRAY WITH CAP	TUBE WITHOUT CAP	TUBE WITH CAP	TAPE & REEL WITHOUT CAP	TAPE & REEL WITH CAP				A	B	F	M
-----	-----	87898-3461	-----	-----	-----	34	----	1	86.36	83.82	11.94	8.13
-----	-----	87898-3462	-----	-----	-----	34	----	2	86.36	83.82	11.94	8.13
-----	-----	87898-3464	-----	-----	-----	34	----	4	86.36	83.82	11.94	8.13
-----	-----	87898-3465	-----	-----	-----	34	----	5	86.36	83.82	11.94	8.13
-----	-----	87898-3466	-----	-----	-----	34	----	6	86.36	83.82	11.94	8.13
-----	-----	87898-3561	-----	-----	-----	35	----	1	88.90	86.36	11.94	8.13
-----	-----	87898-3562	-----	-----	-----	35	----	2	88.90	86.36	11.94	8.13
-----	-----	87898-3564	-----	-----	-----	35	----	4	88.90	86.36	11.94	8.13
-----	-----	87898-3565	-----	-----	-----	35	----	5	88.90	86.36	11.94	8.13
-----	-----	87898-3566	-----	-----	-----	35	----	6	88.90	86.36	11.94	8.13
-----	-----	87898-3661	-----	-----	-----	36	----	1	91.44	88.90	11.94	8.13
-----	-----	87898-3662	-----	-----	-----	36	----	2	91.44	88.90	11.94	8.13
-----	-----	87898-3664	-----	-----	-----	36	----	4	91.44	88.90	11.94	8.13
-----	-----	87898-3665	-----	-----	-----	36	----	5	91.44	88.90	11.94	8.13
-----	-----	87898-3666	-----	-----	-----	36	----	6	91.44	88.90	11.94	8.13

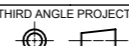
THIS DRAWING CONTAINS INFORMATION THAT IS PROPRIETARY TO MOLEX ELECTRONIC TECHNOLOGIES, LLC AND SHOULD NOT BE USED WITHOUT WRITTEN PERMISSION												
DIMENSION UNITS		SCALE		CURRENT REV DESC:								
mm		NTS										
GENERAL TOLERANCES (UNLESS SPECIFIED)				EC NO: 698212 DRWN: DANUSA 2022/03/03 CHK'D: DANUSA 2022/03/04 APPR: MRAMAKRISHNA 2022/03/04				CUSTOM HEADER 2.54MM PITCH SINGLE ROW SINGLE WAFER SMT HEADER				
		MM	INCH									
4 PLACES	±		±	INITIAL REVISION: DRWN: SKLIM01 2005/10/26 APPR: PTLIM 2005/11/07				DOCUMENT NUMBER		DOC TYPE	DOC PART	REVISION
3 PLACES	±		±					SD-87898-003		PSD	001	C1
2 PLACES	±	0.2	±	DRAFT WHERE APPLICABLE MUST REMAIN WITHIN DIMENSIONS				MATERIAL NUMBER		CUSTOMER		SHEET NUMBER
1 PLACE	±		±					SEE TABLE		GENERAL MARKET		15 OF 17
0 PLACES	±		±	THIRD ANGLE PROJECTION		DRAWING	SERIES	CUSTOMER		SHEET NUMBER		
ANGULAR TOL		± 3.0°				A3-SIZE	87898	GENERAL MARKET		15 OF 17		

PACKAGING OPTION PART NO.						CKT SIZE	VOID POSITION	PLATING TYPE	DIMENSION			
TRAY WITHOUT CAP	TRAY WITH CAP	TUBE WITHOUT CAP	TUBE WITH CAP	TAPE & REEL WITHOUT CAP	TAPE & REEL WITH CAP				A	B	F	M
-----	-----	87898-3761	-----	-----	-----	37	----	1	93.98	91.44	11.94	8.13
-----	-----	87898-3762	-----	-----	-----	37	----	2	93.98	91.44	11.94	8.13
-----	-----	87898-3764	-----	-----	-----	37	----	4	93.98	91.44	11.94	8.13
-----	-----	87898-3765	-----	-----	-----	37	----	5	93.98	91.44	11.94	8.13
-----	-----	87898-3766	-----	-----	-----	37	----	6	93.98	91.44	11.94	8.13
-----	-----	87898-3861	-----	-----	-----	38	----	1	96.52	93.98	11.94	8.13
-----	-----	87898-3862	-----	-----	-----	38	----	2	96.52	93.98	11.94	8.13
-----	-----	87898-3864	-----	-----	-----	38	----	4	96.52	93.98	11.94	8.13
-----	-----	87898-3865	-----	-----	-----	38	----	5	96.52	93.98	11.94	8.13
-----	-----	87898-3866	-----	-----	-----	38	----	6	96.52	93.98	11.94	8.13
-----	-----	87898-3961	-----	-----	-----	39	----	1	99.06	96.52	11.94	8.13
-----	-----	87898-3962	-----	-----	-----	39	----	2	99.06	96.52	11.94	8.13
-----	-----	87898-3964	-----	-----	-----	39	----	4	99.06	96.52	11.94	8.13
-----	-----	87898-3965	-----	-----	-----	39	----	5	99.06	96.52	11.94	8.13
-----	-----	87898-3966	-----	-----	-----	39	----	6	99.06	96.52	11.94	8.13

THIS DRAWING CONTAINS INFORMATION THAT IS PROPRIETARY TO MOLEX ELECTRONIC TECHNOLOGIES, LLC AND SHOULD NOT BE USED WITHOUT WRITTEN PERMISSION											
DIMENSION UNITS		SCALE		CURRENT REV DESC:				 CUSTOM HEADER 2.54MM PITCH SINGLE ROW SINGLE WAFER SMT HEADER			
mm		NTS		EC NO: 698212							
GENERAL TOLERANCES (UNLESS SPECIFIED)				DRWN: DANUSA 2022/03/03				PRODUCT CUSTOMER DRAWING DOCUMENT NUMBER: SD-87898-003   DOC TYPE: PSD   DOC PART: 001   REVISION: C1			
				CHK'D: DANUSA 2022/03/04							
				APPR: MRAMAKRISHNA 2022/03/04							
4 PLACES ±				INITIAL REVISION:							
3 PLACES ±				DRWN: SKLIM01 2005/10/26							
2 PLACES ± 0.2				APPR: PTLIM 2005/11/07							
1 PLACE ±				DRAFT WHERE APPLICABLE MUST REMAIN WITHIN DIMENSIONS							
0 PLACES ±				THIRD ANGLE PROJECTION							
ANGULAR TOL ± 3.0°				DRAWING							
				SERIES							
				MATERIAL NUMBER							
				CUSTOMER							
				SHEET NUMBER							

PACKAGING OPTION PART NO.						CKT SIZE	VOID POSITION	PLATING TYPE	DIMENSION			
TRAY WITHOUT CAP	TRAY WITH CAP	TUBE WITHOUT CAP	TUBE WITH CAP	TAPE & REEL WITHOUT CAP	TAPE & REEL WITH CAP				A	B	F	M
-----	-----	87898-4061	-----	-----	-----	40	----	1	101.6	99.06	11.94	8.13
-----	-----	87898-4062	-----	-----	-----	40	----	2	101.6	99.06	11.94	8.13
-----	-----	87898-4064	-----	-----	-----	40	----	4	101.6	99.06	11.94	8.13
-----	-----	87898-4065	-----	-----	-----	40	----	5	101.6	99.06	11.94	8.13
-----	-----	87898-4066	-----	-----	-----	40	----	6	101.6	99.06	11.94	8.13

E

E

D

D

C

C

B

B

A

A

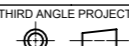
THIS DRAWING CONTAINS INFORMATION THAT IS PROPRIETARY TO MOLEX ELECTRONIC TECHNOLOGIES, LLC AND SHOULD NOT BE USED WITHOUT WRITTEN PERMISSION											
DIMENSION UNITS		SCALE		CURRENT REV DESC:							
mm		NTS									
GENERAL TOLERANCES (UNLESS SPECIFIED)				EC NO: 698212		DRWN: DANUSA		2022/03/03		CUSTOM HEADER 2.54MM PITCH SINGLE ROW SINGLE WAFER SMT HEADER	
				CHK'D: DANUSA		2022/03/04					
				APPR: MRAMAKRISHNA		2022/03/04		PRODUCT CUSTOMER DRAWING			
				INITIAL REVISION:		DRWN: SKLIM01		2005/10/26		DOCUMENT NUMBER	
				APPR: PTLIM		2005/11/07		SD-87898-003		DOC TYPE DOC PART REVISION	
				DRAFT WHERE APPLICABLE MUST REMAIN WITHIN DIMENSIONS		THIRD ANGLE PROJECTION		DRAWING		SHEET NUMBER	
						A3-SIZE		SERIES		GENERAL MARKET	
						87898		MATERIAL NUMBER		SEE TABLE	

DOCUMENT STATUS	P1	RELEASE DATE	2022/03/04	09:00:56
-----------------	----	--------------	------------	----------