

PV2 SERIES ANTI-VANDAL SWITCH

ANTI-VANDAL SWITCHES
DETECTOR SWITCHES
DIP SWITCHES
KEYLOCK SWITCHES
NAVIGATION SWITCHES
PUSHBUTTON SWITCHES
ROCKER SWITCHES
ROTARY SWITCHES
SLIDE SWITCHES
SNAP ACTION SWITCHES
TACTILE SWITCHES
TOGGLE SWITCHES
CAP OPTIONS



APPLICATIONS / MARKETS



SPECIFICATIONS

Electrical Rating: 2A, 48VDC
Mechanical Life: 1,000,000 Cycles
Electrical Life: 200,000 Cycles
Contact Resistance: 50mΩ Max.
Insulation Resistance: 1000 MΩ Min.
Dielectric Strength: 2,000VAC
Operating/Storage Temperature: -20°C to 55°C
Travel: 2.50mm
Moisture Protection: IP65
Contact Arrangement: SPST Off-(On)
Actuation Force: 4 N
Panel Thickness: 1-6mm
Mounting Nut Torque: 0.8Nm

FEATURES & BENEFITS

- 16mm panel cutout
- Solder or screw termination options
- Flat, high or domed actuator options
- IP65 rated

PART NUMBER CONFIGURATOR

Series	Actuator Options	Terminal Options	Function Options	Rating Options	Body Finish Options	Actuator Finish Options	Contact Material Options	Marking Options
<input type="text" value="PV2"/>	<input type="text" value="F"/> F - Flat <input type="text" value="H"/> H - High <input type="text" value="S"/> S - Domed	<input type="text" value="2"/> 2 - Solder <input type="text" value="6"/> 6 - Screw	<input type="text" value="4"/> 4 - Off - (On)*	<input type="text" value="0"/> 0 - 2A, 48VDC	<input type="text" value="G"/> G - Gold <input type="text" value="N"/> N - Nickel <input type="text" value="S"/> S - Polished Stainless <input type="text" value="B"/> B - Brushed Stainless <input type="text" value="1"/> 1 - Black Anod- ized	<input type="text" value="G"/> G - Gold <input type="text" value="N"/> N - Nickel <input type="text" value="S"/> S - Polished Stainless <input type="text" value="B"/> B - Brushed Stainless <input type="text" value="1"/> 1 - Black Anod- ized	<input type="text" value="NONE"/> NONE - Silver <input type="text" value="G"/> G - Gold	<input type="text" value="NONE"/> NONE - Non- Illuminated <input type="text" value="M01"/> M01 - Power Symbol

NOTES:
*(ON) Denotes function is momentary

Specifications subject to change without notice 6.10.2020



E-SWITCH®

www.e-switch.com

800.867.2717

1

PV2 SERIES ANTI-VANDAL SWITCH

SOLDER TERMINATION

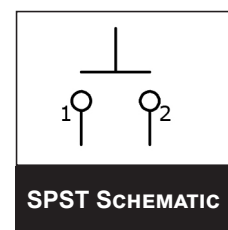
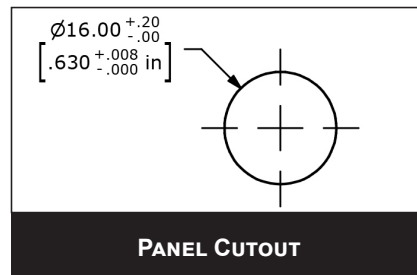
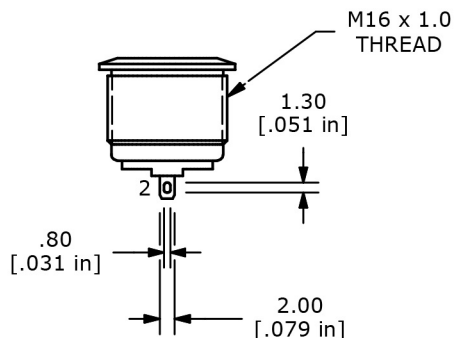
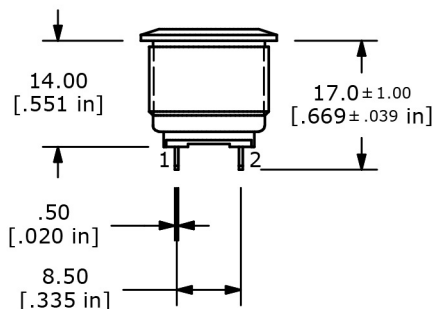
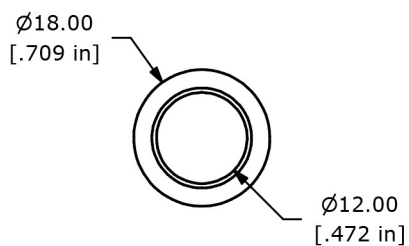

SCREW TERMINATION

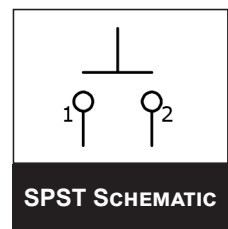
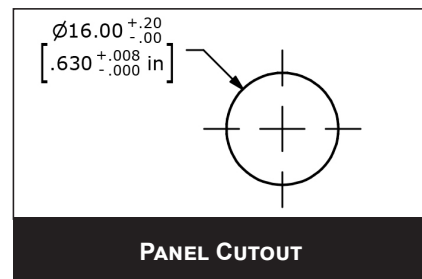
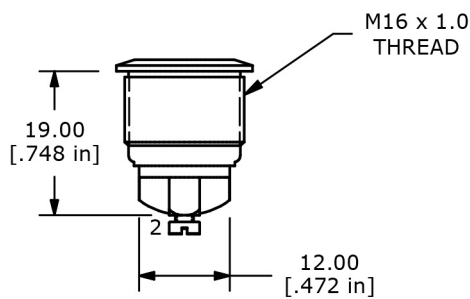
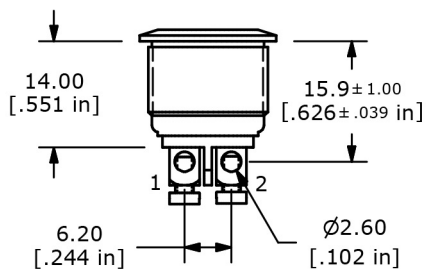
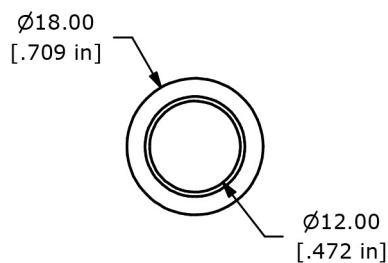

PV2 SERIES ANTI-VANDAL SWITCH

ACTUATOR OPTIONS

Ø18.00
[.709 in]

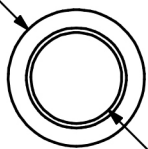

Ø12.00
[.472 in]

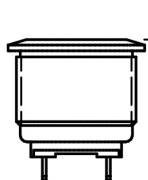

1.50
[.059 in]

FLAT ACTUATOR

Ø18.00
[.709 in]

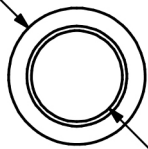

Ø12.00
[.472 in]



3.10
[.122 in]

HIGH ACTUATOR

Ø18.00
[.709 in]

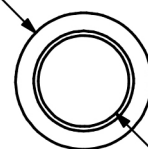

Ø12.00
[.472 in]

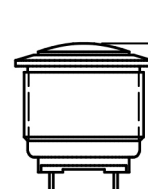

3.00
[.118 in]

DOMED ACTUATOR

GRAPHIC OPTIONS

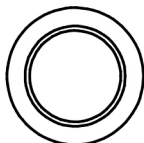

NONE

Ø6.00
[.236 in]

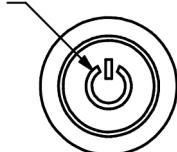

M01POWERSYMBOL

