

Operational Amplifier, Rail-to-Rail Output, 3 MHz BW

TLV271, TLV272, NCV272, TLV274, NCV274

The TLV/NCV27x operational amplifiers provide rail-to-rail output operation. The output can swing within 320 mV to the positive rail and 50 mV to the negative rail. This rail-to-rail operation enables the user to make optimal use of the entire supply voltage range while taking advantage of 3 MHz bandwidth. The opamp can operate on supply voltage as low as 2.7 V over the temperature range of -40°C to 125°C . The high bandwidth provides a slew rate of $2.4\text{ V}/\mu\text{s}$ while only consuming $550\ \mu\text{A}$ of quiescent current. Likewise the opamp can run on a supply voltage as high as 16 V (single) and 36 V (dual quad) making it ideal for a broad range of battery-operated applications. Since this is a CMOS device it has high input impedance and low bias currents making it ideal for interfacing to a wide variety of signal sensors. In addition it comes in a variety of compact packages with different pinout styles allowing for use in high-density PCB's.

Features

- Rail-To-Rail Output
- Wide Bandwidth: 3 MHz
- High Slew Rate: $2.4\text{ V}/\mu\text{s}$
- Wide Power-Supply Range: 2.7 V to 16 V (TLV271), 36 V (TLV/NCV272/274)
- Low Supply Current: $550\ \mu\text{A}$
- Low Input Bias Current: 45 pA
- Wide Temperature Range: -40°C to 125°C
- TSOP-5, Micro-8, SOIC-8, SOIC-14, TSSOP-14 Packages
- NCV Prefix for Automotive and Other Applications Requiring Unique Site and Control Change Requirements; AEC-Q100 Qualified and PPAP Capable
- These Devices are Pb-Free, Halogen Free/BFR Free and are RoHS Compliant

Applications

- Notebook Computers
- Portable Instruments
- Signal Conditioning
- Automotive
- Power Supplies
- Current Sensing



ON Semiconductor®

www.onsemi.com



TSOP-5
CASE 483



Micro8
CASE 846A



SOIC-8
CASE 751

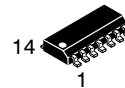

SOIC-14 NB
CASE 751A

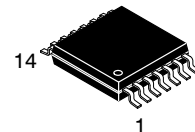

TSSOP-14
CASE 948G

DEVICE MARKING INFORMATION

See general marking information in the device marking section on page 2 of this data sheet.

ORDERING INFORMATION

See detailed ordering and shipping information on page 3 of this data sheet.

TLV271, TLV272, NCV272, TLV274, NCV274

MARKING DIAGRAMS

Single Channel Configuration TLV271

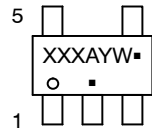

**TSOP-5
CASE 483**

XXX = ADG (TLV271SN1T1G)
 = ADH (TLV271SN2T1G)
 A = Assembly Location
 Y = Year
 W = Work Week
 ■ = Pb-Free Package
 (Note: Microdot may be in either location)

Dual Channel Configuration TLV272, NCV272

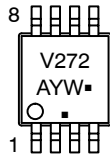

**Micro8
CASE 846A**

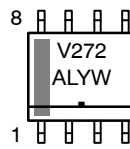

**SOIC-8
CASE 751**

Quad Channel Configuration TLV274, NCV274

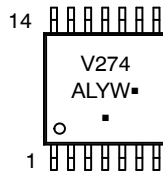

**TSSOP-14
CASE 948G**

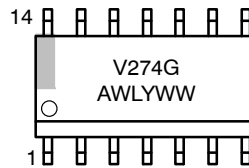

**SOIC-14 NB
CASE 751A**

XXXXX = Specific Device Code
 A = Assembly Location
 WL, L = Wafer Lot
 Y = Year
 WW, W = Work Week
 G or ■ = Pb-Free Package

(Note: Microdot may be in either location)

TLV271, TLV272, NCV272, TLV274, NCV274

PIN CONNECTIONS

Single Channel Configuration TLV271

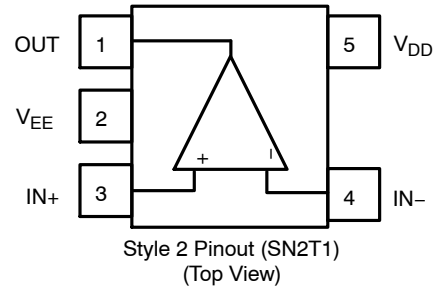
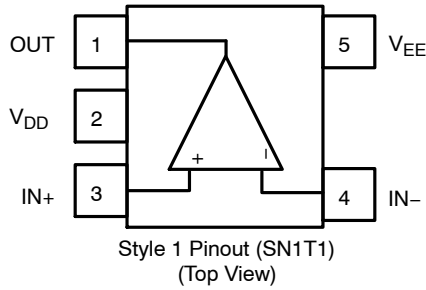

Dual Channel Configuration TLV272, NCV272

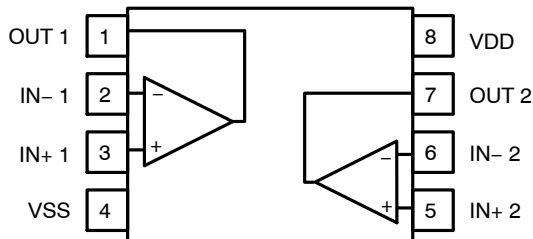

Quadruple Channel Configuration TLV274, NCV274

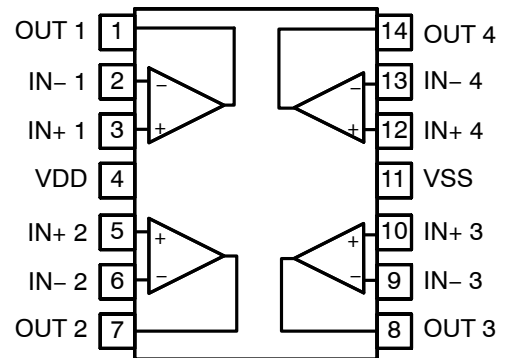

ORDERING INFORMATION

| Device | Configuration | Automotive | Marking | Package | Shipping† |
|----------------------------------|---------------|------------|---------|----------------|----------------------|
| TLV271SN1T1G (Style 1 Pinout) | Single | No | ADG | TSOP-5 | 3000 / Tape and Reel |
| TLV271SN2T1G (Style 2 Pinout) | | | ADH | | 3000 / Tape and Reel |
| TLV272DR2G | Dual | | V272 | SOIC-8 | 2500 / Tape and Reel |
| TLV272DMR2G | | | V272 | Micro-8/MSOP-8 | 4000 / Tape and Reel |
| TLV274DR2G | Quad | | V274 | SOIC-14 | 2500 / Tape and Reel |
| TLV274DTBR2G | | | V274 | TSSOP-14 | 2500 / Tape and Reel |
| NCV272DR2G* | Dual | Yes | V272 | SOIC-8 | 2500 / Tape and Reel |
| NCV272DMR2G* | | | V272 | Micro-8/MSOP-8 | 4000 / Tape and Reel |
| NCV274DR2G* | Quad | | V274 | SOIC-14 | 2500 / Tape and Reel |
| NCV274DTBR2G* | | | V274 | TSSOP-14 | 2500 / Tape and Reel |

†For information on tape and reel specifications, including part orientation and tape sizes, please refer to our Tape and Reel Packaging Specifications Brochure, BRD8011/D.

*NCV Prefix for Automotive and Other Applications Requiring Unique Site and Control Change Requirements; AEC-Q100 Qualified and PPAP Capable.

TLV271, TLV272, NCV272, TLV274, NCV274

MAXIMUM RATINGS

| Symbol | Rating | Value | Unit | |
|--------------------|--|-------------------------------------|------|----|
| V _{DD} | Supply Voltage (Note 1) | TLV271 | 16.5 | V |
| | | TLV/NCV272/274 | 36 | V |
| V _{ID} | Input Differential Voltage | ± Supply Voltage | V | |
| V _I | Input Common Mode Voltage Range (Note 1) | -0.2 V to (V _{DD} + 0.2 V) | V | |
| I _I | Maximum Input Current | ± 10 | mA | |
| I _O | Output Current Range | ± 100 | mA | |
| | Continuous Total Power Dissipation (Note 1) | 200 | mW | |
| T _J | Maximum Junction Temperature | 150 | °C | |
| T _A | Operating Ambient Temperature Range (free-air) | -40 to 125 | °C | |
| T _{STG} | Storage Temperature Range | -65 to 150 | °C | |
| ESD _{HBM} | ESD Capability, Human Body Model | 2 | kV | |
| ESD _{CDM} | ESD Capability, Charged Device Model | TLV271 | TBD | kV |
| | | TLV/NCV272 | 2 | kV |
| | | TLV/NCV274 | 1 | kV |
| | Mounting Temperature (Infrared or Convection – 20 sec) | 260 | °C | |

Stresses exceeding those listed in the Maximum Ratings table may damage the device. If any of these limits are exceeded, device functionality should not be assumed, damage may occur and reliability may be affected.

1. Continuous short-circuit operation to ground at elevated ambient temperature can result in exceeding the maximum allowed junction temperature of 150°C. Output currents in excess of 45 mA over long term may adversely affect reliability. Shorting output to either V+ or V- will adversely affect reliability.

THERMAL INFORMATION

| Parameter | Symbol | Package | Single Layer Board (Note 2) | Multi-Layer Board (Note 3) | Unit |
|---------------------|-----------------|------------------|-----------------------------|----------------------------|------|
| Junction-to-Ambient | θ _{JA} | TSOP-5 | 333 | 195 | °C/W |
| | | Micro-8 / MSOP-8 | 236 | 167 | |
| | | SOIC-8 | 190 | 131 | |
| | | SOIC-14 | 142 | 101 | |
| | | TSSOP-14 | 179 | 128 | |

2. Values based on a 1S standard PCB according to JEDEC51-3 with 1.0 oz copper and a 300 mm² copper area
3. Values based on a 1S2P standard PCB according to JEDEC51-7 with 1.0 oz copper and a 100 mm² copper area

TLV271, TLV272, NCV272, TLV274, NCV274

TLV271 DC ELECTRICAL CHARACTERISTICS

($V_{DD} = 2.7V, 3.3V, 5V$ & $\pm 5V$ (Note 4), $T_A = 25^\circ C$, $R_L \geq 10\text{ k}\Omega$ unless otherwise noted)

| Parameter | Symbol | Conditions | Min | Typ | Max | Unit | |
|---------------------------------------|------------|---|---------------------------|------|-----|------------------|----|
| Input Offset Voltage | V_{IO} | $V_{IC} = V_{DD}/2$, $V_O = V_{DD}/2$, $R_L = 10\text{ k}\Omega$, $R_S = 50\ \Omega$ | | 0.5 | 5 | mV | |
| | | $T_A = -40^\circ C$ to $+105^\circ C$ | | | 7 | | |
| Offset Voltage Drift | ICV_{OS} | $V_{IC} = V_{DD}/2$, $V_O = V_{DD}/2$, $R_L = 10\text{ k}\Omega$, $R_S = 50\ \Omega$ | | 2 | | $\mu V/^\circ C$ | |
| Common Mode Rejection Ratio | CMRR | $0\text{ V} \leq V_{IC} \leq V_{DD} - 1.35\text{ V}$, $R_S = 50\ \Omega$ | $V_{DD} = 2.7\text{ V}$ | 58 | 70 | dB | |
| | | $T_A = -40^\circ C$ to $+105^\circ C$ | | 55 | | | |
| | | $0\text{ V} \leq V_{IC} \leq V_{DD} - 1.35\text{ V}$, $R_S = 50\ \Omega$ | $V_{DD} = 5\text{ V}$ | 65 | 130 | | |
| | | $T_A = -40^\circ C$ to $+105^\circ C$ | | 62 | | | |
| | | $0\text{ V} \leq V_{IC} \leq V_{DD} - 1.35\text{ V}$, $R_S = 50\ \Omega$ | $V_{DD} = \pm 5\text{ V}$ | 69 | 140 | | |
| $T_A = -40^\circ C$ to $+105^\circ C$ | 66 | | | | | | |
| Power Supply Rejection Ratio | PSRR | $V_{DD} = 2.7\text{ V}$ to 16 V , $V_{IC} = V_{DD}/2$, No Load | | 70 | 135 | dB | |
| | | $T_A = -40^\circ C$ to $+105^\circ C$ | | 65 | | | |
| Large Signal Voltage Gain | A_{VD} | $V_{O(pp)} = V_{DD}/2$, $R_L = 10\text{ k}\Omega$ | $V_{DD} = 2.7\text{ V}$ | 97 | 106 | dB | |
| | | $T_A = -40^\circ C$ to $+105^\circ C$ | | 76 | | | |
| | | $V_{O(pp)} = V_{DD}/2$, $R_L = 10\text{ k}\Omega$ | $V_{DD} = 3.3\text{ V}$ | 97 | 123 | | |
| | | $T_A = -40^\circ C$ to $+105^\circ C$ | | 76 | | | |
| | | $V_{O(pp)} = V_{DD}/2$, $R_L = 10\text{ k}\Omega$ | $V_{DD} = 5\text{ V}$ | 100 | 127 | | |
| | | $T_A = -40^\circ C$ to $+105^\circ C$ | | 86 | | | |
| | | $V_{O(pp)} = V_{DD}/2$, $R_L = 10\text{ k}\Omega$ | $V_{DD} = \pm 5\text{ V}$ | 100 | 130 | | |
| $T_A = -40^\circ C$ to $+105^\circ C$ | 90 | | | | | | |
| Input Bias Current | I_B | $V_{DD} = 5\text{ V}$, $V_{IC} = V_{DD}/2$, $V_O = V_{DD}/2$, $R_S = 50\ \Omega$ | $T_A = 25^\circ C$ | | 45 | 150 | pA |
| | | | $T_A = 105^\circ C$ | | | 1000 | |
| Input Offset Current | I_{IO} | $V_{DD} = 5\text{ V}$, $V_{IC} = V_{DD}/2$, $V_O = V_{DD}/2$, $R_S = 50\ \Omega$ | $T_A = 25^\circ C$ | | 45 | 150 | pA |
| | | | $T_A = 105^\circ C$ | | | 1000 | |
| Differential Input Resistance | $r_{i(d)}$ | | | 1000 | | G Ω | |
| Common-mode Input Capacitance | C_{IC} | $f = 21\text{ kHz}$ | | 8 | | pF | |

4. $V_{DD} = \pm 5\text{ V}$ is shorthand for $V_{DD} = +5\text{ V}$ and $V_{EE} = -5\text{ V}$.

TLV271, TLV272, NCV272, TLV274, NCV274

TLV271 DC ELECTRICAL CHARACTERISTICS

($V_{DD} = 2.7V, 3.3V, 5V$ & $\pm 5V$ (Note 4), $T_A = 25^\circ C$, $R_L \geq 10\text{ k}\Omega$ unless otherwise noted)

| Parameter | Symbol | Conditions | Min | Typ | Max | Unit | | |
|------------------------------|----------|---|---------------------------|------|------|------|---|---|
| Output Swing (High-level) | V_{OH} | $V_{IC} = V_{DD}/2, I_{OH} = -1\text{ mA}$ | $V_{DD} = 2.7\text{ V}$ | 2.55 | 2.58 | | V | |
| | | $T_A = -40^\circ C$ to $+105^\circ C$ | | 2.48 | | | | |
| | | $V_{IC} = V_{DD}/2, I_{OH} = -1\text{ mA}$ | $V_{DD} = 3.3\text{ V}$ | 3.15 | 3.21 | | | |
| | | $T_A = -40^\circ C$ to $+105^\circ C$ | | 3.00 | | | | |
| | | $V_{IC} = V_{DD}/2, I_{OH} = -1\text{ mA}$ | $V_{DD} = 5\text{ V}$ | 4.8 | 4.93 | | | |
| | | $T_A = -40^\circ C$ to $+105^\circ C$ | | 4.75 | | | | |
| | | $V_{IC} = V_{DD}/2, I_{OH} = -1\text{ mA}$ | $V_{DD} = \pm 5\text{ V}$ | 4.92 | 4.96 | | | |
| | | $T_A = -40^\circ C$ to $+105^\circ C$ | | 4.9 | | | | |
| | | $V_{IC} = V_{DD}/2, I_{OH} = -5\text{ mA}$ | $V_{DD} = 2.7\text{ V}$ | 1.9 | 2.1 | | | V |
| | | $T_A = -40^\circ C$ to $+105^\circ C$ | | 1.5 | | | | |
| | | $V_{IC} = V_{DD}/2, I_{OH} = -5\text{ mA}$ | $V_{DD} = 3.3\text{ V}$ | 2.5 | 2.89 | | | |
| | | $T_A = -40^\circ C$ to $+105^\circ C$ | | 2.1 | | | | |
| | | $V_{IC} = V_{DD}/2, I_{OH} = -5\text{ mA}$ | $V_{DD} = 5\text{ V}$ | 4.5 | 4.68 | | | |
| | | $T_A = -40^\circ C$ to $+105^\circ C$ | | 4.35 | | | | |
| | | $V_{IC} = V_{DD}/2, I_{OH} = -5\text{ mA}$ | $V_{DD} = \pm 5\text{ V}$ | 4.7 | 4.78 | | | |
| | | $T_A = -40^\circ C$ to $+105^\circ C$ | | 4.65 | | | | |
| Output Swing (Low-level) | V_{OL} | $V_{IC} = V_{DD}/2, I_{OL} = -1\text{ mA}$ | $V_{DD} = 2.7\text{ V}$ | | 0.1 | 0.15 | V | |
| | | $T_A = -40^\circ C$ to $+105^\circ C$ | | | | 0.22 | | |
| | | $V_{IC} = V_{DD}/2, I_{OL} = -1\text{ mA}$ | $V_{DD} = 3.3\text{ V}$ | | 0.03 | 0.15 | | |
| | | $T_A = -40^\circ C$ to $+105^\circ C$ | | | | 0.22 | | |
| | | $V_{IC} = V_{DD}/2, I_{OL} = -1\text{ mA}$ | $V_{DD} = 5\text{ V}$ | | 0.03 | 0.1 | | |
| | | $T_A = -40^\circ C$ to $+105^\circ C$ | | | | 0.15 | | |
| | | $V_{IC} = V_{DD}/2, I_{OL} = -1\text{ mA}$ | $V_{DD} = \pm 5\text{ V}$ | | 0.05 | 0.08 | | |
| | | $T_A = -40^\circ C$ to $+105^\circ C$ | | | | 0.1 | | |
| | | $V_{IC} = V_{DD}/2, I_{OL} = -5\text{ mA}$ | $V_{DD} = 2.7\text{ V}$ | | 0.5 | 0.7 | | V |
| | | $T_A = -40^\circ C$ to $+105^\circ C$ | | | | 1.1 | | |
| | | $V_{IC} = V_{DD}/2, I_{OL} = -5\text{ mA}$ | $V_{DD} = 3.3\text{ V}$ | | 0.13 | 0.7 | | |
| | | $T_A = -40^\circ C$ to $+105^\circ C$ | | | | 1.1 | | |
| | | $V_{IC} = V_{DD}/2, I_{OL} = -5\text{ mA}$ | $V_{DD} = 5\text{ V}$ | | 0.13 | 0.4 | | |
| | | $T_A = -40^\circ C$ to $+105^\circ C$ | | | | 0.5 | | |
| | | $V_{IC} = V_{DD}/2, I_{OL} = -5\text{ mA}$ | $V_{DD} = \pm 5\text{ V}$ | | 0.16 | 0.3 | | |
| | | $T_A = -40^\circ C$ to $+105^\circ C$ | | | | 0.35 | | |
| Output Current | I_O | $V_O = 0.5\text{ V}$ from rail, $V_{DD} = 2.7\text{ V}$ | Positive rail | 4.0 | | mA | | |
| | | | Negative rail | 5.0 | | | | |
| | | $V_O = 0.5\text{ V}$ from rail, $V_{DD} = 5\text{ V}$ | Positive rail | 7.0 | | | | |
| | | | Negative rail | 8.0 | | | | |
| | | $V_O = 0.5\text{ V}$ from rail, $V_{DD} = 10\text{ V}$ | Positive rail | 13 | | | | |
| | | | Negative rail | 12 | | | | |

4. $V_{DD} = \pm 5\text{ V}$ is shorthand for $V_{DD} = +5\text{ V}$ and $V_{EE} = -5\text{ V}$.

TLV271, TLV272, NCV272, TLV274, NCV274

TLV271 DC ELECTRICAL CHARACTERISTICS

($V_{DD} = 2.7V, 3.3V, 5V$ & $\pm 5V$ (Note 4), $T_A = 25^\circ C$, $R_L \geq 10 k\Omega$ unless otherwise noted)

| Parameter | Symbol | Conditions | Min | Typ | Max | Unit | |
|--------------------------------|----------|---------------------------------------|------------------|-----|------|------|---------|
| Power Supply Quiescent Current | I_{DD} | $V_O = V_{DD}/2$ | $V_{DD} = 2.7 V$ | | 380 | 560 | μA |
| | | | $V_{DD} = 3.3 V$ | | 385 | 620 | |
| | | | $V_{DD} = 5 V$ | | 390 | 660 | |
| | | | $V_{DD} = 10 V$ | | 400 | 800 | |
| | | $T_A = -40^\circ C$ to $+105^\circ C$ | | | 1000 | | |

4. $V_{DD} = \pm 5 V$ is shorthand for $V_{DD} = +5 V$ and $V_{EE} = -5 V$.

TLV271 AC ELECTRICAL CHARACTERISTICS

($V_{DD} = 2.7 V, 5 V$, & $\pm 5 V$ (Note 5), $T_A = 25^\circ C$, and $R_L \geq 10 k\Omega$ unless otherwise noted)

| Parameter | Symbol | Conditions | Min | Typ | Max | Unit | |
|---------------------------------------|------------|--|--------------------------|---------------------------------------|----------------|-----------|-----|
| Unity Gain Bandwidth | UGBW | $R_L = 2 k\Omega, C_L = 10 pF$ | $V_{DD} = 2.7 V$ | | 3.2 | MHz | |
| | | | $V_{DD} = 5 V$ to $10 V$ | | 3.5 | | |
| Slew Rate at Unity Gain | SR | $V_{O(pp)} = V_{DD}/2, R_L = 10 k\Omega, C_L = 50 pF$ | $V_{DD} = 2.7 V$ | | 1.35 | $V/\mu S$ | |
| | | | | $T_A = -40^\circ C$ to $+105^\circ C$ | | | 1 |
| | | $V_{O(pp)} = V_{DD}/2, R_L = 10 k\Omega, C_L = 50 pF$ | $V_{DD} = 5 V$ | | 1.45 | | 2.3 |
| | | | | $T_A = -40^\circ C$ to $+105^\circ C$ | | | 1.2 |
| | | $V_{O(pp)} = V_{DD}/2, R_L = 10 k\Omega, C_L = 50 pF$ | $V_{DD} = \pm 5 V$ | | 1.8 | | 2.6 |
| $T_A = -40^\circ C$ to $+105^\circ C$ | | | | 1.3 | | | |
| Phase Margin | θ_m | $R_L = 2 k\Omega, C_L = 10 pF$ | | 45 | | $^\circ$ | |
| Gain Margin | | $R_L = 2 k\Omega, C_L = 10 pF$ | | 14 | | dB | |
| Settling Time to 0.1% | t_S | V -step(pp) = 1 V, AV = -1, $R_L = 2 k\Omega, C_L = 10 pF$ | $V_{DD} = 2.7 V$ | | 2.9 | μS | |
| | | | $V_{DD} = 5 V, \pm 5 V$ | | 2.0 | | |
| Total Harmonic Distortion plus Noise | THD+N | $V_{DD} = 2.7 V, V_{O(pp)} = V_{DD}/2, R_L = 2 k\Omega, f = 10 kHz$ | AV = 1 | | 0.004 | % | |
| | | | AV = 10 | | 0.04 | | |
| | | | AV = 100 | | 0.3 | | |
| | | $V_{DD} = 5 V, \pm 5 V, V_{O(pp)} = V_{DD}/2, R_L = 2 k\Omega, f = 10 kHz$ | AV = 1 | | 0.004 | | |
| | | | AV = 10 | | 0.04 | | |
| | | | AV = 100 | | 0.03 | | |
| Input-Referred Voltage Noise | e_n | f = 1 kHz | | 30 | nV/\sqrt{Hz} | | |
| | | f = 10 kHz | | 20 | | | |
| Input-Referred Current Noise | i_n | f = 1 kHz | | 0.6 | fA/\sqrt{Hz} | | |

5. $V_{DD} = \pm 5 V$ is shorthand for $V_{DD} = +5 V$ and $V_{EE} = -5 V$.

TLV271, TLV272, NCV272, TLV274, NCV274

TLV/NCV 272/274 DC ELECTRICAL CHARACTERISTICS

(($V_{DD} = 2.7\text{ V}, 5\text{ V}, 10\text{ V}, 36\text{ V}$), $T_A = 25^\circ\text{C}$, $R_L \geq 10\text{ k}\Omega$ unless otherwise noted)

| Parameter | Symbol | Conditions | | Min | Typ | Max | Unit |
|--|----------|--|-------------------------|-------------|------------|-------------|---------------|
| Output Swing (High-level) | V_{OH} | $V_{IC} = V_{DD}/2$ | $V_{DD} = 2.7\text{ V}$ | | 0.006 | 0.15 | V |
| | | $T_A = -40^\circ\text{C to } +125^\circ\text{C}$ | | | | 0.22 | |
| | | $V_{IC} = V_{DD}/2$ | $V_{DD} = 5\text{ V}$ | | 0.013 | 0.20 | |
| | | $T_A = -40^\circ\text{C to } +125^\circ\text{C}$ | | | | 0.25 | |
| | | $V_{IC} = V_{DD}/2$ | $V_{DD} = 10\text{ V}$ | | 0.023 | 0.08 | |
| | | $T_A = -40^\circ\text{C to } +125^\circ\text{C}$ | | | | 0.10 | |
| | | $V_{IC} = V_{DD}/2$ | $V_{DD} = 36\text{ V}$ | | 0.074 | 0.10 | |
| $T_A = -40^\circ\text{C to } +125^\circ\text{C}$ | | | | 0.15 | | | |
| Output Swing (Low-level) | V_{OL} | $V_{IC} = V_{DD}/2$ | $V_{DD} = 2.7\text{ V}$ | | 0.005 | 0.15 | V |
| | | $T_A = -40^\circ\text{C to } +125^\circ\text{C}$ | | | | 0.22 | |
| | | $V_{IC} = V_{DD}/2$ | $V_{DD} = 5\text{ V}$ | | 0.01 | 0.10 | |
| | | $T_A = -40^\circ\text{C to } +125^\circ\text{C}$ | | | | 0.15 | |
| | | $V_{IC} = V_{DD}/2$ | $V_{DD} = 10\text{ V}$ | | 0.022 | 0.3 | |
| | | $T_A = -40^\circ\text{C to } +125^\circ\text{C}$ | | | | 0.35 | |
| | | $V_{IC} = V_{DD}/2$ | $V_{DD} = 36\text{ V}$ | | 0.065 | 0.3 | |
| $T_A = -40^\circ\text{C to } +125^\circ\text{C}$ | | | | 0.35 | | | |
| Output Current | I_O | $V_{DD} = 2.7\text{ V}$ | Positive rail | | 50 | | mA |
| | | | Negative rail | | 70 | | |
| | | $V_{DD} = 5\text{ V}$ | Positive rail | | 60 | | |
| | | | Negative rail | | 50 | | |
| | | $V_{DD} = 10\text{ V}$ | Positive rail | | 65 | | |
| | | | Negative rail | | 50 | | |
| | | $V_{DD} = 36\text{ V}$ | Positive rail | | 65 | | |
| Negative rail | | | 50 | | | | |
| Power Supply Quiescent Current | I_{DD} | $V_O = V_{DD}/2,$ Per channel, no load | $V_{DD} = 2.7\text{ V}$ | | 405 | 525 | μA |
| | | | $V_{DD} = 5\text{ V}$ | | 410 | 530 | |
| | | | $V_{DD} = 10\text{ V}$ | | 416 | 540 | |
| | | | $V_{DD} = 36\text{ V}$ | | 465 | 600 | |
| | | $T_A = -40^\circ\text{C to } +105^\circ\text{C}$ | | | 700 | | |

NOTE: Power dissipation must be limited to prevent junction temperature from exceeding 150°C . See Absolute Maximum Ratings for more information.

TLV271, TLV272, NCV272, TLV274, NCV274

TLV/NCV 272/274 AC ELECTRICAL CHARACTERISTICS

(($V_{DD} = 2.7\text{ V}, 5\text{ V}, 10\text{ V}, 36\text{ V}$), $T_A = 25^\circ\text{C}$, and $R_L \geq 10\text{ k}\Omega$ unless otherwise noted)

| Parameter | Symbol | Conditions | | Min | Typ | Max | Unit |
|--------------------------------------|------------|--|-------------------------|-----|-------|-----|------------------------|
| Unity Gain Bandwidth | UGBW | $C_L = 25\text{ pF}$ | $V_{DD} = 2.7\text{ V}$ | | 3 | | MHz |
| Slew Rate at Unity Gain | SR | $C_L = 20\text{ pF}, R_L = 2\text{ k}\Omega$ | $V_{DD} = 2.7\text{ V}$ | | 2.8 | | V/ μS |
| | | | $V_{DD} = 5\text{ V}$ | | 2.7 | | |
| | | | $V_{DD} = 10\text{ V}$ | | 2.6 | | |
| | | | $V_{DD} = 36\text{ V}$ | | 2.4 | | |
| Phase Margin | θ_m | $C_L = 25\text{ pF}$ | | | 50 | | $^\circ$ |
| Gain Margin | | $C_L = 25\text{ pF}$ | | | 14 | | dB |
| Settling Time to 0.1% | t_S | $V_O = 1\text{ V}_{pp}, \text{Gain} = 1, C_L = 20\text{ pF}$ | $V_{DD} = 2.7\text{ V}$ | | 0.6 | | μS |
| | | $V_O = 3\text{ V}_{pp}, \text{Gain} = 1, C_L = 20\text{ pF}$ | $V_{DD} = 5\text{ V}$ | | 1.2 | | |
| | | $V_O = 8.5\text{ V}_{pp}, \text{Gain} = 1, C_L = 20\text{ pF}$ | $V_{DD} = 10\text{ V}$ | | 3.4 | | |
| | | $V_O = 10\text{ V}_{pp}, \text{Gain} = 1, C_L = 20\text{ pF}$ | $V_{DD} = 36\text{ V}$ | | 3.2 | | |
| Total Harmonic Distortion plus Noise | THD+N | $V_{IN} = 0.5\text{ V}_{pp}, f = 1\text{ kHz}, A_v = 1$ | $V_{DD} = 2.7\text{ V}$ | | 0.05 | | % |
| | | $V_{IN} = 2.5\text{ V}_{pp}, f = 1\text{ kHz}, A_v = 1$ | $V_{DD} = 5\text{ V}$ | | 0.009 | | |
| | | $V_{IN} = 7.5\text{ V}_{pp}, f = 1\text{ kHz}, A_v = 1$ | $V_{DD} = 10\text{ V}$ | | 0.004 | | |
| | | $V_{IN} = 28.5\text{ V}_{pp}, f = 1\text{ kHz}, A_v = 1$ | $V_{DD} = 36\text{ V}$ | | 0.001 | | |
| Input-Referred Voltage Noise | e_n | $f = 1\text{ kHz}$ | | | 30 | | nV/ $\sqrt{\text{Hz}}$ |
| | | $f = 10\text{ kHz}$ | | | 20 | | |
| Input-Referred Current Noise | i_n | $f = 1\text{ kHz}$ | | | 90 | | fA/ $\sqrt{\text{Hz}}$ |

TYPICAL CHARACTERISTICS

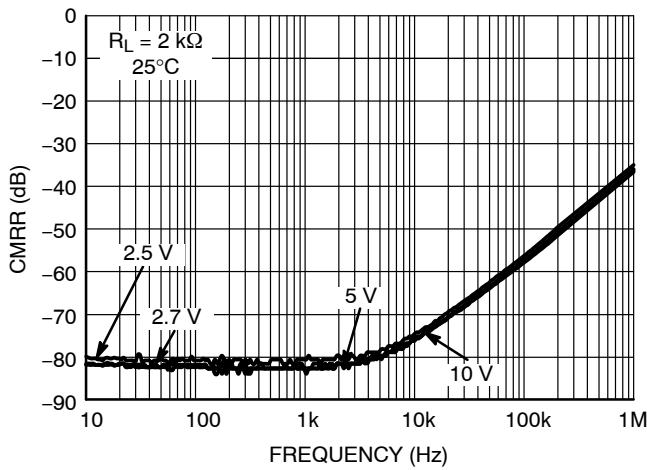

Figure 1. CMRR vs. Frequency for TLV271

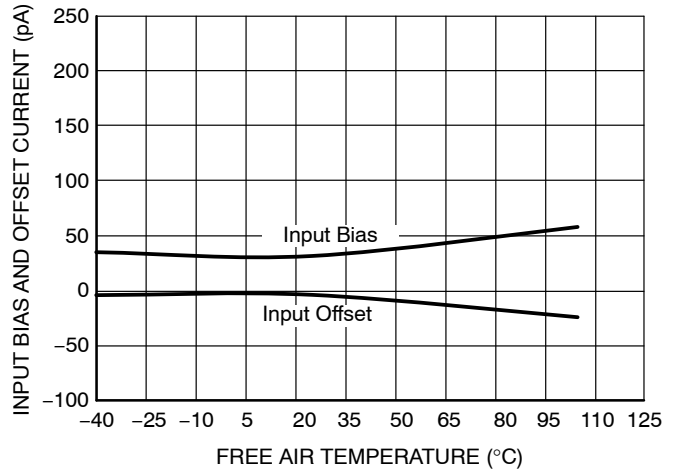

Figure 2. Input Bias and Offset Current vs. Temperature for TLV271

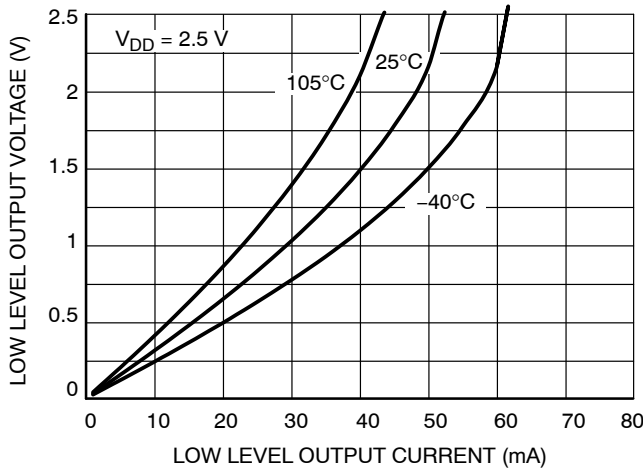

Figure 3. 2.5 V V_{OL} vs. I_{out}

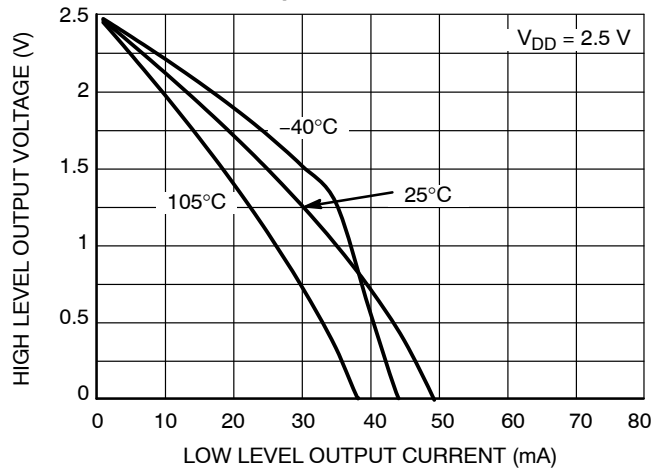

Figure 4. 2.5 V V_{OH} vs. I_{out}

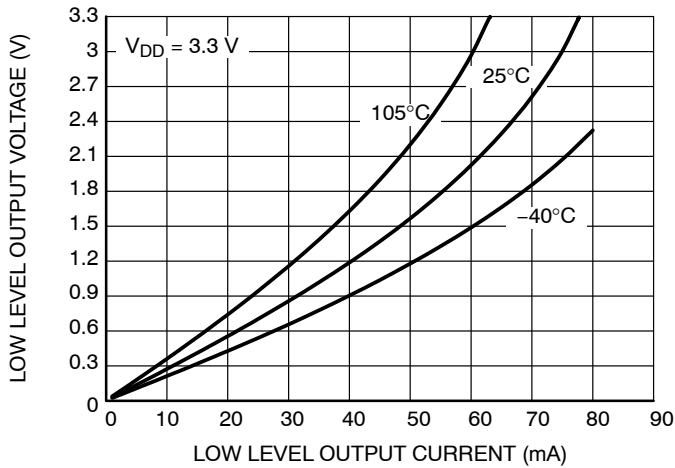

Figure 5. 3.3 V V_{OL} vs. I_{out}

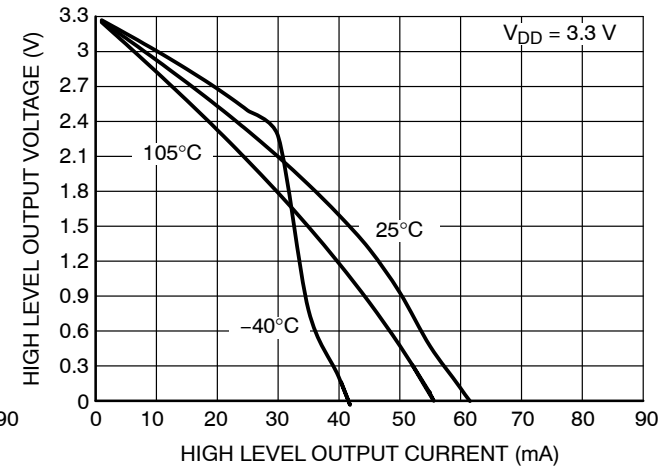

Figure 6. 3.3 V V_{OH} vs. I_{out}

TYPICAL CHARACTERISTICS

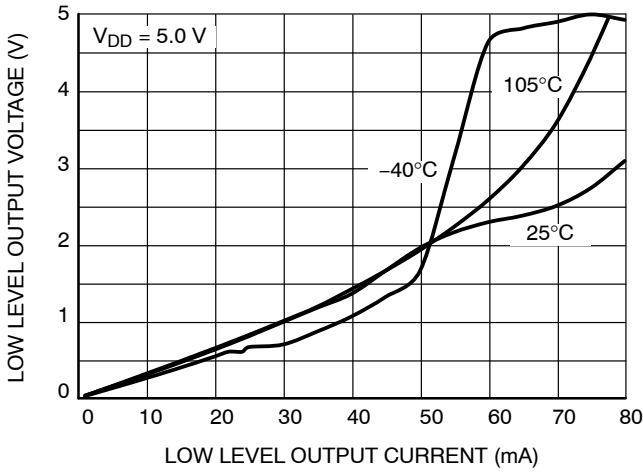

Figure 7. V_{OL} vs. I_{out}

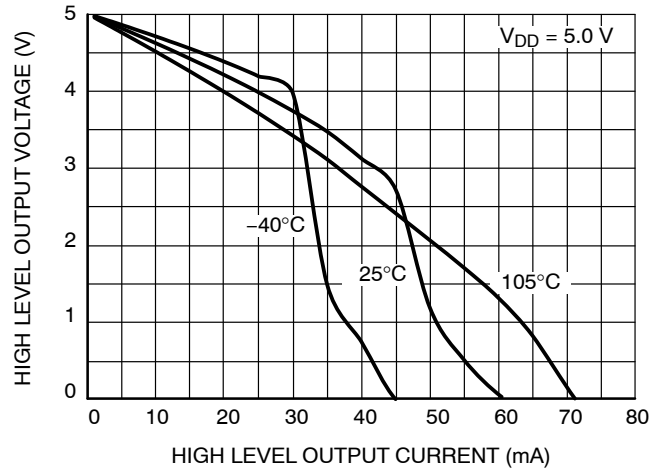

Figure 8. V_{OH} vs. I_{out}

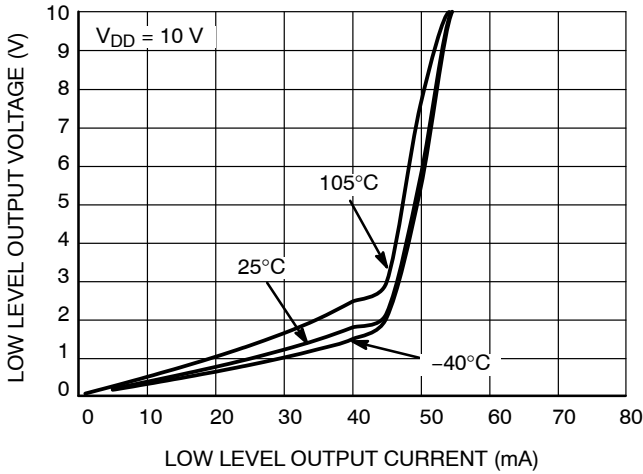

Figure 9. 10 V V_{OL} vs. I_{out}

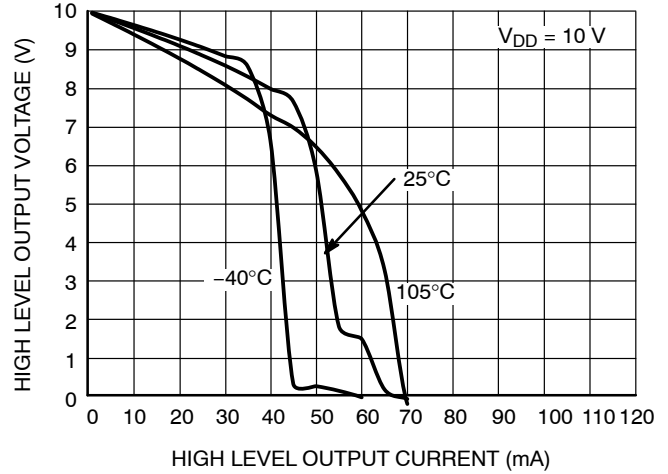

Figure 10. 10 V V_{OH} vs. I_{out}

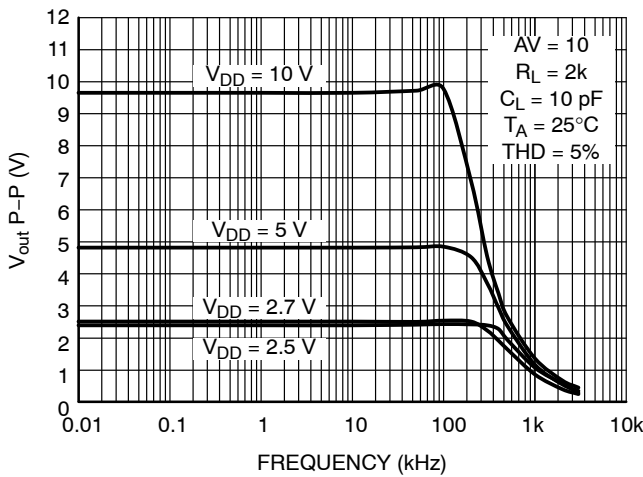

Figure 11. Peak-to-Peak Output vs. Supply vs. Frequency

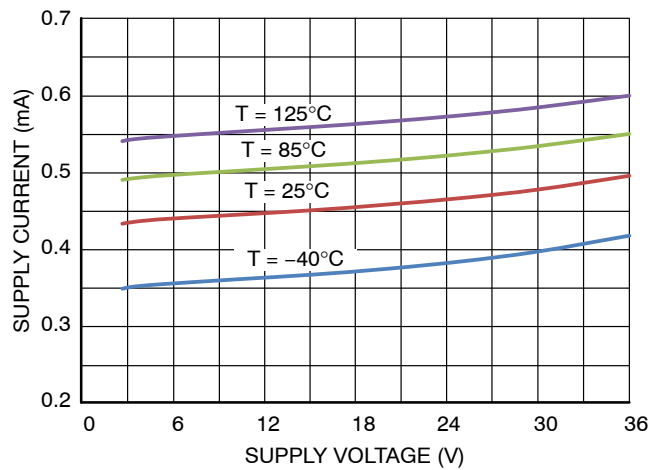

Figure 12. Quiescent Current Per Channel vs. Supply Voltage for TLV/NCV272/274

TLV271, TLV272, NCV272, TLV274, NCV274

TYPICAL CHARACTERISTICS

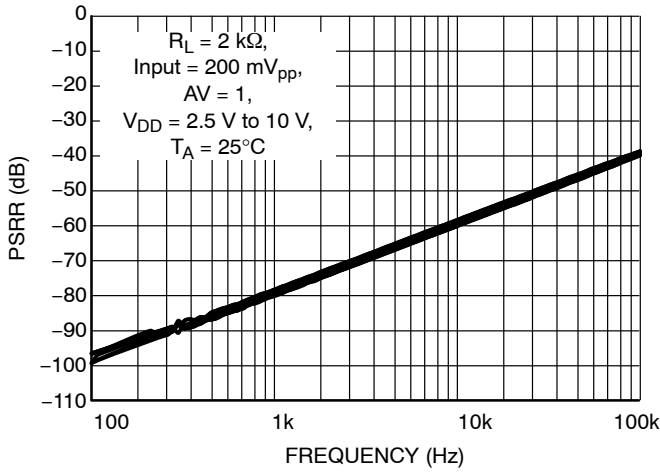

Figure 13. PSRR vs. Frequency for TLV271

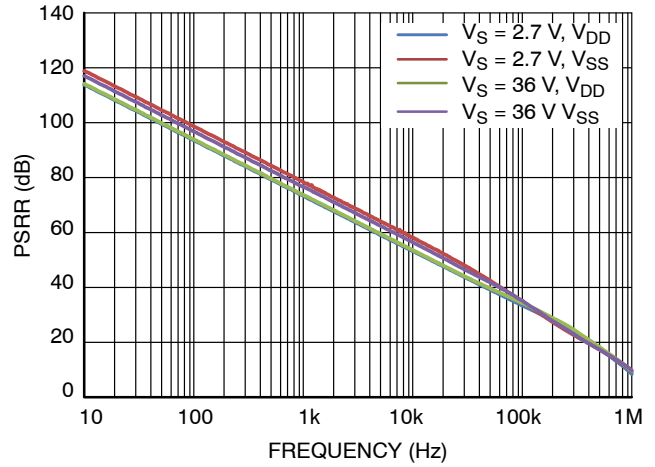

Figure 14. PSRR vs. Frequency for TLV/NCV272/274

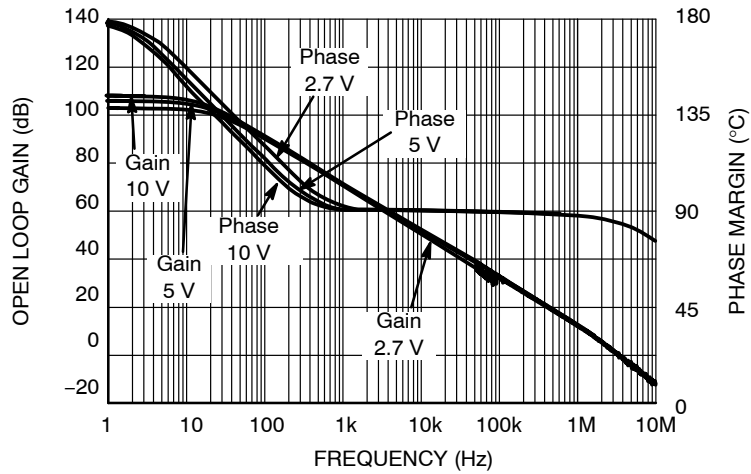

Figure 15. Open Loop Gain and Phase vs. Frequency

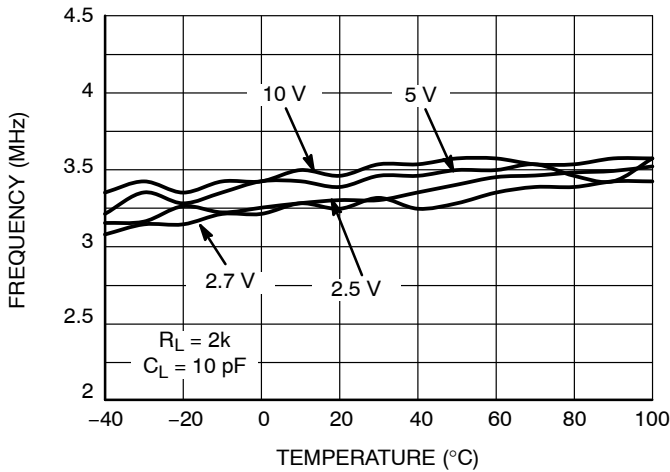

Figure 16. Gain Bandwidth Product vs. Temperature

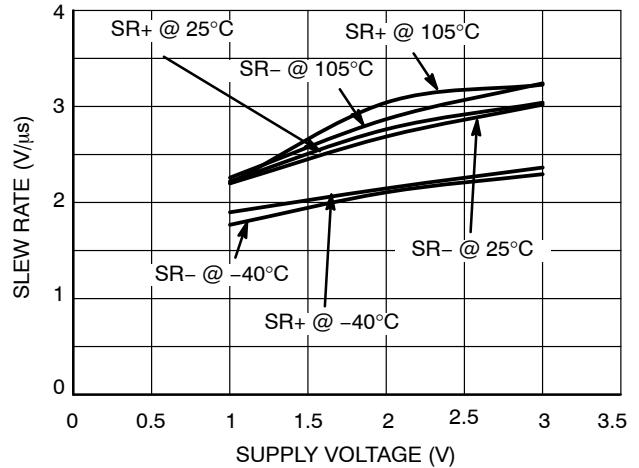

Figure 17. Slew Rate vs. Supply Voltage

TYPICAL CHARACTERISTICS

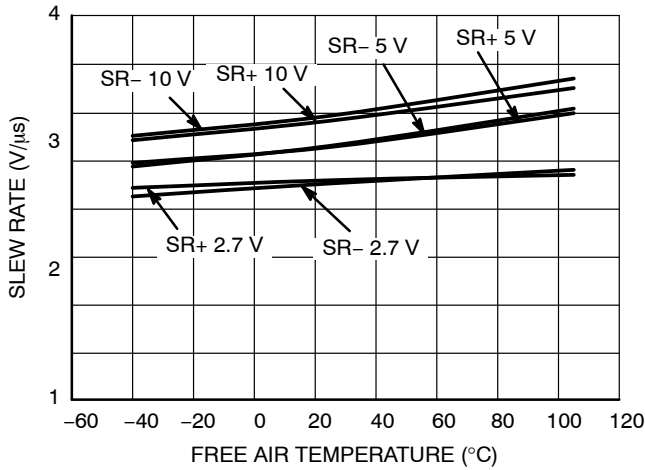

Figure 18. Slew Rate vs. Temperature

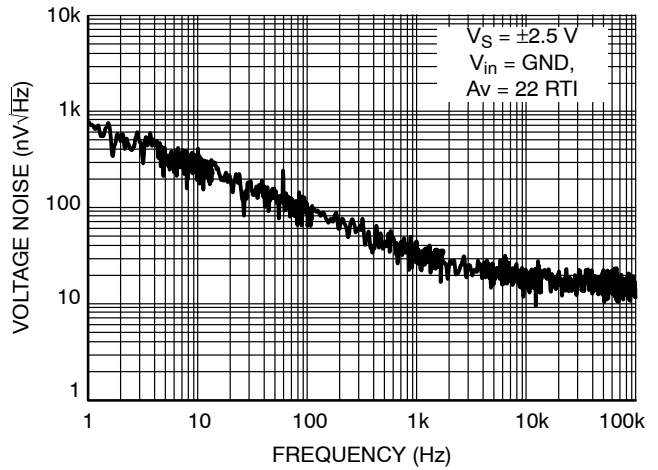

Figure 19. Voltage Noise vs. Frequency

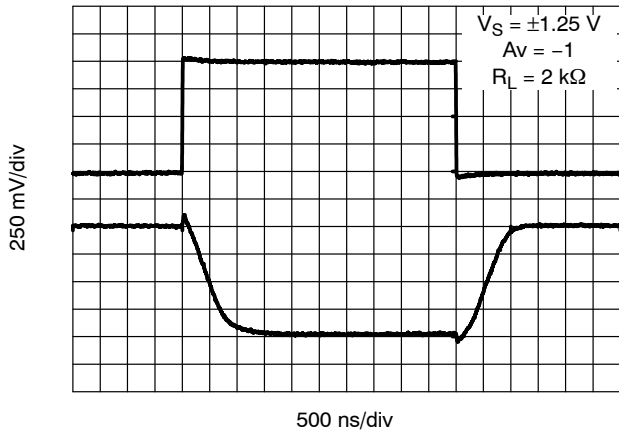

Figure 20. 2.5 V Inverting Large Signal Pulse Response

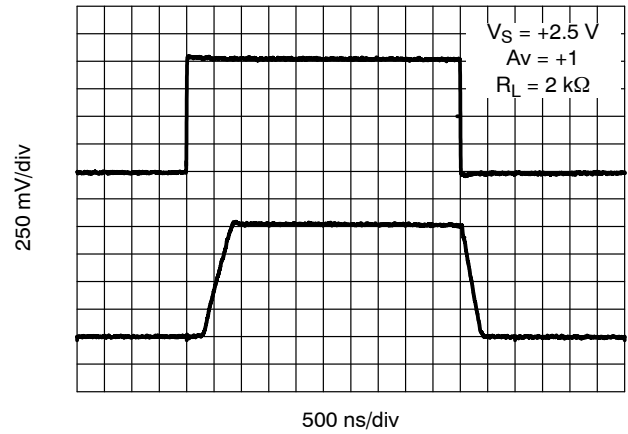

Figure 21. 2.5 V Non-Inverting Large Signal Pulse Response

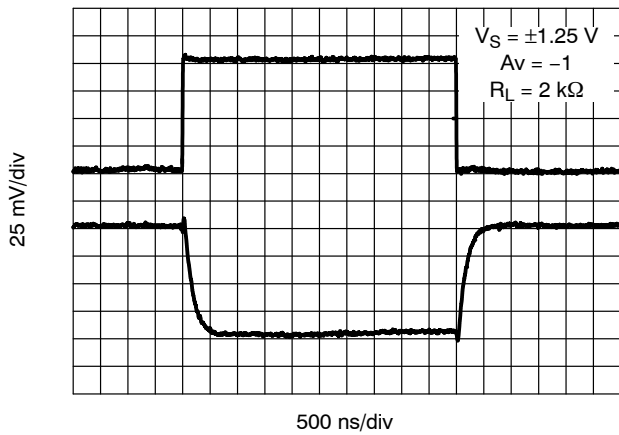

Figure 22. 2.5 V Inverting Small Signal Pulse Response

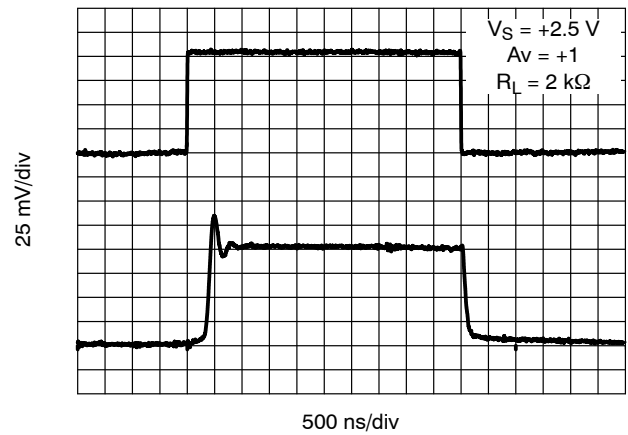
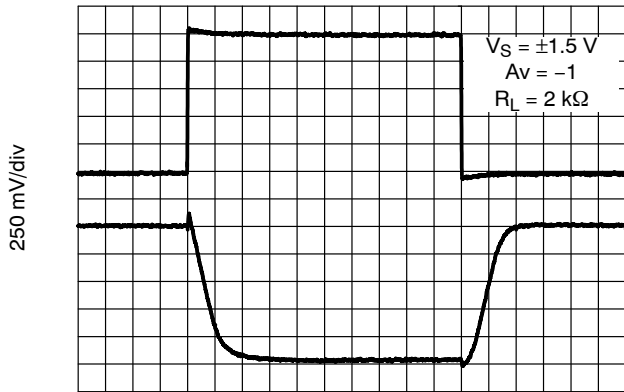

Figure 23. 2.5 V Non-Inverting Small Signal Pulse Response

TYPICAL CHARACTERISTICS



500 ns/div

Figure 24. 3 V Inverting Large Signal Pulse Response

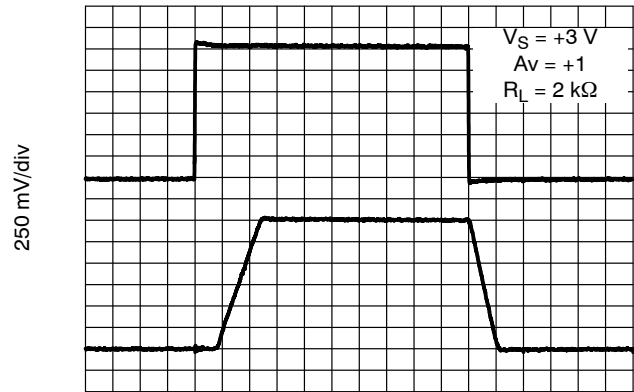

500 ns/div

Figure 25. 3 V Non-Inverting Large Signal Pulse Response

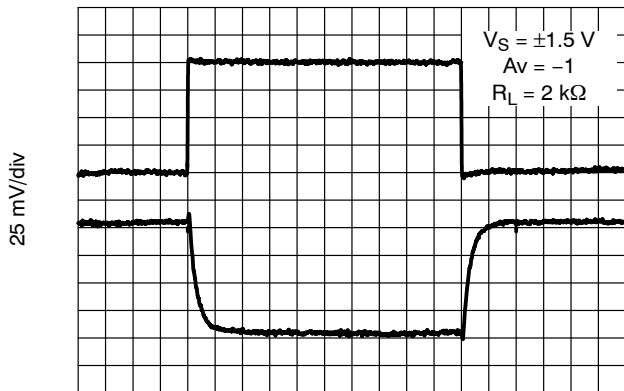

500 ns/div

Figure 26. 3 V Inverting Small Signal Pulse Response

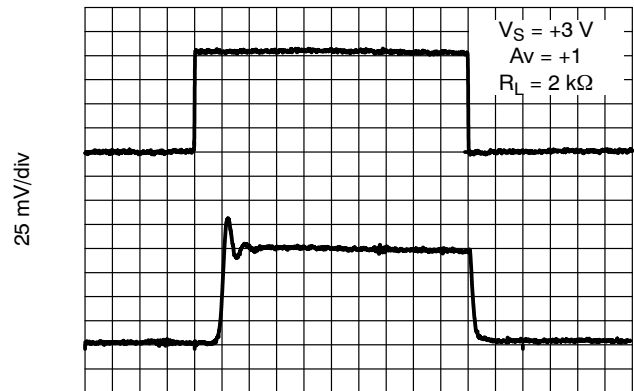

500 ns/div

Figure 27. 3 V Non-Inverting Small Signal Pulse Response

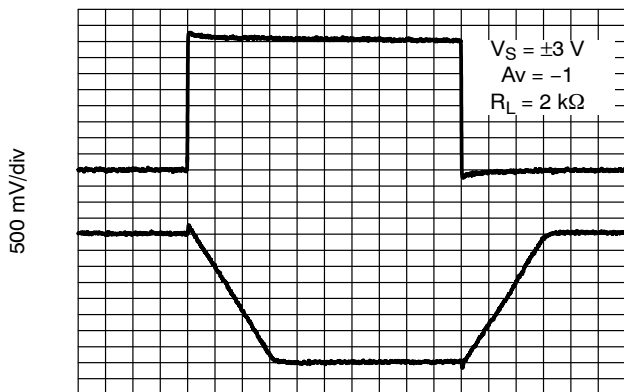

500 ns/div

Figure 28. 6 V Inverting Large Signal Pulse Response

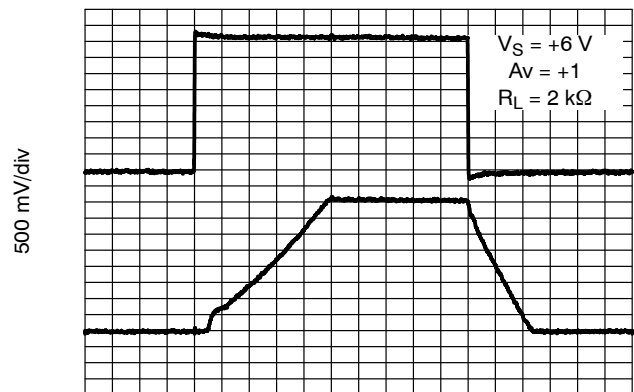

500 ns/div

Figure 29. 6 V Non-Inverting Large Signal Pulse Response

TYPICAL CHARACTERISTICS

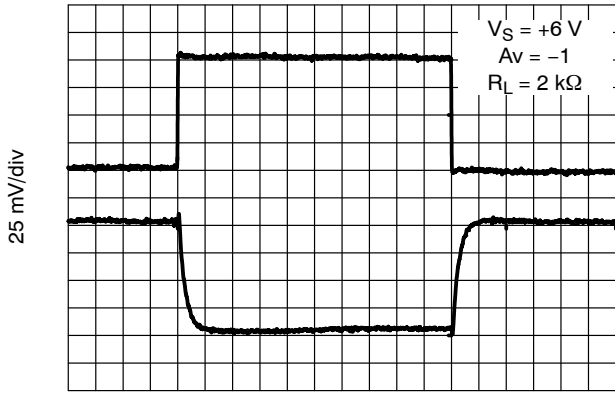

500 ns/div
Figure 30. 6 V Inverting Small Signal Pulse Response

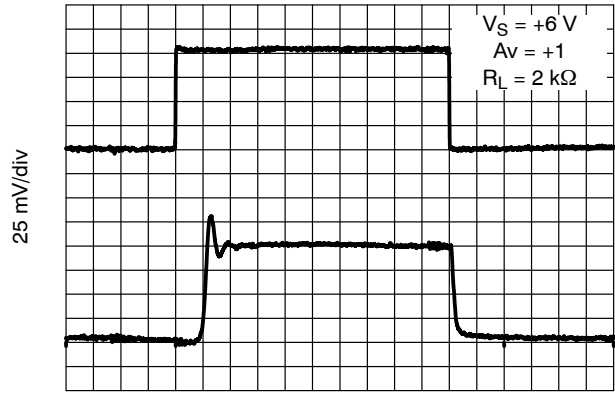

500 ns/div
Figure 31. 6 V Non-Inverting Small Signal Pulse Response

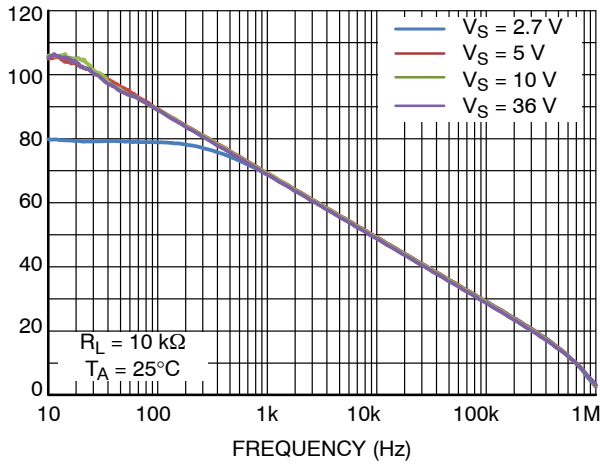

Figure 32. CMRR vs. Frequency for TLV/NCV272/274

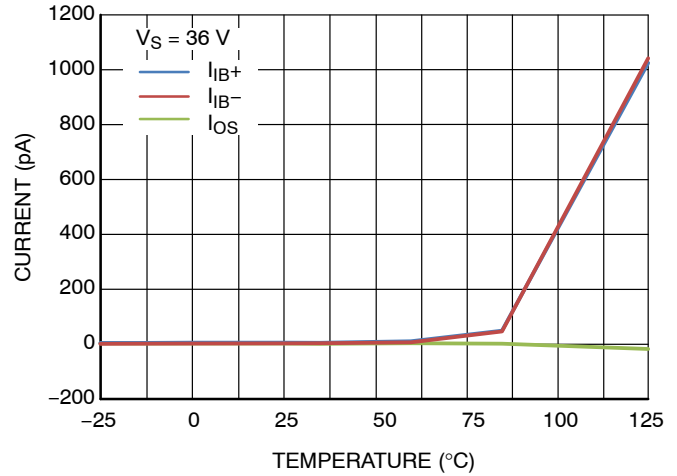

Figure 33. Input Bias and Offset Current vs. Temperature for TLV/NCV272/274

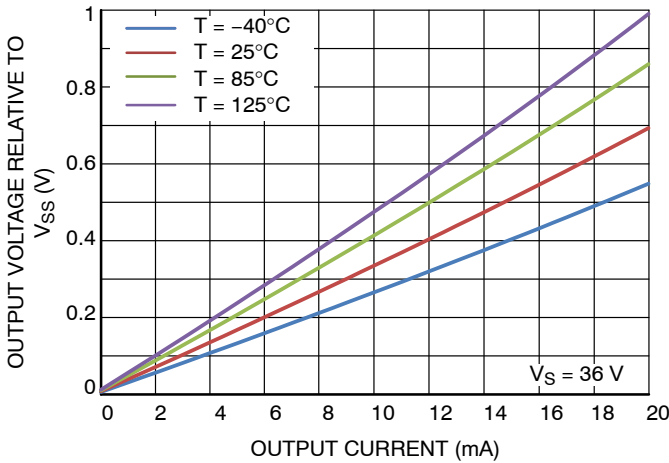

Figure 34. Low Level Output vs. Output Current for TLV/NCV272/274

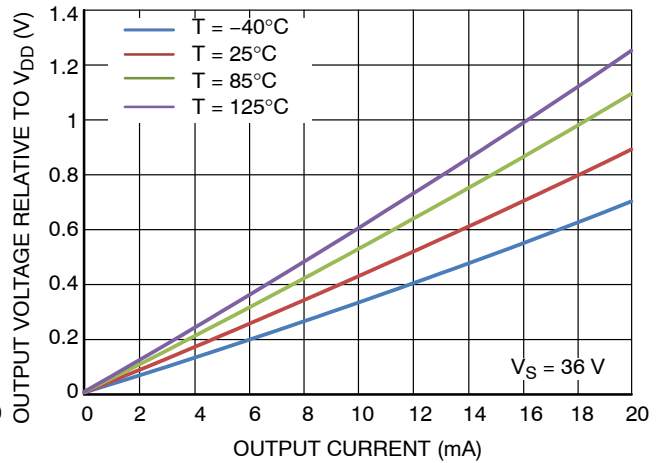

Figure 35. High Level Output vs. Output Current for TLV/NCV272/274

TYPICAL CHARACTERISTICS

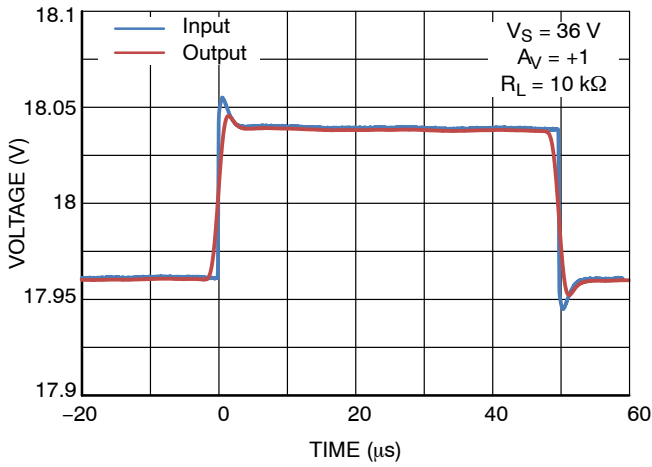

Figure 36. Non-inverting Small Signal Transient Response for TLV/NCV272/274

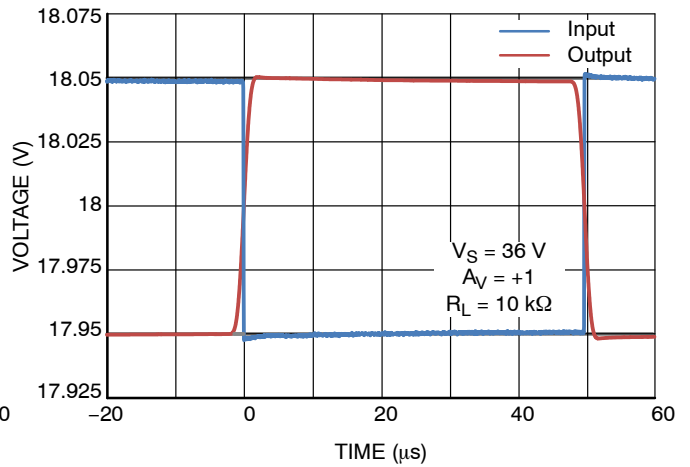

Figure 37. Inverting Small Signal Transient Response for TLV/NCV272/274

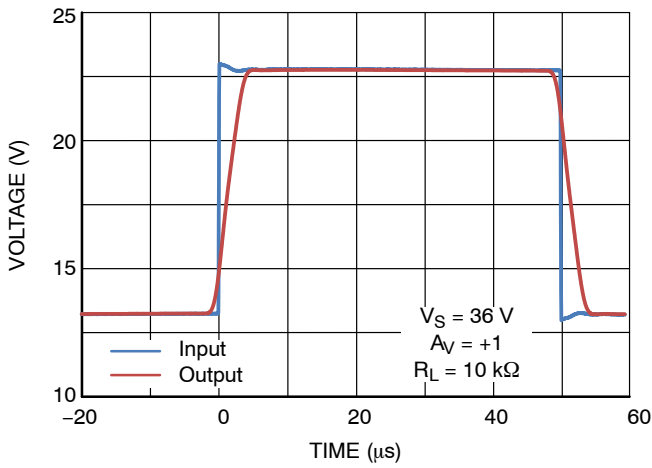

Figure 38. Non-inverting Large Signal Transient Response for TLV/NCV272/274

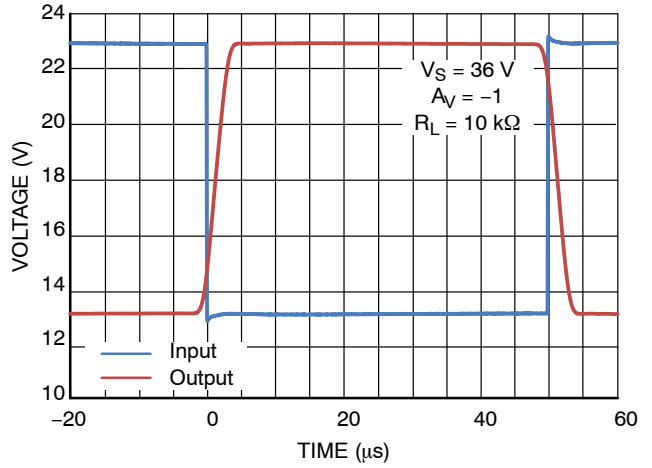

Figure 39. Inverting Large Signal Transient Response for TLV/NCV272/274

APPLICATIONS

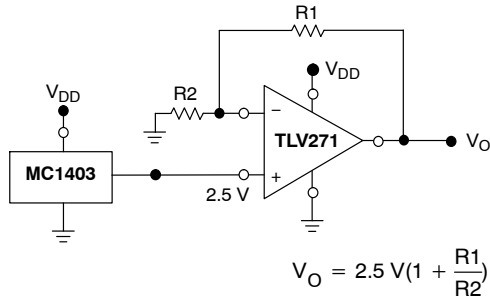

Figure 40. Voltage Reference

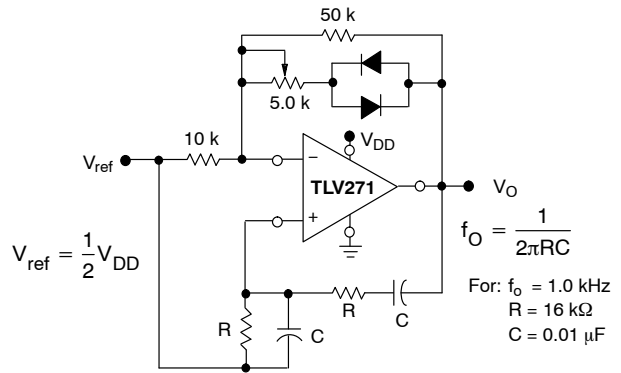

Figure 41. Wien Bridge Oscillator

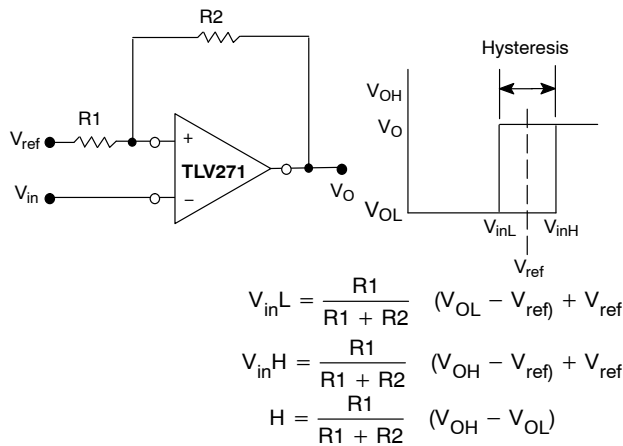
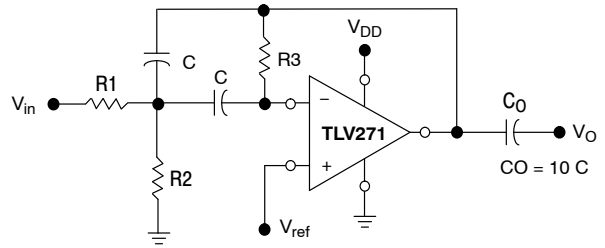

Figure 42. Comparator with Hysteresis



Given: f_o = center frequency
 $A(f_o)$ = gain at center frequency

Choose value f_o, C
 Then: $R3 = \frac{C}{\pi f_o C Q}$
 $R1 = \frac{R3}{2 A(f_o)}$
 $R2 = \frac{R1 R3}{4Q^2 R1 - R3}$

For less than 10% error from operational amplifier,
 $((Q_o f_o)/BW) < 0.1$ where f_o and BW are expressed in Hz.
 If source impedance varies, filter may be preceded with
 voltage follower buffer to stabilize filter parameters.

Figure 43. Multiple Feedback Bandpass Filter

MECHANICAL CASE OUTLINE PACKAGE DIMENSIONS

ON Semiconductor®



SCALE 2:1

TSOP-5 CASE 483 ISSUE N

DATE 12 AUG 2020



NOTES:

1. DIMENSIONING AND TOLERANCING PER ASME Y14.5M, 1994.
2. CONTROLLING DIMENSION: MILLIMETERS.
3. MAXIMUM LEAD THICKNESS INCLUDES LEAD FINISH THICKNESS. MINIMUM LEAD THICKNESS IS THE MINIMUM THICKNESS OF BASE MATERIAL.
4. DIMENSIONS A AND B DO NOT INCLUDE MOLD FLASH, PROTRUSIONS, OR GATE BURRS. MOLD FLASH, PROTRUSIONS, OR GATE BURRS SHALL NOT EXCEED 0.15 PER SIDE. DIMENSION A.
5. OPTIONAL CONSTRUCTION: AN ADDITIONAL TRIMMED LEAD IS ALLOWED IN THIS LOCATION. TRIMMED LEAD NOT TO EXTEND MORE THAN 0.2 FROM BODY.

| DIM | MILLIMETERS | |
|-----|-------------|------|
| | MIN | MAX |
| A | 2.85 | 3.15 |
| B | 1.35 | 1.65 |
| C | 0.90 | 1.10 |
| D | 0.25 | 0.50 |
| G | 0.95 BSC | |
| H | 0.01 | 0.10 |
| J | 0.10 | 0.26 |
| K | 0.20 | 0.60 |
| M | 0° | 10° |
| S | 2.50 | 3.00 |

SOLDERING FOOTPRINT*



GENERIC MARKING DIAGRAM*

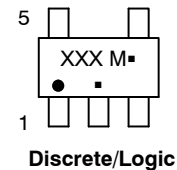
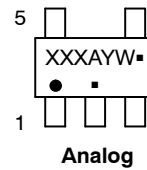

- XXX = Specific Device Code
 A = Assembly Location
 Y = Year
 W = Work Week
 ■ = Pb-Free Package
- XXX = Specific Device Code
 M = Date Code
 ■ = Pb-Free Package

(Note: Microdot may be in either location)

*This information is generic. Please refer to device data sheet for actual part marking. Pb-Free indicator, "G" or microdot "■", may or may not be present.

*For additional information on our Pb-Free strategy and soldering details, please download the ON Semiconductor Soldering and Mounting Techniques Reference Manual, SOLDERRM/D.

| | | |
|------------------|-------------|--|
| DOCUMENT NUMBER: | 98ARB18753C | Electronic versions are uncontrolled except when accessed directly from the Document Repository. Printed versions are uncontrolled except when stamped "CONTROLLED COPY" in red. |
| DESCRIPTION: | TSOP-5 | PAGE 1 OF 1 |

ON Semiconductor and ON are trademarks of Semiconductor Components Industries, LLC dba ON Semiconductor or its subsidiaries in the United States and/or other countries. ON Semiconductor reserves the right to make changes without further notice to any products herein. ON Semiconductor makes no warranty, representation or guarantee regarding the suitability of its products for any particular purpose, nor does ON Semiconductor assume any liability arising out of the application or use of any product or circuit, and specifically disclaims any and all liability, including without limitation special, consequential or incidental damages. ON Semiconductor does not convey any license under its patent rights nor the rights of others.

MECHANICAL CASE OUTLINE PACKAGE DIMENSIONS



SCALE 1:1

SOIC-8 NB
CASE 751-07
ISSUE AK

DATE 16 FEB 2011



- NOTES:
1. DIMENSIONING AND TOLERANCING PER ANSI Y14.5M, 1982.
 2. CONTROLLING DIMENSION: MILLIMETER.
 3. DIMENSION A AND B DO NOT INCLUDE MOLD PROTRUSION.
 4. MAXIMUM MOLD PROTRUSION 0.15 (0.006) PER SIDE.
 5. DIMENSION D DOES NOT INCLUDE DAMBAR PROTRUSION. ALLOWABLE DAMBAR PROTRUSION SHALL BE 0.127 (0.005) TOTAL IN EXCESS OF THE D DIMENSION AT MAXIMUM MATERIAL CONDITION.
 6. 751-01 THRU 751-06 ARE OBSOLETE. NEW STANDARD IS 751-07.

| DIM | MILLIMETERS | | INCHES | |
|-----|-------------|------|-----------|-------|
| | MIN | MAX | MIN | MAX |
| A | 4.80 | 5.00 | 0.189 | 0.197 |
| B | 3.80 | 4.00 | 0.150 | 0.157 |
| C | 1.35 | 1.75 | 0.053 | 0.069 |
| D | 0.33 | 0.51 | 0.013 | 0.020 |
| G | 1.27 BSC | | 0.050 BSC | |
| H | 0.10 | 0.25 | 0.004 | 0.010 |
| J | 0.19 | 0.25 | 0.007 | 0.010 |
| K | 0.40 | 1.27 | 0.016 | 0.050 |
| M | 0° | 8° | 0° | 8° |
| N | 0.25 | 0.50 | 0.010 | 0.020 |
| S | 5.80 | 6.20 | 0.228 | 0.244 |

GENERIC MARKING DIAGRAM*

SOLDERING FOOTPRINT*



XXXXXX = Specific Device Code
 A = Assembly Location
 L = Wafer Lot
 Y = Year
 W = Work Week
 ■ = Pb-Free Package

XXXXXX = Specific Device Code
 A = Assembly Location
 Y = Year
 WW = Work Week
 ■ = Pb-Free Package

*This information is generic. Please refer to device data sheet for actual part marking. Pb-Free indicator, "G" or microdot "•", may or may not be present. Some products may not follow the Generic Marking.

*For additional information on our Pb-Free strategy and soldering details, please download the ON Semiconductor Soldering and Mounting Techniques Reference Manual, SOLDERRM/D.

STYLES ON PAGE 2

| | | |
|------------------|-------------|--|
| DOCUMENT NUMBER: | 98ASB42564B | Electronic versions are uncontrolled except when accessed directly from the Document Repository. Printed versions are uncontrolled except when stamped "CONTROLLED COPY" in red. |
| DESCRIPTION: | SOIC-8 NB | PAGE 1 OF 2 |

onsemi and ONsemi are trademarks of Semiconductor Components Industries, LLC dba onsemi or its subsidiaries in the United States and/or other countries. onsemi reserves the right to make changes without further notice to any products herein. onsemi makes no warranty, representation or guarantee regarding the suitability of its products for any particular purpose, nor does onsemi assume any liability arising out of the application or use of any product or circuit, and specifically disclaims any and all liability, including without limitation special, consequential or incidental damages. onsemi does not convey any license under its patent rights nor the rights of others.

SOIC-8 NB
CASE 751-07
ISSUE AK

DATE 16 FEB 2011

- | | | | |
|---|--|--|--|
| <p>STYLE 1: PIN 1. EMITTER 2. COLLECTOR 3. COLLECTOR 4. EMITTER 5. EMITTER 6. BASE 7. BASE 8. EMITTER</p> | <p>STYLE 2: PIN 1. COLLECTOR, DIE, #1 2. COLLECTOR, #1 3. COLLECTOR, #2 4. COLLECTOR, #2 5. BASE, #2 6. EMITTER, #2 7. BASE, #1 8. EMITTER, #1</p> | <p>STYLE 3: PIN 1. DRAIN, DIE #1 2. DRAIN, #1 3. DRAIN, #2 4. DRAIN, #2 5. GATE, #2 6. SOURCE, #2 7. GATE, #1 8. SOURCE, #1</p> | <p>STYLE 4: PIN 1. ANODE 2. ANODE 3. ANODE 4. ANODE 5. ANODE 6. ANODE 7. ANODE 8. COMMON CATHODE</p> |
| <p>STYLE 5: PIN 1. DRAIN 2. DRAIN 3. DRAIN 4. DRAIN 5. GATE 6. GATE 7. SOURCE 8. SOURCE</p> | <p>STYLE 6: PIN 1. SOURCE 2. DRAIN 3. DRAIN 4. SOURCE 5. SOURCE 6. GATE 7. GATE 8. SOURCE</p> | <p>STYLE 7: PIN 1. INPUT 2. EXTERNAL BYPASS 3. THIRD STAGE SOURCE 4. GROUND 5. DRAIN 6. GATE 3 7. SECOND STAGE Vd 8. FIRST STAGE Vd</p> | <p>STYLE 8: PIN 1. COLLECTOR, DIE #1 2. BASE, #1 3. BASE, #2 4. COLLECTOR, #2 5. COLLECTOR, #2 6. EMITTER, #2 7. EMITTER, #1 8. COLLECTOR, #1</p> |
| <p>STYLE 9: PIN 1. EMITTER, COMMON 2. COLLECTOR, DIE #1 3. COLLECTOR, DIE #2 4. EMITTER, COMMON 5. EMITTER, COMMON 6. BASE, DIE #2 7. BASE, DIE #1 8. EMITTER, COMMON</p> | <p>STYLE 10: PIN 1. GROUND 2. BIAS 1 3. OUTPUT 4. GROUND 5. GROUND 6. BIAS 2 7. INPUT 8. GROUND</p> | <p>STYLE 11: PIN 1. SOURCE 1 2. GATE 1 3. SOURCE 2 4. GATE 2 5. DRAIN 2 6. DRAIN 2 7. DRAIN 1 8. DRAIN 1</p> | <p>STYLE 12: PIN 1. SOURCE 2. SOURCE 3. SOURCE 4. GATE 5. DRAIN 6. DRAIN 7. DRAIN 8. DRAIN</p> |
| <p>STYLE 13: PIN 1. N.C. 2. SOURCE 3. SOURCE 4. GATE 5. DRAIN 6. DRAIN 7. DRAIN 8. DRAIN</p> | <p>STYLE 14: PIN 1. N-SOURCE 2. N-GATE 3. P-SOURCE 4. P-GATE 5. P-DRAIN 6. P-DRAIN 7. N-DRAIN 8. N-DRAIN</p> | <p>STYLE 15: PIN 1. ANODE 1 2. ANODE 1 3. ANODE 1 4. ANODE 1 5. CATHODE, COMMON 6. CATHODE, COMMON 7. CATHODE, COMMON 8. CATHODE, COMMON</p> | <p>STYLE 16: PIN 1. EMITTER, DIE #1 2. BASE, DIE #1 3. EMITTER, DIE #2 4. BASE, DIE #2 5. COLLECTOR, DIE #2 6. COLLECTOR, DIE #2 7. COLLECTOR, DIE #1 8. COLLECTOR, DIE #1</p> |
| <p>STYLE 17: PIN 1. VCC 2. V2OUT 3. V1OUT 4. TXE 5. RXE 6. VEE 7. GND 8. ACC</p> | <p>STYLE 18: PIN 1. ANODE 2. ANODE 3. SOURCE 4. GATE 5. DRAIN 6. DRAIN 7. CATHODE 8. CATHODE</p> | <p>STYLE 19: PIN 1. SOURCE 1 2. GATE 1 3. SOURCE 2 4. GATE 2 5. DRAIN 2 6. MIRROR 2 7. DRAIN 1 8. MIRROR 1</p> | <p>STYLE 20: PIN 1. SOURCE (N) 2. GATE (N) 3. SOURCE (P) 4. GATE (P) 5. DRAIN 6. DRAIN 7. DRAIN 8. DRAIN</p> |
| <p>STYLE 21: PIN 1. CATHODE 1 2. CATHODE 2 3. CATHODE 3 4. CATHODE 4 5. CATHODE 5 6. COMMON ANODE 7. COMMON ANODE 8. CATHODE 6</p> | <p>STYLE 22: PIN 1. I/O LINE 1 2. COMMON CATHODE/VCC 3. COMMON CATHODE/VCC 4. I/O LINE 3 5. COMMON ANODE/GND 6. I/O LINE 4 7. I/O LINE 5 8. COMMON ANODE/GND</p> | <p>STYLE 23: PIN 1. LINE 1 IN 2. COMMON ANODE/GND 3. COMMON ANODE/GND 4. LINE 2 IN 5. LINE 2 OUT 6. COMMON ANODE/GND 7. COMMON ANODE/GND 8. LINE 1 OUT</p> | <p>STYLE 24: PIN 1. BASE 2. EMITTER 3. COLLECTOR/ANODE 4. COLLECTOR/ANODE 5. CATHODE 6. CATHODE 7. COLLECTOR/ANODE 8. COLLECTOR/ANODE</p> |
| <p>STYLE 25: PIN 1. VIN 2. N/C 3. REXT 4. GND 5. IOUT 6. IOUT 7. IOUT 8. IOUT</p> | <p>STYLE 26: PIN 1. GND 2. dv/dt 3. ENABLE 4. ILIMIT 5. SOURCE 6. SOURCE 7. SOURCE 8. VCC</p> | <p>STYLE 27: PIN 1. ILIMIT 2. OVLO 3. UVLO 4. INPUT+ 5. SOURCE 6. SOURCE 7. SOURCE 8. DRAIN</p> | <p>STYLE 28: PIN 1. SW_TO_GND 2. DASIC_OFF 3. DASIC_SW_DET 4. GND 5. V_MON 6. VBULK 7. VBULK 8. VIN</p> |
| <p>STYLE 29: PIN 1. BASE, DIE #1 2. EMITTER, #1 3. BASE, #2 4. EMITTER, #2 5. COLLECTOR, #2 6. COLLECTOR, #2 7. COLLECTOR, #1 8. COLLECTOR, #1</p> | <p>STYLE 30: PIN 1. DRAIN 1 2. DRAIN 1 3. GATE 2 4. SOURCE 2 5. SOURCE 1/DRAIN 2 6. SOURCE 1/DRAIN 2 7. SOURCE 1/DRAIN 2 8. GATE 1</p> | | |

| | | |
|-------------------------|--------------------|---|
| DOCUMENT NUMBER: | 98ASB42564B | Electronic versions are uncontrolled except when accessed directly from the Document Repository. Printed versions are uncontrolled except when stamped "CONTROLLED COPY" in red. |
| DESCRIPTION: | SOIC-8 NB | PAGE 2 OF 2 |

onsemi and **ONSEMI** are trademarks of Semiconductor Components Industries, LLC dba **onsemi** or its subsidiaries in the United States and/or other countries. **onsemi** reserves the right to make changes without further notice to any products herein. **onsemi** makes no warranty, representation or guarantee regarding the suitability of its products for any particular purpose, nor does **onsemi** assume any liability arising out of the application or use of any product or circuit, and specifically disclaims any and all liability, including without limitation special, consequential or incidental damages. **onsemi** does not convey any license under its patent rights nor the rights of others.

MECHANICAL CASE OUTLINE PACKAGE DIMENSIONS



SCALE 1:1

SOIC-14 NB
CASE 751A-03
ISSUE L

DATE 03 FEB 2016

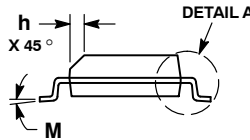

NOTES:

1. DIMENSIONING AND TOLERANCING PER ASME Y14.5M, 1994.
2. CONTROLLING DIMENSION: MILLIMETERS.
3. DIMENSION b DOES NOT INCLUDE DAMBAR PROTRUSION. ALLOWABLE PROTRUSION SHALL BE 0.13 TOTAL IN EXCESS OF AT MAXIMUM MATERIAL CONDITION.
4. DIMENSIONS D AND E DO NOT INCLUDE MOLD PROTRUSIONS.
5. MAXIMUM MOLD PROTRUSION 0.15 PER SIDE.

| DIM | MILLIMETERS | | INCHES | |
|-----|-------------|------|-----------|-------|
| | MIN | MAX | MIN | MAX |
| A | 1.35 | 1.75 | 0.054 | 0.068 |
| A1 | 0.10 | 0.25 | 0.004 | 0.010 |
| A3 | 0.19 | 0.25 | 0.008 | 0.010 |
| b | 0.35 | 0.49 | 0.014 | 0.019 |
| D | 8.55 | 8.75 | 0.337 | 0.344 |
| E | 3.80 | 4.00 | 0.150 | 0.157 |
| e | 1.27 BSC | | 0.050 BSC | |
| H | 5.80 | 6.20 | 0.228 | 0.244 |
| h | 0.25 | 0.50 | 0.010 | 0.019 |
| L | 0.40 | 1.25 | 0.016 | 0.049 |
| M | 0° | 7° | 0° | 7° |

SOLDERING FOOTPRINT*



DIMENSIONS: MILLIMETERS

*For additional information on our Pb-Free strategy and soldering details, please download the ON Semiconductor Soldering and Mounting Techniques Reference Manual, SOLDERRM/D.

GENERIC MARKING DIAGRAM*



- XXXXXX = Specific Device Code
- A = Assembly Location
- WL = Wafer Lot
- Y = Year
- WW = Work Week
- G = Pb-Free Package

*This information is generic. Please refer to device data sheet for actual part marking. Pb-Free indicator, "G" or microdot "▪", may or may not be present. Some products may not follow the Generic Marking.

STYLES ON PAGE 2

| | | |
|------------------|-------------|--|
| DOCUMENT NUMBER: | 98ASB42565B | Electronic versions are uncontrolled except when accessed directly from the Document Repository. Printed versions are uncontrolled except when stamped "CONTROLLED COPY" in red. |
| DESCRIPTION: | SOIC-14 NB | PAGE 1 OF 2 |

onsemi and ONSEMI are trademarks of Semiconductor Components Industries, LLC dba onsemi or its subsidiaries in the United States and/or other countries. onsemi reserves the right to make changes without further notice to any products herein. onsemi makes no warranty, representation or guarantee regarding the suitability of its products for any particular purpose, nor does onsemi assume any liability arising out of the application or use of any product or circuit, and specifically disclaims any and all liability, including without limitation special, consequential or incidental damages. onsemi does not convey any license under its patent rights nor the rights of others.

SOIC-14
CASE 751A-03
ISSUE L

DATE 03 FEB 2016

STYLE 1:
 PIN 1. COMMON CATHODE
 2. ANODE/CATHODE
 3. ANODE/CATHODE
 4. NO CONNECTION
 5. ANODE/CATHODE
 6. NO CONNECTION
 7. ANODE/CATHODE
 8. ANODE/CATHODE
 9. ANODE/CATHODE
 10. NO CONNECTION
 11. ANODE/CATHODE
 12. ANODE/CATHODE
 13. NO CONNECTION
 14. COMMON ANODE

STYLE 2:
 CANCELLED

STYLE 3:
 PIN 1. NO CONNECTION
 2. ANODE
 3. ANODE
 4. NO CONNECTION
 5. ANODE
 6. NO CONNECTION
 7. ANODE
 8. ANODE
 9. ANODE
 10. NO CONNECTION
 11. ANODE
 12. ANODE
 13. NO CONNECTION
 14. COMMON CATHODE

STYLE 4:
 PIN 1. NO CONNECTION
 2. CATHODE
 3. CATHODE
 4. NO CONNECTION
 5. CATHODE
 6. NO CONNECTION
 7. CATHODE
 8. CATHODE
 9. CATHODE
 10. NO CONNECTION
 11. CATHODE
 12. CATHODE
 13. NO CONNECTION
 14. COMMON ANODE

STYLE 5:
 PIN 1. COMMON CATHODE
 2. ANODE/CATHODE
 3. ANODE/CATHODE
 4. ANODE/CATHODE
 5. ANODE/CATHODE
 6. NO CONNECTION
 7. COMMON ANODE
 8. COMMON CATHODE
 9. ANODE/CATHODE
 10. ANODE/CATHODE
 11. ANODE/CATHODE
 12. ANODE/CATHODE
 13. NO CONNECTION
 14. COMMON ANODE

STYLE 6:
 PIN 1. CATHODE
 2. CATHODE
 3. CATHODE
 4. CATHODE
 5. CATHODE
 6. CATHODE
 7. CATHODE
 8. ANODE
 9. ANODE
 10. ANODE
 11. ANODE
 12. ANODE
 13. ANODE
 14. ANODE

STYLE 7:
 PIN 1. ANODE/CATHODE
 2. COMMON ANODE
 3. COMMON CATHODE
 4. ANODE/CATHODE
 5. ANODE/CATHODE
 6. ANODE/CATHODE
 7. ANODE/CATHODE
 8. ANODE/CATHODE
 9. ANODE/CATHODE
 10. ANODE/CATHODE
 11. COMMON CATHODE
 12. COMMON ANODE
 13. ANODE/CATHODE
 14. ANODE/CATHODE

STYLE 8:
 PIN 1. COMMON CATHODE
 2. ANODE/CATHODE
 3. ANODE/CATHODE
 4. NO CONNECTION
 5. ANODE/CATHODE
 6. ANODE/CATHODE
 7. COMMON ANODE
 8. COMMON ANODE
 9. ANODE/CATHODE
 10. ANODE/CATHODE
 11. NO CONNECTION
 12. ANODE/CATHODE
 13. ANODE/CATHODE
 14. COMMON CATHODE

| | | |
|-------------------------|--------------------|---|
| DOCUMENT NUMBER: | 98ASB42565B | Electronic versions are uncontrolled except when accessed directly from the Document Repository. Printed versions are uncontrolled except when stamped "CONTROLLED COPY" in red. |
| DESCRIPTION: | SOIC-14 NB | PAGE 2 OF 2 |

onsemi and **ONSEMI** are trademarks of Semiconductor Components Industries, LLC dba **onsemi** or its subsidiaries in the United States and/or other countries. **onsemi** reserves the right to make changes without further notice to any products herein. **onsemi** makes no warranty, representation or guarantee regarding the suitability of its products for any particular purpose, nor does **onsemi** assume any liability arising out of the application or use of any product or circuit, and specifically disclaims any and all liability, including without limitation special, consequential or incidental damages. **onsemi** does not convey any license under its patent rights nor the rights of others.

MECHANICAL CASE OUTLINE

PACKAGE DIMENSIONS

ON Semiconductor®



SCALE 2:1

Micro8 CASE 846A-02 ISSUE K

DATE 16 JUL 2020

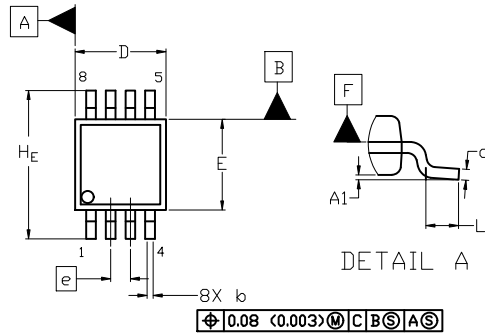

TOP VIEW

NOTE 3



SIDE VIEW



END VIEW

NOTES:

1. DIMENSIONING AND TOLERANCING PER ASME Y14.5M, 2009.
2. CONTROLLING DIMENSION: MILLIMETERS
3. DIMENSION *b* DOES NOT INCLUDE DAMBAR PROTRUSION. ALLOWABLE PROTRUSION SHALL BE 0.10 mm IN EXCESS OF MAXIMUM MATERIAL CONDITION.
4. DIMENSIONS D AND E DO NOT INCLUDE MOLD FLASH, PROTRUSION OR GATE BURRS. MOLD FLASH, PROTRUSIONS, OR GATE BURRS SHALL NOT EXCEED 0.15 mm PER SIDE. DIMENSION E DOES NOT INCLUDE INTERLEAD FLASH OR PROTRUSION. INTERLEAD FLASH OR PROTRUSION SHALL NOT EXCEED 0.25 mm PER SIDE. DIMENSIONS D AND E ARE DETERMINED AT DATUM F.
5. DATUMS A AND B ARE TO BE DETERMINED AT DATUM F.
6. A1 IS DEFINED AS THE VERTICAL DISTANCE FROM THE SEATING PLANE TO THE LOWEST POINT ON THE PACKAGE BODY.

⌀ 0.08 (0.003) M C B S A S

| DIM | MILLIMETERS | | |
|----------------|-------------|------|------|
| | MIN. | NOM. | MAX. |
| A | --- | --- | 1.10 |
| A1 | 0.05 | 0.08 | 0.15 |
| <i>b</i> | 0.25 | 0.33 | 0.40 |
| <i>c</i> | 0.13 | 0.18 | 0.23 |
| D | 2.90 | 3.00 | 3.10 |
| E | 2.90 | 3.00 | 3.10 |
| <i>e</i> | 0.65 BSC | | |
| H _E | 4.75 | 4.90 | 5.05 |
| L | 0.40 | 0.55 | 0.70 |

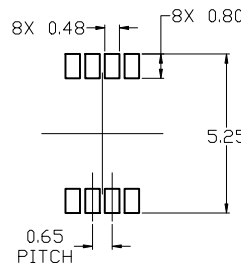

RECOMMENDED MOUNTING FOOTPRINT

For additional information on our Pb-Free strategy and soldering details, please download the ON Semiconductor Soldering and Mounting Techniques Reference Manual, SOLDERM/D.

GENERIC MARKING DIAGRAM*

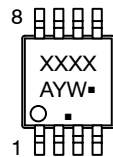

- XXXX = Specific Device Code
- A = Assembly Location
- Y = Year
- W = Work Week
- = Pb-Free Package

(Note: Microdot may be in either location)

*This information is generic. Please refer to device data sheet for actual part marking. Pb-Free indicator, "G" or microdot "▪", may or may not be present. Some products may not follow the Generic Marking.

STYLE 1:

1. SOURCE
2. SOURCE
3. SOURCE
4. GATE
5. DRAIN
6. DRAIN
7. DRAIN
8. DRAIN

STYLE 2:

1. SOURCE 1
2. GATE 1
3. SOURCE 2
4. GATE 2
5. DRAIN 2
6. DRAIN 2
7. DRAIN 1
8. DRAIN 1

STYLE 3:

1. N-SOURCE
2. N-GATE
3. P-SOURCE
4. P-GATE
5. P-DRAIN
6. P-DRAIN
7. N-DRAIN
8. N-DRAIN

| | | |
|-------------------------|--------------------|--|
| DOCUMENT NUMBER: | 98ASB14087C | Electronic versions are uncontrolled except when accessed directly from the Document Repository. Printed versions are uncontrolled except when stamped "CONTROLLED COPY" in red. |
| DESCRIPTION: | MICRO8 | PAGE 1 OF 1 |

ON Semiconductor and ON are trademarks of Semiconductor Components Industries, LLC dba ON Semiconductor or its subsidiaries in the United States and/or other countries. ON Semiconductor reserves the right to make changes without further notice to any products herein. ON Semiconductor makes no warranty, representation or guarantee regarding the suitability of its products for any particular purpose, nor does ON Semiconductor assume any liability arising out of the application or use of any product or circuit, and specifically disclaims any and all liability, including without limitation special, consequential or incidental damages. ON Semiconductor does not convey any license under its patent rights nor the rights of others.

MECHANICAL CASE OUTLINE PACKAGE DIMENSIONS



TSSOP-14 WB
CASE 948G
ISSUE C

DATE 17 FEB 2016

SCALE 2:1



NOTES:

- DIMENSIONING AND TOLERANCING PER ANSI Y14.5M, 1982.
- CONTROLLING DIMENSION: MILLIMETER.
- DIMENSION A DOES NOT INCLUDE MOLD FLASH, PROTRUSIONS OR GATE BURRS. MOLD FLASH OR GATE BURRS SHALL NOT EXCEED 0.15 (0.006) PER SIDE.
- DIMENSION B DOES NOT INCLUDE INTERLEAD FLASH OR PROTRUSION. INTERLEAD FLASH OR PROTRUSION SHALL NOT EXCEED 0.25 (0.010) PER SIDE.
- DIMENSION K DOES NOT INCLUDE DAMBAR PROTRUSION. ALLOWABLE DAMBAR PROTRUSION SHALL BE 0.08 (0.003) TOTAL IN EXCESS OF THE K DIMENSION AT MAXIMUM MATERIAL CONDITION.
- TERMINAL NUMBERS ARE SHOWN FOR REFERENCE ONLY.
- DIMENSION A AND B ARE TO BE DETERMINED AT DATUM PLANE -W-.

| DIM | MILLIMETERS | | INCHES | |
|-----|-------------|------|-----------|-------|
| | MIN | MAX | MIN | MAX |
| A | 4.90 | 5.10 | 0.193 | 0.200 |
| B | 4.30 | 4.50 | 0.169 | 0.177 |
| C | --- | 1.20 | --- | 0.047 |
| D | 0.05 | 0.15 | 0.002 | 0.006 |
| F | 0.50 | 0.75 | 0.020 | 0.030 |
| G | 0.65 BSC | | 0.026 BSC | |
| H | 0.50 | 0.60 | 0.020 | 0.024 |
| J | 0.09 | 0.20 | 0.004 | 0.008 |
| J1 | 0.09 | 0.16 | 0.004 | 0.006 |
| K | 0.19 | 0.30 | 0.007 | 0.012 |
| K1 | 0.19 | 0.25 | 0.007 | 0.010 |
| L | 6.40 BSC | | 0.252 BSC | |
| M | 0° | 8° | 0° | 8° |

GENERIC MARKING DIAGRAM*



- A = Assembly Location
- L = Wafer Lot
- Y = Year
- W = Work Week
- = Pb-Free Package

(Note: Microdot may be in either location)

*This information is generic. Please refer to device data sheet for actual part marking. Pb-Free indicator, "G" or microdot "▪", may or may not be present. Some products may not follow the Generic Marking.

SOLDERING FOOTPRINT

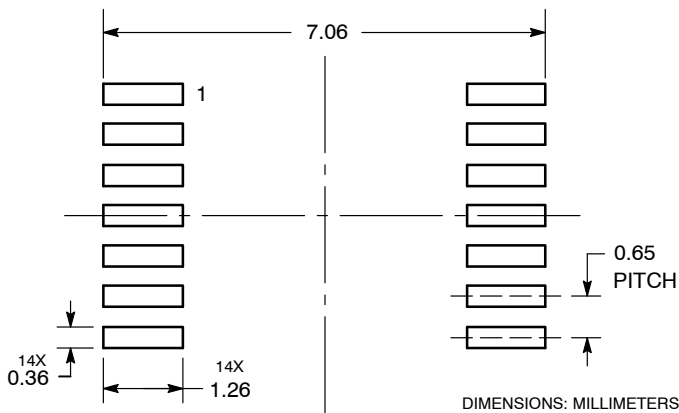

| | | |
|-------------------------|--------------------|--|
| DOCUMENT NUMBER: | 98ASH70246A | Electronic versions are uncontrolled except when accessed directly from the Document Repository. Printed versions are uncontrolled except when stamped "CONTROLLED COPY" in red. |
| DESCRIPTION: | TSSOP-14 WB | PAGE 1 OF 1 |

onsemi and onsemi are trademarks of Semiconductor Components Industries, LLC dba onsemi or its subsidiaries in the United States and/or other countries. onsemi reserves the right to make changes without further notice to any products herein. onsemi makes no warranty, representation or guarantee regarding the suitability of its products for any particular purpose, nor does onsemi assume any liability arising out of the application or use of any product or circuit, and specifically disclaims any and all liability, including without limitation special, consequential or incidental damages. onsemi does not convey any license under its patent rights nor the rights of others.

onsemi, **Onsemi**, and other names, marks, and brands are registered and/or common law trademarks of Semiconductor Components Industries, LLC dba "**onsemi**" or its affiliates and/or subsidiaries in the United States and/or other countries. **onsemi** owns the rights to a number of patents, trademarks, copyrights, trade secrets, and other intellectual property. A listing of **onsemi**'s product/patent coverage may be accessed at www.onsemi.com/site/pdf/Patent-Marking.pdf. **onsemi** reserves the right to make changes at any time to any products or information herein, without notice. The information herein is provided "as-is" and **onsemi** makes no warranty, representation or guarantee regarding the accuracy of the information, product features, availability, functionality, or suitability of its products for any particular purpose, nor does **onsemi** assume any liability arising out of the application or use of any product or circuit, and specifically disclaims any and all liability, including without limitation special, consequential or incidental damages. Buyer is responsible for its products and applications using **onsemi** products, including compliance with all laws, regulations and safety requirements or standards, regardless of any support or applications information provided by **onsemi**. "Typical" parameters which may be provided in **onsemi** data sheets and/or specifications can and do vary in different applications and actual performance may vary over time. All operating parameters, including "Typicals" must be validated for each customer application by customer's technical experts. **onsemi** does not convey any license under any of its intellectual property rights nor the rights of others. **onsemi** products are not designed, intended, or authorized for use as a critical component in life support systems or any FDA Class 3 medical devices or medical devices with a same or similar classification in a foreign jurisdiction or any devices intended for implantation in the human body. Should Buyer purchase or use **onsemi** products for any such unintended or unauthorized application, Buyer shall indemnify and hold **onsemi** and its officers, employees, subsidiaries, affiliates, and distributors harmless against all claims, costs, damages, and expenses, and reasonable attorney fees arising out of, directly or indirectly, any claim of personal injury or death associated with such unintended or unauthorized use, even if such claim alleges that **onsemi** was negligent regarding the design or manufacture of the part. **onsemi** is an Equal Opportunity/Affirmative Action Employer. This literature is subject to all applicable copyright laws and is not for resale in any manner.

PUBLICATION ORDERING INFORMATION

LITERATURE FULFILLMENT:

Email Requests to: orderlit@onsemi.com

onsemi Website: www.onsemi.com

TECHNICAL SUPPORT

North American Technical Support:
Voice Mail: 1 800-282-9855 Toll Free USA/Canada
Phone: 011 421 33 790 2910

Europe, Middle East and Africa Technical Support:

Phone: 00421 33 790 2910

For additional information, please contact your local Sales Representative