

Linear Regulator - Low V_{IN} , Low Noise, High PSRR 200 mA

NCP110

The NCP110 is a linear regulator capable of supplying 200 mA output current from 1.1 V input voltage. The device provides wide output range from 0.6 V up to 4.0 V, very low noise and high PSRR. Due to low quiescent current the NCP110 is suitable for battery powered devices such as smartphones and tablets. The device is designed to work with a 1 μ F input and a 1 μ F output ceramic capacitor. It is available in ultra-small 0.35P, 0.64 mm x 0.64 mm Chip Scale Package (CSP) and XDFN4 0.65P, 1 mm x 1 mm.

Features

- Operating Input Voltage Range: 1.1 V to 5.5 V
- Available in Fixed Voltage Option: 0.6 V to 4.0 V
- $\pm 2\%$ Accuracy Over Temperature
- Ultra Low Quiescent Current Typ. 20 μ A
- Standby Current: Typ. 0.1 μ A
- Very Low Dropout: 70 mV for 1.05 V @ 100 mA
- High PSRR: Typ. 95 dB at 20 mA, f = 1 kHz
- Ultra Low Noise: 8.8 μ V_{RMS}
- Stable with a 1 μ F Small Case Size Ceramic Capacitors
- Available in -WLCSP4 0.64mm x 0.64mm x 0.33mm - Case 567VS
-XDFN4 1mm x 1mm x 0.4mm - Case 711AJ
- These Devices are Pb-Free, Halogen Free/BFR Free and are RoHS Compliant

Typical Applications

- Battery-powered Equipment
- Smartphone, Tablets
- Digital Cameras
- Smoke Detectors
- Portable Medical Equipment
- RF, PLL, VCO and Clock Power Supplies
- Battery Powered Wireless IoT Modules

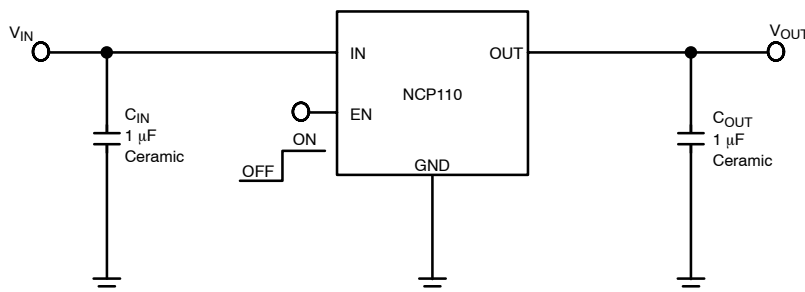

Figure 1. Typical Application Schematics

MARKING DIAGRAMS



X or XX = Specific Device Code
M = Date Code

PIN CONNECTIONS

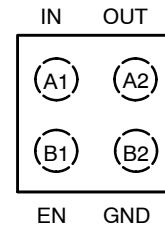

(Top View)

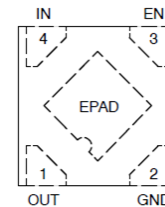

(Top View)

ORDERING INFORMATION

See detailed ordering, marking and shipping information on page 14 of this data sheet.

NCP110

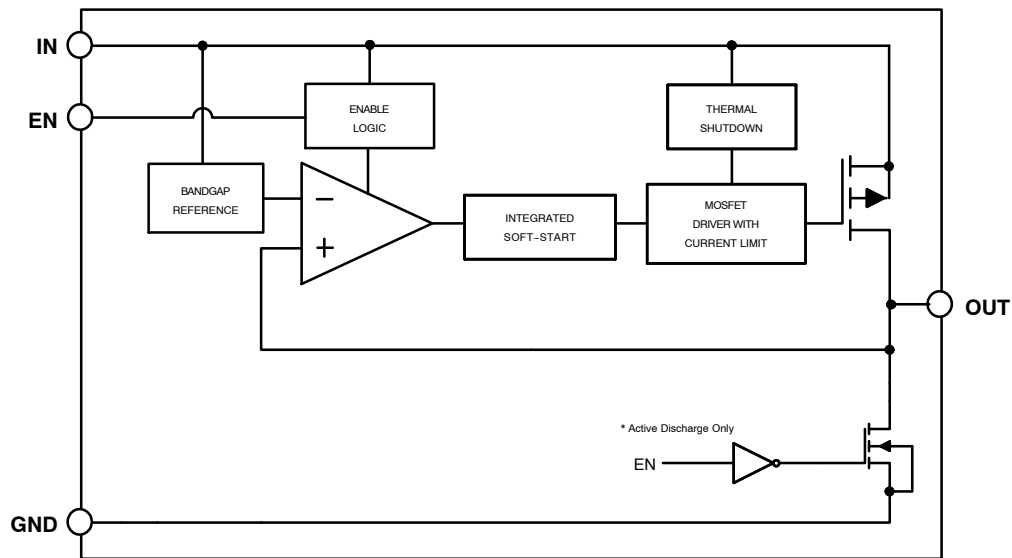

Figure 2. Simplified Schematic Block Diagram

PIN FUNCTION DESCRIPTION

Pin No. CSP4	Pin No. XDFN4	Pin Name	Description
A1	4	IN	Input voltage supply pin
A2	1	OUT	Regulated output voltage. The output should be bypassed with small 1 μ F ceramic capacitor.
B1	3	EN	Chip enable: Applying $V_{EN} < 0.2$ V disables the regulator, Pulling $V_{EN} > 0.7$ V enables the LDO.
B2	2	GND	Common ground connection
-	EPAD	EPAD	Expose pad can be tied to ground plane for better power dissipation

ABSOLUTE MAXIMUM RATINGS

Rating	Symbol	Value	Unit
Input Voltage (Note 1)	V_{IN}	-0.3 V to 6	V
Output Voltage	V_{OUT}	-0.3 to $V_{IN} + 0.3$, max. 6 V	V
Chip Enable Input	V_{CE}	-0.3 to 6 V	V
Output Short Circuit Duration	t_{SC}	unlimited	s
Maximum Junction Temperature	T_J	150	$^{\circ}$ C
Storage Temperature	T_{STG}	-55 to 150	$^{\circ}$ C
ESD Capability, Human Body Model (Note 2)	ESD_{HBM}	2000	V
ESD Capability, Machine Model (Note 2)	ESD_{MM}	200	V

Stresses exceeding those listed in the Maximum Ratings table may damage the device. If any of these limits are exceeded, device functionality should not be assumed, damage may occur and reliability may be affected.

1. Refer to ELECTRICAL CHARACTERISTICS and APPLICATION INFORMATION for Safe Operating Area.

2. This device series incorporates ESD protection and is tested by the following methods:

ESD Human Body Model tested per EIA/JESD22-A114

ESD Machine Model tested per EIA/JESD22-A115

Latchup Current Maximum Rating tested per JEDEC standard: JESD78.

THERMAL CHARACTERISTICS

Rating	Symbol	Value	Unit
Thermal Characteristics, CSP4 (Note 3) Thermal Resistance, Junction-to-Air	$R_{\theta JA}$	108	$^{\circ}$ C/W
Thermal Characteristics, XDFN4 (Note 3) Thermal Resistance, Junction-to-Air		208	

3. Measured according to JEDEC board specification. Detailed description of the board can be found in JESD51-7

NCP110

ELECTRICAL CHARACTERISTICS $-40^{\circ}\text{C} \leq T_J \leq 125^{\circ}\text{C}$; $V_{\text{IN}} = V_{\text{OUT(NOM)}} + 0.3 \text{ V}$ or 1.1 V , whichever is greater; $I_{\text{OUT}} = 1 \text{ mA}$, $C_{\text{IN}} = C_{\text{OUT}} = 1 \mu\text{F}$, unless otherwise noted. $V_{\text{EN}} = 1.0 \text{ V}$. Typical values are at $T_J = +25^{\circ}\text{C}$ (Note 4).

Parameter	Test Conditions	Symbol	Min	Typ	Max	Unit	
Operating Input Voltage		V_{IN}	1.1		5.5	V	
Output Voltage Accuracy	$V_{\text{IN}} = V_{\text{OUT(NOM)}} + 0.3 \text{ V}$ ($V_{\text{IN}} \geq 1.1 \text{ V}$)	$V_{\text{OUT(NOM)}} \leq 1.5 \text{ V}$	V_{OUT}	-30		+30	mV
		$V_{\text{OUT(NOM)}} > 1.5 \text{ V}$		-2		+2	%
Line Regulation	$V_{\text{OUT(NOM)}} + 0.5 \text{ V} \leq V_{\text{IN}} \leq 5.5 \text{ V}$, ($V_{\text{IN}} \geq 1.1 \text{ V}$)	LineReg		0.02		%/V	
Load Regulation	$I_{\text{OUT}} = 1 \text{ mA}$ to 200 mA	LoadReg		0.001		%/mA	
Dropout Voltage (Note 5)	$V_{\text{OUT(NOM)}} = 1.05 \text{ V}$	$I_{\text{OUT}} = 50 \text{ mA}$	V_{DO}		40	70	mV
		$I_{\text{OUT}} = 100 \text{ mA}$			70	130	
	$V_{\text{OUT(NOM)}} = 1.20 \text{ V}$	$I_{\text{OUT}} = 110 \text{ mA}$			60	140	
		$I_{\text{OUT}} = 200 \text{ mA}$			110	190	
	$V_{\text{OUT(NOM)}} = 1.80 \text{ V}$	$I_{\text{OUT}} = 200 \text{ mA}$			65	120	
	$V_{\text{OUT(NOM)}} = 2.80 \text{ V}$	$I_{\text{OUT}} = 200 \text{ mA}$			45	100	
Output Current Limit	$V_{\text{OUT}} = 90\% V_{\text{OUT(NOM)}}$	I_{CL}	225	300		mA	
Short Circuit Current	$V_{\text{OUT}} = 0 \text{ V}$	I_{SC}		300			
Quiescent Current	$I_{\text{OUT}} = 0 \text{ mA}$	I_{Q}		20	25	μA	
Shutdown Current	$V_{\text{EN}} \leq 0.2 \text{ V}$, $V_{\text{IN}} = 1.1 \text{ V}$	I_{DIS}		0.01	1.0	μA	
EN Pin Threshold Voltage	EN Input Voltage "H"	V_{ENH}	0.7			V	
	EN Input Voltage "L"	V_{ENL}			0.2		
EN Pull Down Current	$V_{\text{EN}} = 1.1 \text{ V}$	I_{EN}		0.2	0.5	μA	
Turn-On Time	$C_{\text{OUT}} = 1 \mu\text{F}$, From assertion of V_{EN} to $V_{\text{OUT}} = 95\% V_{\text{OUT(NOM)}}$	t_{ON}		120		μs	
Power Supply Rejection Ratio	$I_{\text{OUT}} = 20 \text{ mA}$, $V_{\text{IN}} = V_{\text{OUT}} + 0.3 \text{ V}$	PSRR		90		dB	
	$f = 100 \text{ Hz}$			95			
	$f = 1 \text{ kHz}$			85			
	$f = 10 \text{ kHz}$ $f = 100 \text{ kHz}$			55			
Output Voltage Noise	$f = 10 \text{ Hz}$ to 100 kHz	V_{N}		8.8		μV_{RMS}	
Thermal Shutdown Threshold	Temperature rising	T_{SDH}		160		$^{\circ}\text{C}$	
	Temperature falling	T_{SDL}		140		$^{\circ}\text{C}$	
Active Output Discharge Resistance	$V_{\text{EN}} < 0.2 \text{ V}$, Version A only	R_{DIS}		280		Ω	

Product parametric performance is indicated in the Electrical Characteristics for the listed test conditions, unless otherwise noted. Product performance may not be indicated by the Electrical Characteristics if operated under different conditions.

4. Performance guaranteed over the indicated operating temperature range by design and/or characterization. Production tested at $T_A = 25^{\circ}\text{C}$. Low duty cycle pulse techniques are used during the testing to maintain the junction temperature as close to ambient as possible.
5. Dropout voltage is characterized when V_{OUT} falls $0.02 \times V_{\text{OUT(NOM)}}$ below $V_{\text{OUT(NOM)}}$.
6. Guaranteed by design.

NCP110

TYPICAL CHARACTERISTICS

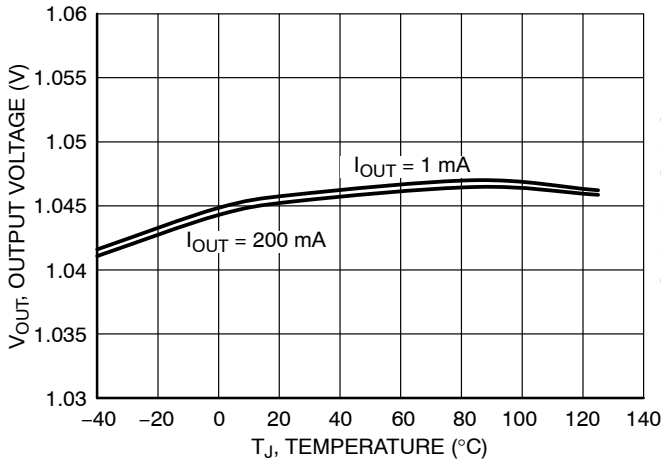

Figure 3. Output Voltage vs. Temperature – $V_{OUT,nom} = 1.05 \text{ V}$ – CSP4

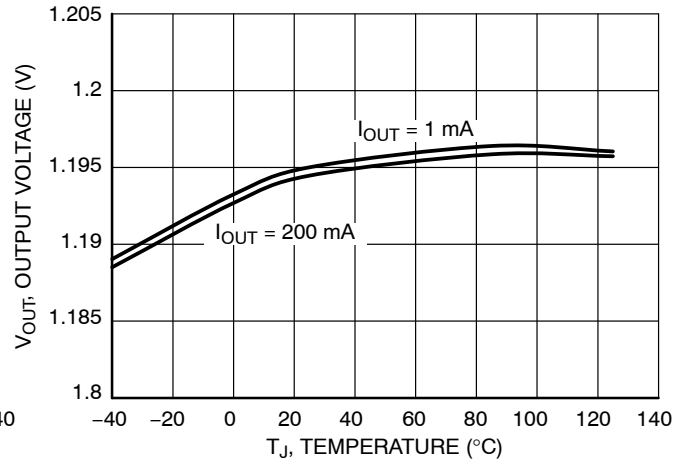

Figure 4. Output Voltage vs. Temperature – $V_{OUT,nom} = 1.2 \text{ V}$ – CSP4

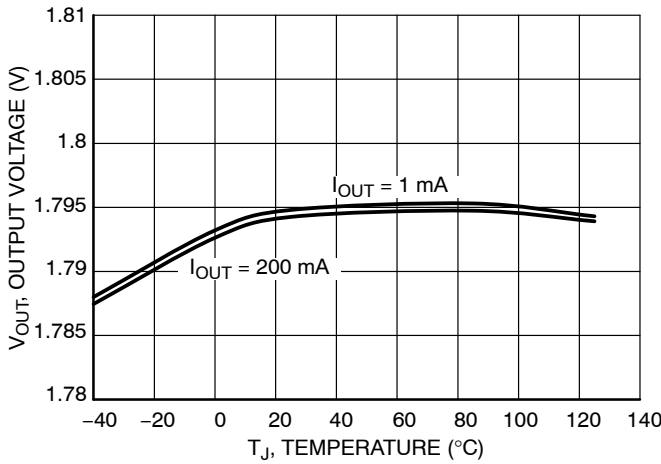

Figure 5. Output Voltage vs. Temperature – $V_{OUT,nom} = 1.8 \text{ V}$ – CSP4

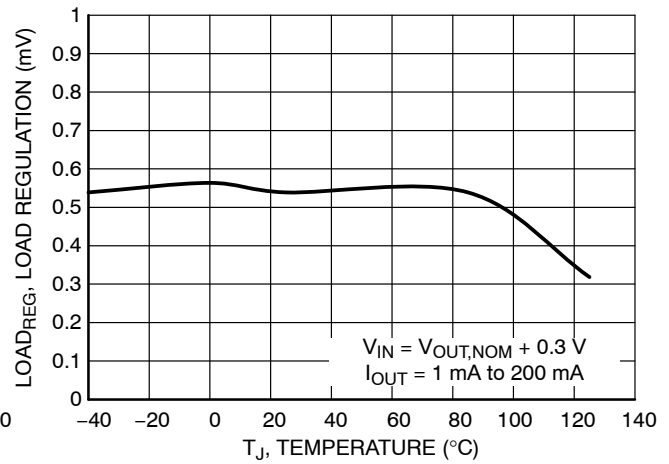

Figure 6. Load Regulation vs. Temperature

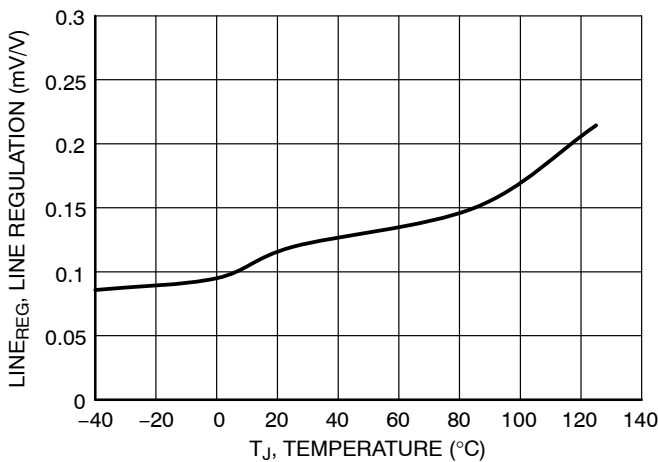

Figure 7. Line Regulation vs. Temperature

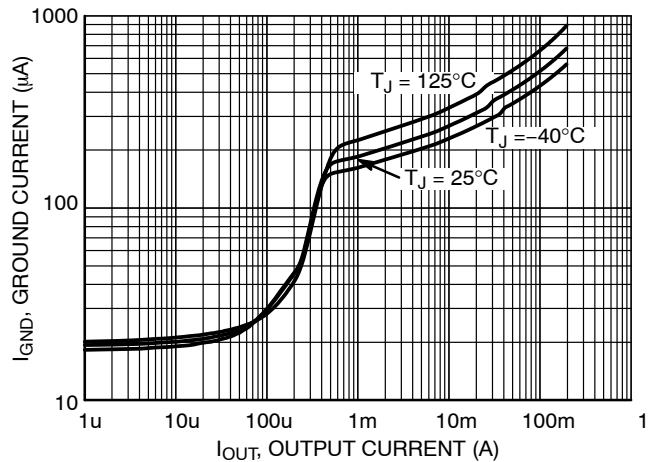

Figure 8. Ground Current vs. Output Current – $V_{OUT,nom} = 1.2 \text{ V}$

NCP110

TYPICAL CHARACTERISTICS

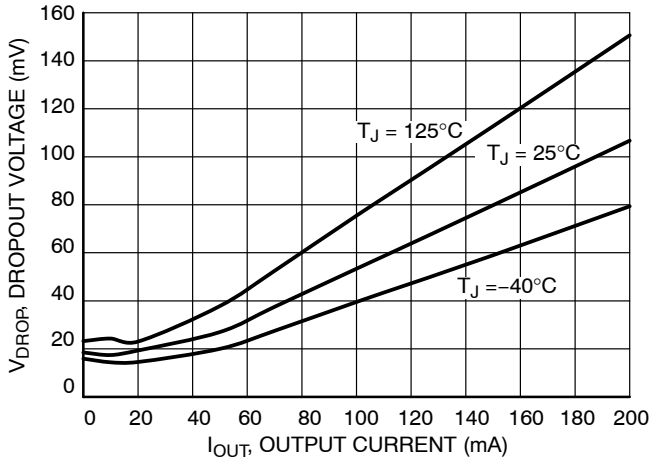

Figure 9. Dropout Voltage vs. Output Current - $V_{OUT,nom} = 1.2\text{ V}$ - CSP4 Package

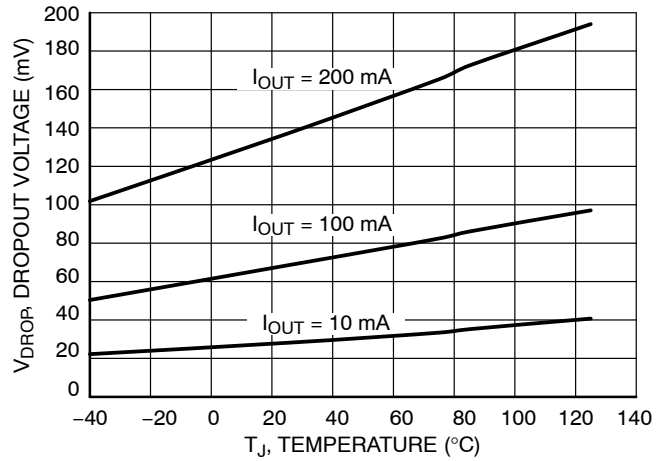

Figure 10. Dropout Voltage vs. Temperature - $V_{OUT,nom} = 1.05\text{ V}$ - CSP4 Package

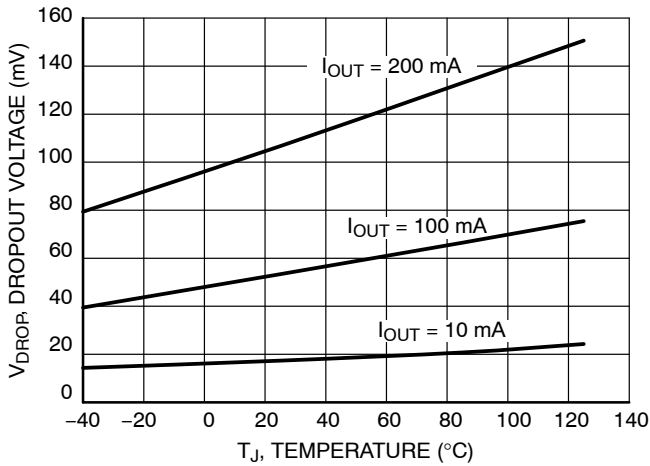

Figure 11. Dropout Voltage vs. Temperature - $V_{OUT,nom} = 1.2\text{ V}$ - CSP4 Package

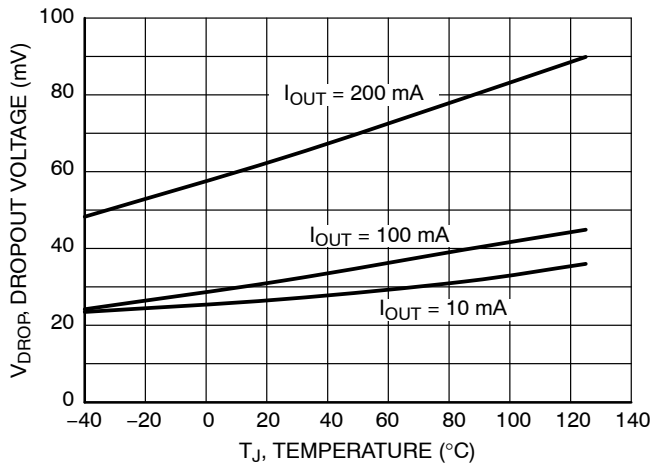

Figure 12. Dropout Voltage vs. Temperature - $V_{OUT,nom} = 1.8\text{ V}$ - CSP4 Package

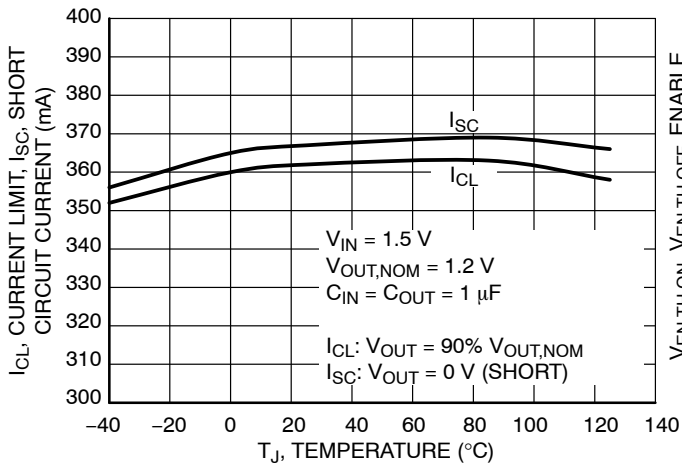

Figure 13. Short-circuit Current vs. Temperature

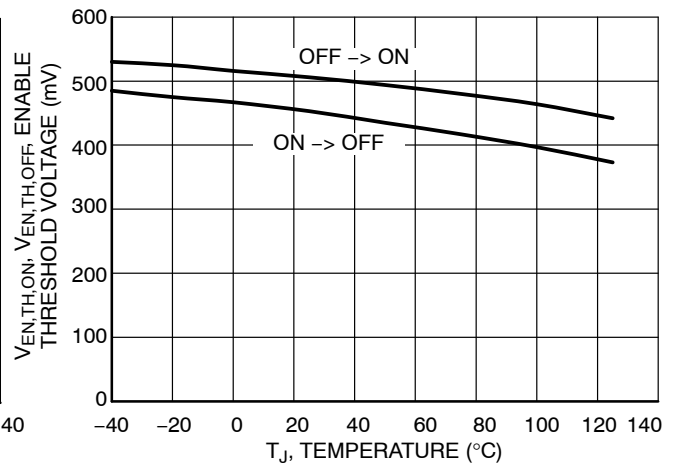

Figure 14. Enable thresholds voltage vs. Temperature

NCP110

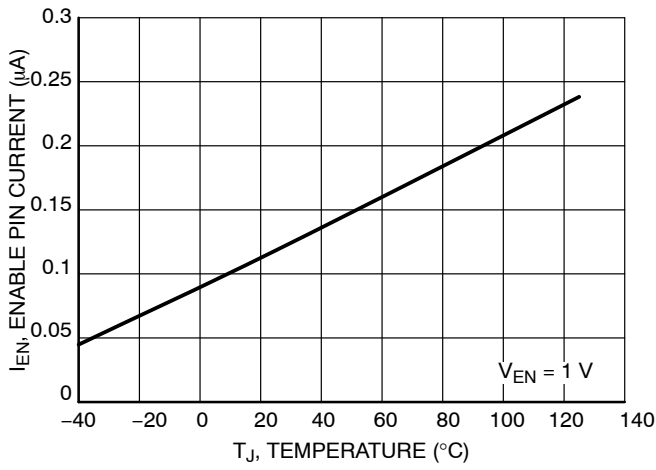

Figure 15. Enable Pin Current vs. Temperature

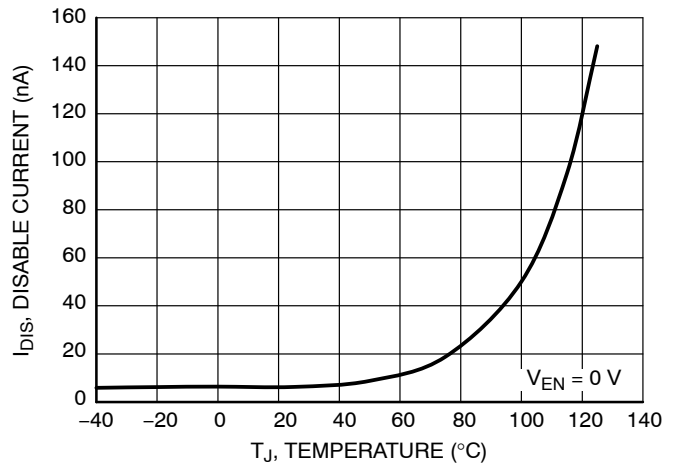

Figure 16. Disable Current vs. Temperature

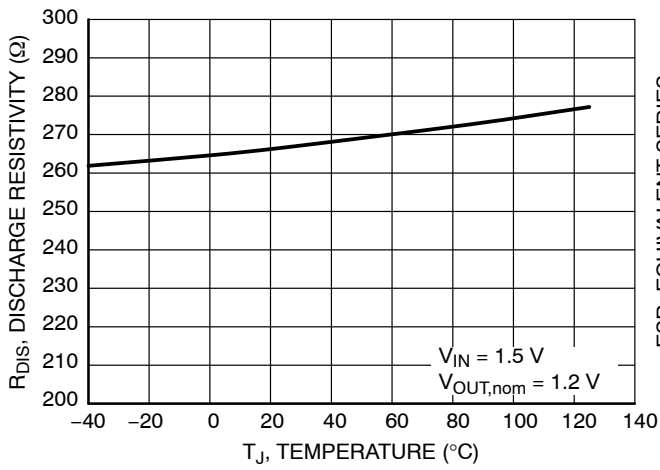

Figure 17. Discharge Resistivity vs. Temperature

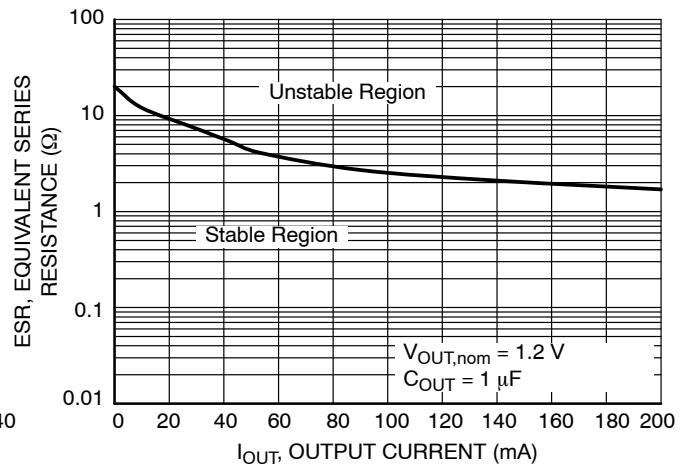

Figure 18. Maximum C_{OUT} ESR Value vs. Output Current

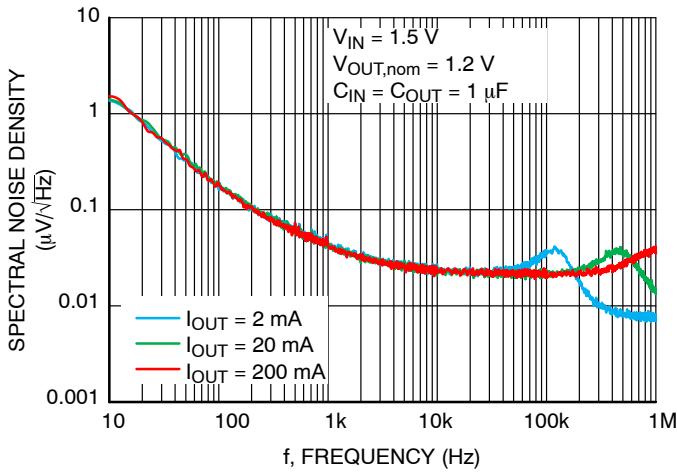

Figure 19. Output Voltage Spectral Noise Density vs. Frequency

I _{OUT} (mA)	RMS Output Noise (μV)	
	10 Hz – 100 kHz	100 Hz – 100 kHz
2	10.01	8.79
20	8.78	7.39
200	8.77	7.44

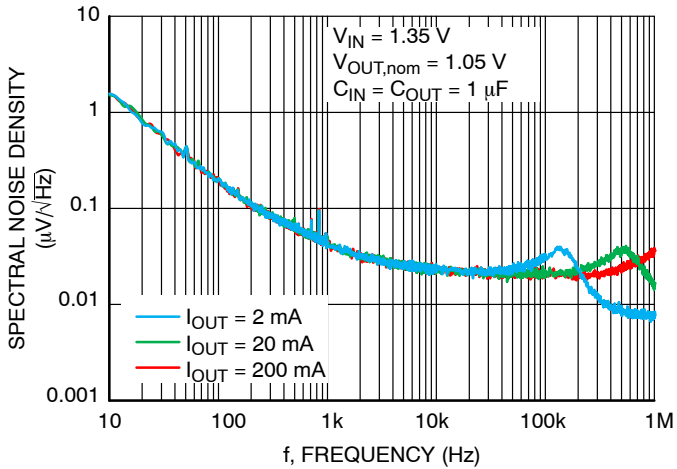

Figure 20. Output Voltage Spectral Noise Density vs. Frequency

I _{OUT} (mA)	RMS Output Noise (μV)	
	10 Hz – 100 kHz	100 Hz – 100 kHz
2	10.01	8.79
20	8.78	7.39
200	8.77	7.44

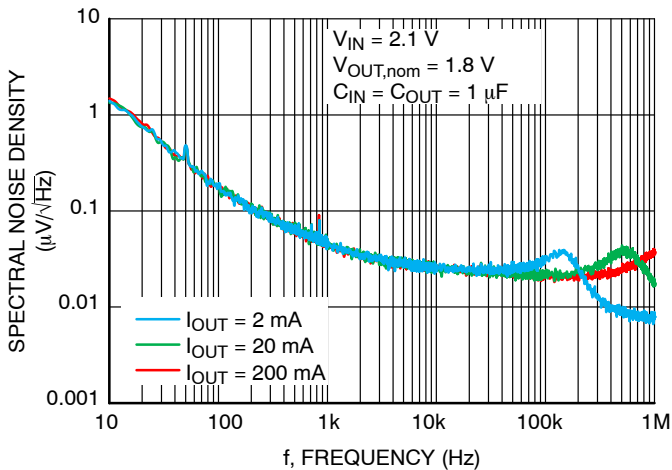

Figure 21. Output Voltage Spectral Noise Density vs. Frequency

I _{OUT} (mA)	RMS Output Noise (μV)	
	10 Hz – 100 kHz	100 Hz – 100 kHz
2	9.88	8.71
20	9.01	7.73
200	9.08	7.70

NCP110

TYPICAL CHARACTERISTICS

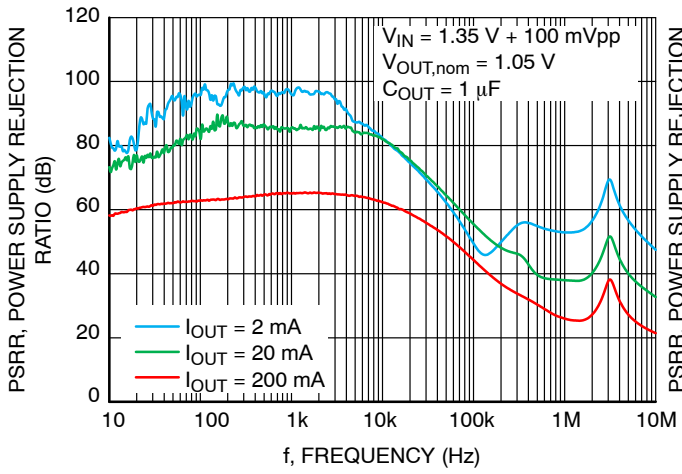

Figure 22. PSRR vs. Frequency

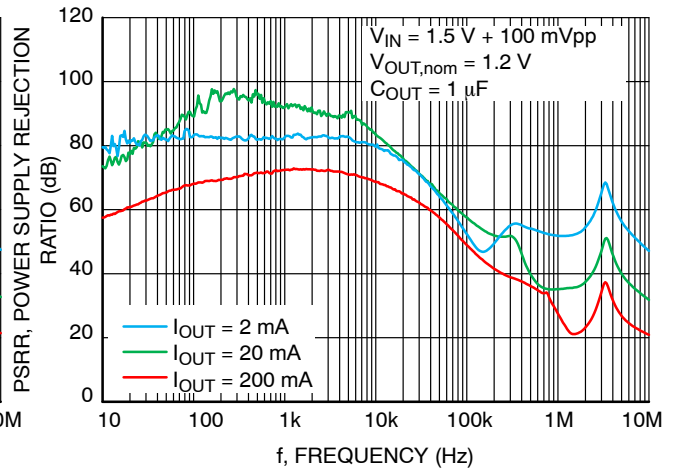

Figure 23. PSRR vs. Frequency

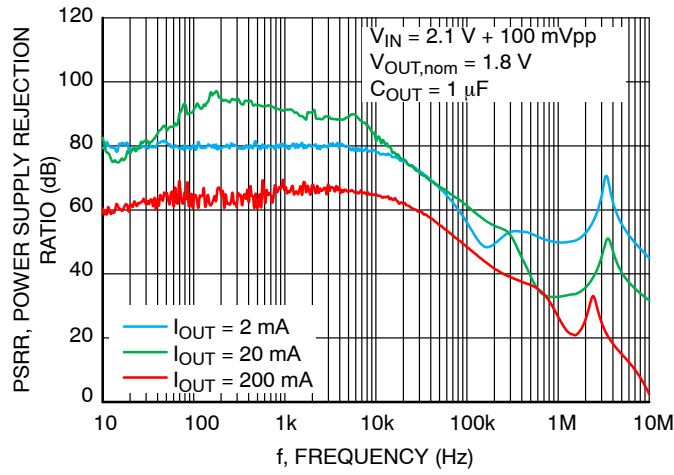

Figure 24. PSRR vs. Frequency

TYPICAL CHARACTERISTICS

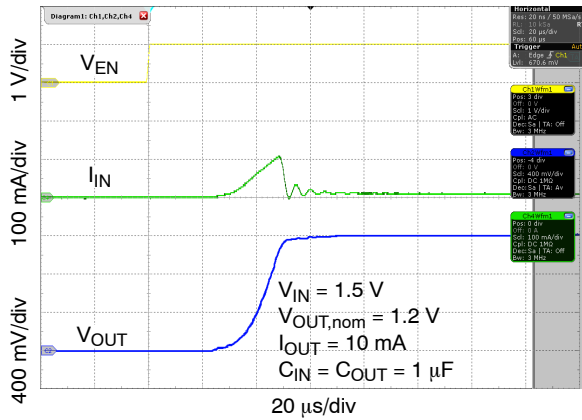

Figure 25. Enable Turn-on Response, $C_{OUT} = 1 \mu\text{F}$, $I_{OUT} = 10 \text{ mA}$

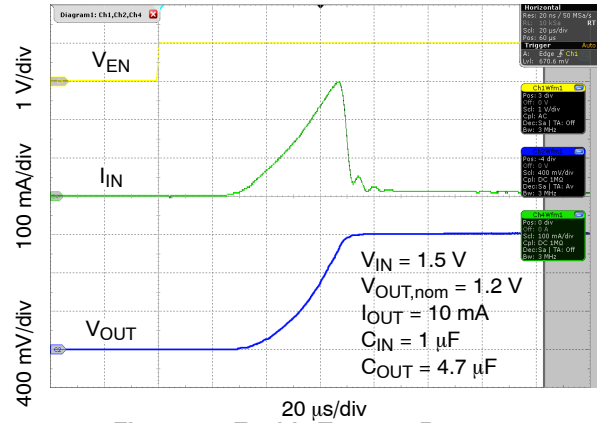

Figure 26. Enable Turn-on Response, $C_{OUT} = 4.7 \mu\text{F}$, $I_{OUT} = 10 \text{ mA}$

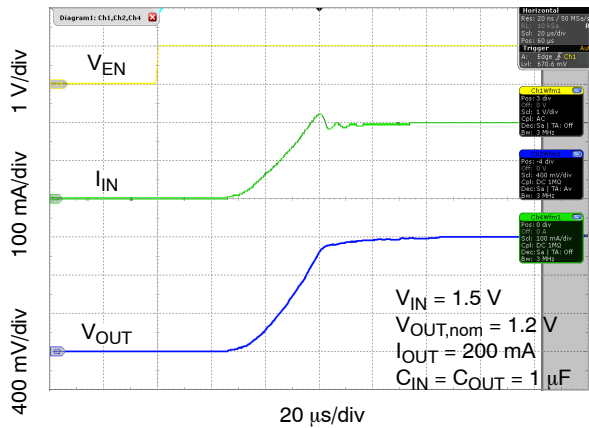

Figure 27. Enable Turn-on Response, $C_{OUT} = 1 \mu\text{F}$, $I_{OUT} = 200 \text{ mA}$

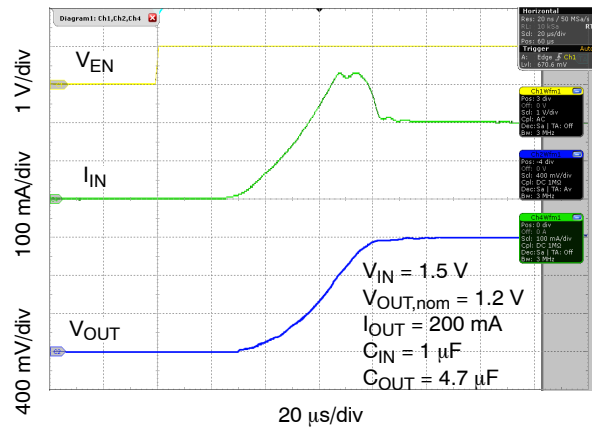

Figure 28. Enable Turn-on Response, $C_{OUT} = 4.7 \mu\text{F}$, $I_{OUT} = 200 \text{ mA}$

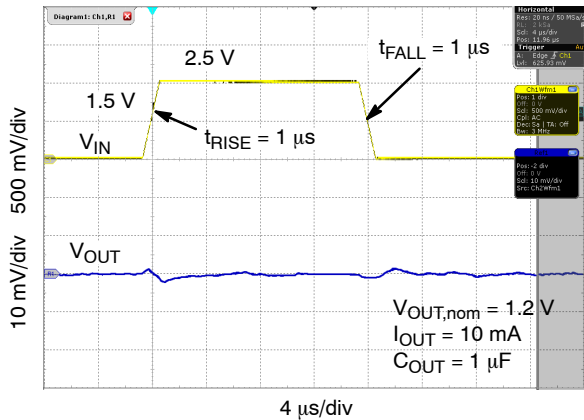

Figure 29. Line Transient Response, $I_{OUT} = 10 \text{ mA}$

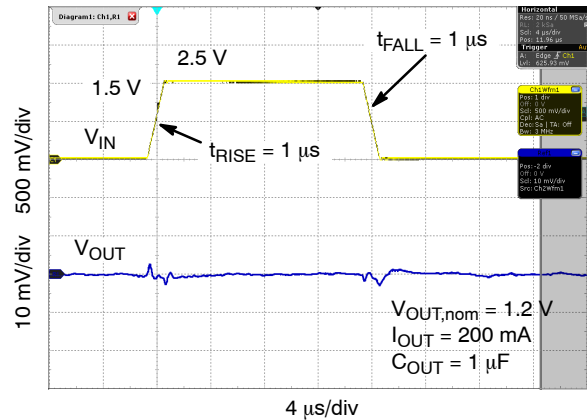

Figure 30. Line Transient Response, $I_{OUT} = 200 \text{ mA}$

TYPICAL CHARACTERISTICS

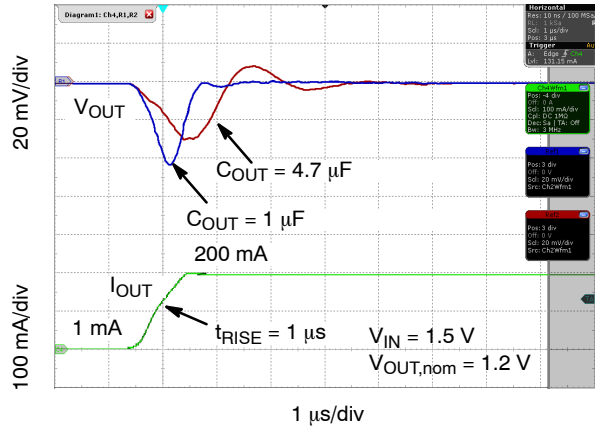

Figure 31. Load Transient Response, $I_{OUT} = 1 \text{ mA}$ to 200 mA

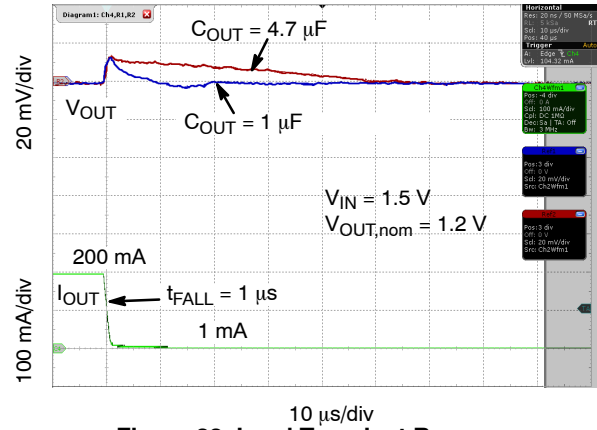

Figure 32. Load Transient Response, $I_{OUT} = 1 \text{ mA}$ to 200 mA

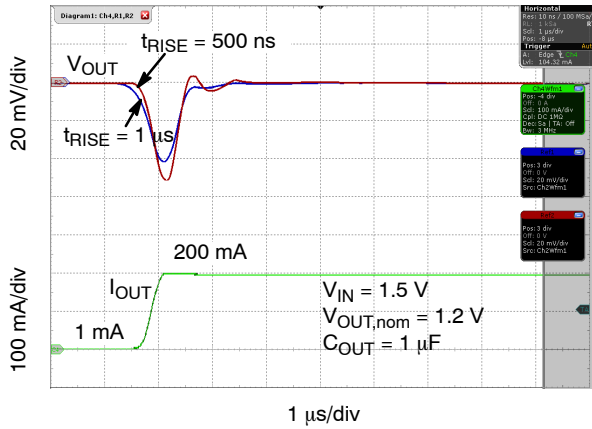

Figure 33. Load Transient Response, $I_{OUT} = 1 \text{ mA}$ to 200 mA

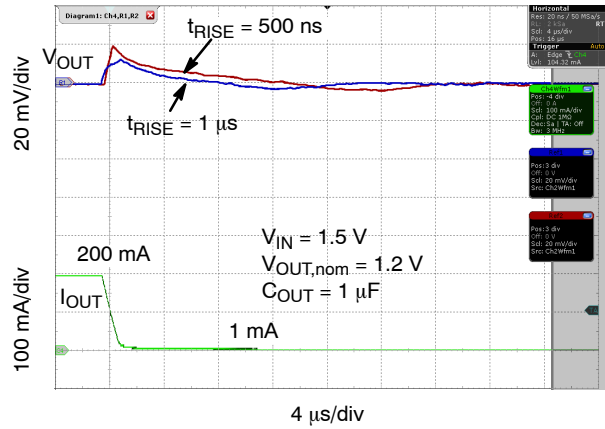

Figure 34. Load Transient Response, $I_{OUT} = 1 \text{ mA}$ to 200 mA

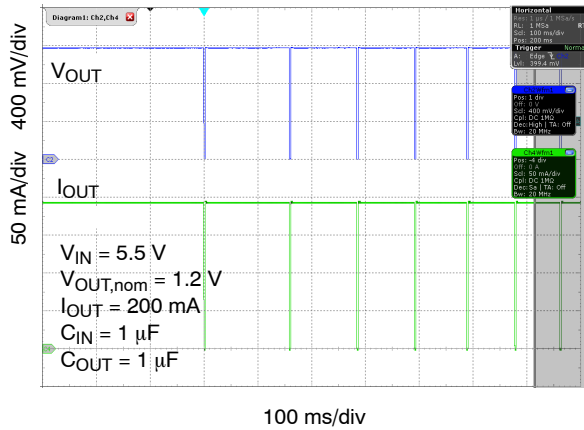

Figure 35. Overheating Protection – TSD

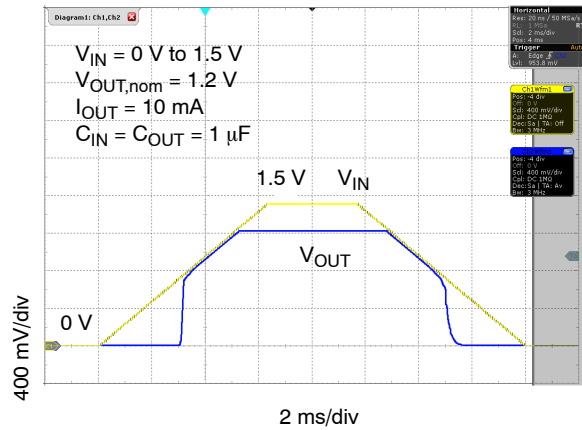

Figure 36. Turn On/Off, Slow Rising V_{IN}

NCP110

TYPICAL CHARACTERISTICS

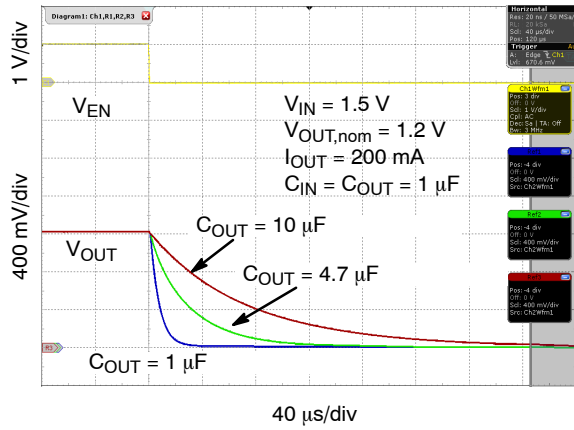

Figure 37. Enable Turn-off Response, Various Output Capacitors

APPLICATIONS INFORMATION

General

The NCP110 is an ultra-low input voltage, ultra-low noise 200 mA low dropout regulator designed to meet the requirements of low voltage RF applications and high performance analog circuits. The NCP110 device provides very high PSRR and excellent dynamic response. In connection with low quiescent current this device is well suitable for battery powered application such as cell phones, tablets and other. The NCP110 is fully protected in case of current overload, output short circuit and overheating.

Input Capacitor Selection (C_{IN})

Input capacitor connected as close as possible is necessary for ensure device stability. The X7R or X5R capacitor should be used for reliable performance over temperature range. The value of the input capacitor should be 1 μ F or greater to ensure the best dynamic performance. This capacitor will provide a low impedance path for unwanted AC signals or noise modulated onto constant input voltage. There is no requirement for the ESR of the input capacitor but it is recommended to use ceramic capacitors for their low ESR and ESL. A good input capacitor will limit the influence of input trace inductance and source resistance during sudden load current changes.

Output decoupling

The NCP110 requires an output capacitor connected as close as possible to the output pin of the regulator. The recommended capacitor value is 1 μ F and X7R or X5R dielectric due to its low capacitance variations over the specified temperature range. The NCP110 is designed to remain stable with minimum effective capacitance of 0.6 μ F to account for changes with temperature, DC bias and package size. Especially for small package size capacitors such as 0201 the effective capacitance drops rapidly with the applied DC bias. Please refer to Figure 38.

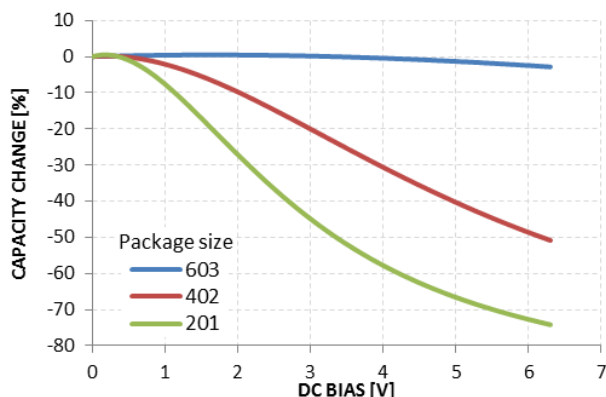

Figure 38. Capacity vs DC Bias Voltage

There is no requirement for the minimum value of Equivalent Series Resistance (ESR) for the C_{OUT} but the maximum value of ESR should be less than 1.6 Ω . Larger

output capacitors and lower ESR could improve the load transient response or high frequency PSRR. It is not recommended to use tantalum capacitors on the output due to their large ESR. The equivalent series resistance of tantalum capacitors is also strongly dependent on the temperature, increasing at low temperature.

Enable Operation

The NCP110 uses the EN pin to enable/disable its device and to deactivate/activate the active discharge function. If the EN pin voltage is <0.2 V the device is guaranteed to be disabled. The pass transistor is turned-off so that there is virtually no current flow between the IN and OUT. The active discharge transistor is active so that the output voltage V_{OUT} is pulled to GND through a 280 Ω resistor. In the disable state the device consumes as low as typ. 10 nA from the V_{IN} . If the EN pin voltage >0.7 V the device is guaranteed to be enabled. The NCP110 regulates the output voltage and the active discharge transistor is turned-off. The EN pin has internal pull-down current source with typ. value of 200 nA which assures that the device is turned-off when the EN pin is not connected. In the case where the EN function isn't required the EN should be tied directly to IN.

Output Current Limit

Output Current is internally limited within the IC to a typical 350 mA. The NCP110 will source this amount of current measured with a voltage drops on the 90% of the nominal V_{OUT} . If the Output Voltage is directly shorted to ground ($V_{OUT} = 0$ V), the short circuit protection will limit the output current to 360 mA (typ). The current limit and short circuit protection will work properly over whole temperature range and also input voltage range. There is no limitation for the short circuit duration.

Thermal Shutdown

When the die temperature exceeds the Thermal Shutdown threshold (TSD – 160°C typical), Thermal Shutdown event is detected and the device is disabled. The IC will remain in this state until the die temperature decreases below the Thermal Shutdown Reset threshold (TSDU – 140°C typical). Once the IC temperature falls below the 140°C the LDO is enabled again. The thermal shutdown feature provides the protection from a catastrophic device failure due to accidental overheating. This protection is not intended to be used as a substitute for proper heat sinking.

Power Dissipation

As power dissipated in the NCP110 increases, it might become necessary to provide some thermal relief. The maximum power dissipation supported by the device is dependent upon board design and layout. Mounting pad configuration on the PCB, the board material, and the ambient temperature affect the rate of junction temperature

NCP110

rise for the part. The maximum power dissipation the NCP110 can handle is given by:

$$P_{D(MAX)} = \frac{[125^{\circ}\text{C} - T_A]}{\theta_{JA}} \quad (\text{eq. 1})$$

The power dissipated by the NCP110 for given application conditions can be calculated from the following equations:

$$P_D \approx V_{IN} \cdot I_{GND} + I_{OUT}(V_{IN} - V_{OUT}) \quad (\text{eq. 2})$$

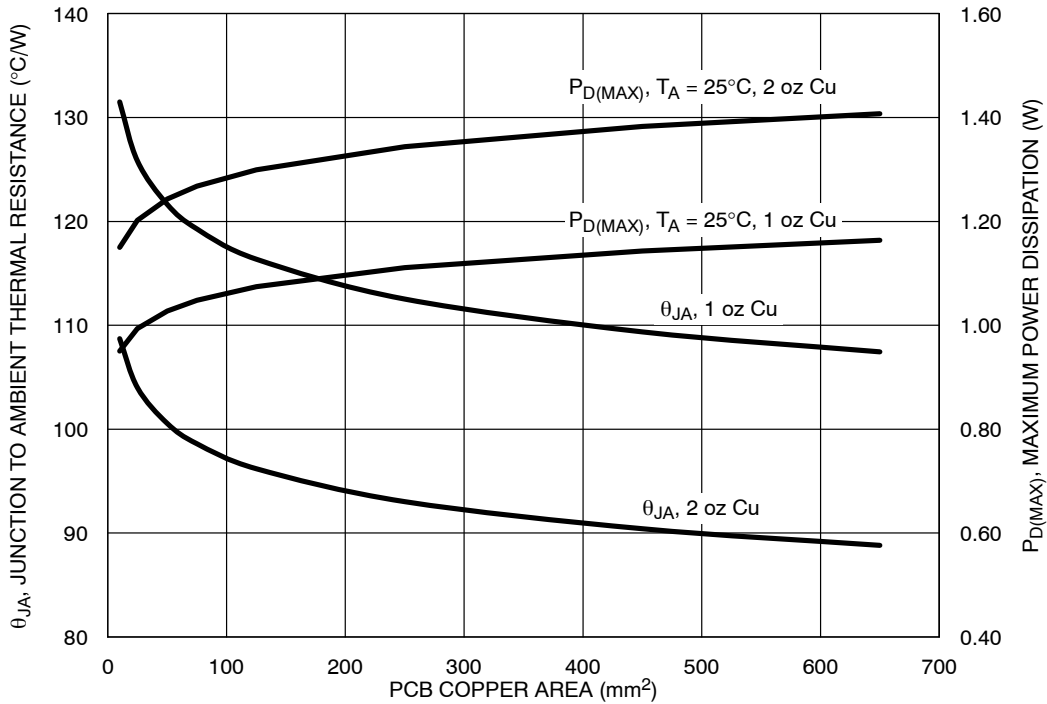

Figure 39. θ_{JA} and P_D (MAX) vs. Copper Area (CSP4)

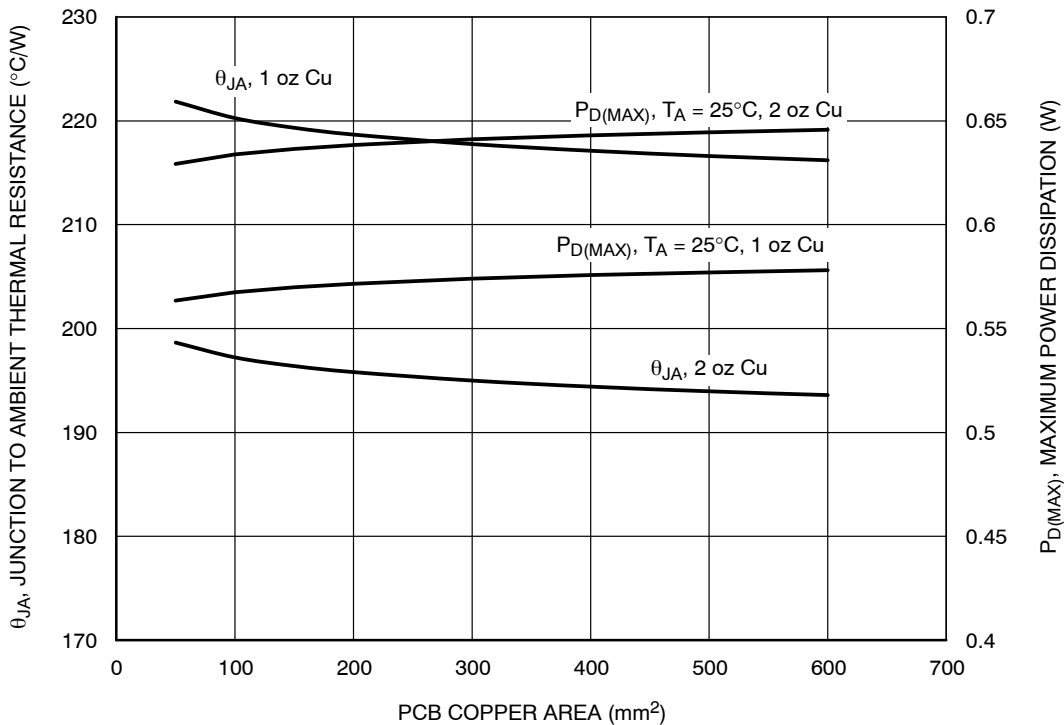

Figure 40. θ_{JA} and P_D (MAX) vs. Copper Area (XDFN4)

NCP110

ORDERING INFORMATION

Device	Nominal Output Voltage	Marking	Rotation	Description	Package	Shipping [†]
NCP110AFCT060T2G	0.60 V	C̄	0°	200 mA, Active Discharge	WLCSP4 CASE 567VS (Pb-Free)	5000 / Tape & Reel
NCP110AFCT080T2G	0.80 V	J	0°			
NCP110AFCT085T2G	0.85 V	Z̄	0°			
NCP110AFCT100T2G	1.00 V	T̄	0°			
NCP110AFCT105T2G	1.05 V	Ā	0°			
NCP110AFCT110T2G	1.10 V	Ḡ	0°			
NCP110AFCT120T2G	1.20 V	F	0°			
NCP110AFCT180T2G	1.80 V	D̄	0°			
NCP110AFCT280T2G	2.80 V	E	0°			

ORDERING INFORMATION

Device	Nominal Output Voltage	Marking	Description	Package	Shipping [†]
NCP110AMX060TBG (Note 7)	0.60 V	FC	200 mA, Active Discharge	XDFN4 CASE 711AJ (Pb-Free)	3000 or 5000 / Tape & Reel (Note 7)
NCP110AMX075TBG	0.75 V	F3			
NCP110AMX080TBG (Note 7)	0.80 V	FJ			
NCP110AMX085TBG (Note 7)	0.85 V	F2			
NCP110AMX100TBG (Note 7)	1.00 V	FG			
NCP110AMX105TBG (Note 7)	1.05 V	FA			
NCP110AMX110TBG (Note 7)	1.10 V	FH			
NCP110AMX120TBG (Note 7)	1.20 V	FF			
NCP110AMX180TBG (Note 7)	1.80 V	FD			
NCP110AMX280TBG (Note 7)	2.80 V	FE			

[†]For information on tape and reel specifications, including part orientation and tape sizes, please refer to our Tape and Reel Packaging Specifications Brochure, [BRD8011/D](#).

7. Product processed after October 1, 2022 are shipped with quantity 5000 units / tape & reel.

MECHANICAL CASE OUTLINE

PACKAGE DIMENSIONS

ON Semiconductor®



SCALE 4:1

WLCSP4, 0.64x0.64x0.33
CASE 567VS
ISSUE O

DATE 25 JAN 2018

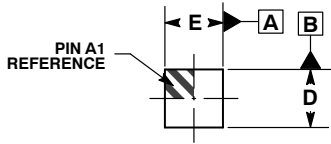

TOP VIEW

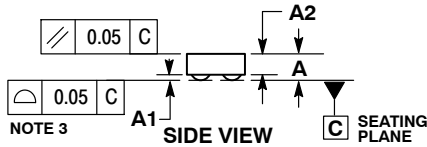

SIDE VIEW

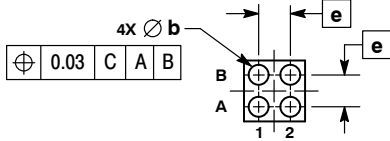

BOTTOM VIEW

RECOMMENDED SOLDERING FOOTPRINT*

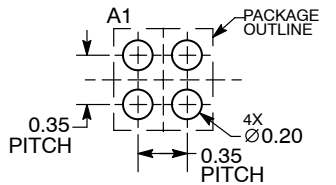

DIMENSIONS: MILLIMETERS

NOTES:

1. DIMENSIONING AND TOLERANCING PER ASME Y14.5M, 1994.
2. CONTROLLING DIMENSION: MILLIMETERS.
3. COPLANARITY APPLIES TO SPHERICAL CROWNS OF SOLDER BALLS.

DIM	MILLIMETERS		
	MIN	NOM	MAX
A	---	---	0.33
A1	0.04	0.06	0.08
A2	0.23 REF		
b	0.180	0.200	0.220
D	0.610	0.640	0.670
E	0.610	0.640	0.670
e	0.35 BSC		

GENERIC MARKING DIAGRAM*



X = Specific Device Code
M = Month

*This information is generic. Please refer to device data sheet for actual part marking. Pb-Free indicator, "G" or microdot "▪", may or may not be present. Some products may not follow the Generic Marking.

*For additional information on our Pb-Free strategy and soldering details, please download the ON Semiconductor Soldering and Mounting Techniques Reference Manual, SOLDERRM/D.

DOCUMENT NUMBER:	98AON82946G	Electronic versions are uncontrolled except when accessed directly from the Document Repository. Printed versions are uncontrolled except when stamped "CONTROLLED COPY" in red.
DESCRIPTION:	WLCSP4, 0.64X0.64X0.33	PAGE 1 OF 1

ON Semiconductor and are trademarks of Semiconductor Components Industries, LLC dba ON Semiconductor or its subsidiaries in the United States and/or other countries. ON Semiconductor reserves the right to make changes without further notice to any products herein. ON Semiconductor makes no warranty, representation or guarantee regarding the suitability of its products for any particular purpose, nor does ON Semiconductor assume any liability arising out of the application or use of any product or circuit, and specifically disclaims any and all liability, including without limitation special, consequential or incidental damages. ON Semiconductor does not convey any license under its patent rights nor the rights of others.

MECHANICAL CASE OUTLINE PACKAGE DIMENSIONS



XDFN4 1.0x1.0, 0.65P
CASE 711AJ
ISSUE C

DATE 08 MAR 2022



NOTES:

1. DIMENSIONING AND TOLERANCING PER ASME Y14.5M, 1994.
2. CONTROLLING DIMENSION: MILLIMETERS
3. DIMENSION *b* APPLIES TO THE PLATED TERMINALS AND IS MEASURED BETWEEN 0.15 AND 0.20 FROM THE TERMINAL TIPS.
4. COPLANARITY APPLIES TO THE EXPOSED PAD AS WELL AS THE TERMINALS.

DIM	MILLIMETERS		
	MIN	NOM	MAX
A	0.33	0.38	0.43
A1	0.00	---	0.05
A3	0.10 REF		
<i>b</i>	0.15	0.20	0.25
<i>b</i> 2	0.02	0.07	0.12
D	0.90	1.00	1.10
D2	0.43	0.48	0.53
E	0.90	1.00	1.10
<i>e</i>	0.65 BSC		
L	0.20		0.30
L2	0.07		0.17

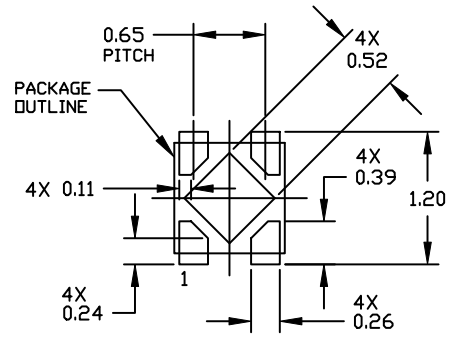
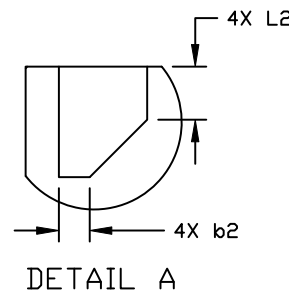
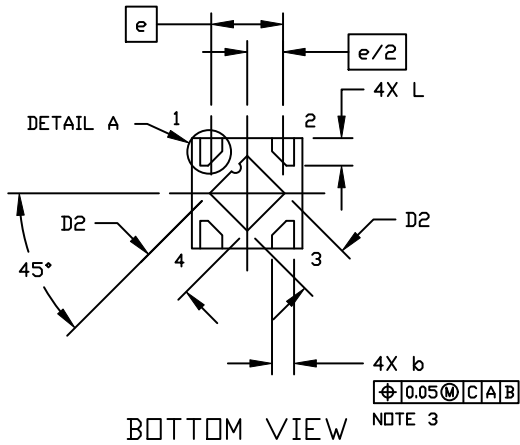

**RECOMMENDED
MOUNTING FOOTPRINT**

* FOR ADDITIONAL INFORMATION ON OUR Pb-FREE STRATEGY AND SOLDERING DETAILS, PLEASE DOWNLOAD THE ONSEMI SOLDERING AND MOUNT TECHNIQUES REFERENCE MANUAL, SOLDERRM/D

GENERIC MARKING DIAGRAM*

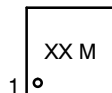

XX = Specific Device Code
M = Date Code

*This information is generic. Please refer to device data sheet for actual part marking. Pb-Free indicator, "G" or microdot "•", may or may not be present. Some products may not follow the Generic Marking.

DOCUMENT NUMBER:	98AON67179E	Electronic versions are uncontrolled except when accessed directly from the Document Repository. Printed versions are uncontrolled except when stamped "CONTROLLED COPY" in red.
DESCRIPTION:	XDFN4, 1.0X1.0, 0.65P	PAGE 1 OF 1

onsemi and ONSEMI are trademarks of Semiconductor Components Industries, LLC dba onsemi or its subsidiaries in the United States and/or other countries. onsemi reserves the right to make changes without further notice to any products herein. onsemi makes no warranty, representation or guarantee regarding the suitability of its products for any particular purpose, nor does onsemi assume any liability arising out of the application or use of any product or circuit, and specifically disclaims any and all liability, including without limitation special, consequential or incidental damages. onsemi does not convey any license under its patent rights nor the rights of others.

onsemi, **Onsemi**, and other names, marks, and brands are registered and/or common law trademarks of Semiconductor Components Industries, LLC dba "**onsemi**" or its affiliates and/or subsidiaries in the United States and/or other countries. **onsemi** owns the rights to a number of patents, trademarks, copyrights, trade secrets, and other intellectual property. A listing of **onsemi**'s product/patent coverage may be accessed at www.onsemi.com/site/pdf/Patent-Marking.pdf. **onsemi** reserves the right to make changes at any time to any products or information herein, without notice. The information herein is provided "as-is" and **onsemi** makes no warranty, representation or guarantee regarding the accuracy of the information, product features, availability, functionality, or suitability of its products for any particular purpose, nor does **onsemi** assume any liability arising out of the application or use of any product or circuit, and specifically disclaims any and all liability, including without limitation special, consequential or incidental damages. Buyer is responsible for its products and applications using **onsemi** products, including compliance with all laws, regulations and safety requirements or standards, regardless of any support or applications information provided by **onsemi**. "Typical" parameters which may be provided in **onsemi** data sheets and/or specifications can and do vary in different applications and actual performance may vary over time. All operating parameters, including "Typicals" must be validated for each customer application by customer's technical experts. **onsemi** does not convey any license under any of its intellectual property rights nor the rights of others. **onsemi** products are not designed, intended, or authorized for use as a critical component in life support systems or any FDA Class 3 medical devices or medical devices with a same or similar classification in a foreign jurisdiction or any devices intended for implantation in the human body. Should Buyer purchase or use **onsemi** products for any such unintended or unauthorized application, Buyer shall indemnify and hold **onsemi** and its officers, employees, subsidiaries, affiliates, and distributors harmless against all claims, costs, damages, and expenses, and reasonable attorney fees arising out of, directly or indirectly, any claim of personal injury or death associated with such unintended or unauthorized use, even if such claim alleges that **onsemi** was negligent regarding the design or manufacture of the part. **onsemi** is an Equal Opportunity/Affirmative Action Employer. This literature is subject to all applicable copyright laws and is not for resale in any manner.

PUBLICATION ORDERING INFORMATION

LITERATURE FULFILLMENT:

Email Requests to: orderlit@onsemi.com

onsemi Website: www.onsemi.com

TECHNICAL SUPPORT

North American Technical Support:

Voice Mail: 1 800-282-9855 Toll Free USA/Canada

Phone: 011 421 33 790 2910

Europe, Middle East and Africa Technical Support:

Phone: 00421 33 790 2910

For additional information, please contact your local Sales Representative