

Approval Sheet

(產品承認書)

產品名稱 (Product): BT 4.2 Module (Nordic nRF51822)

產品型號 (Model No.): MDBT40 Series (Chip Antenna)

MDBT40-P Series (PCB Antenna)

Advantages of MDBT40 & MDBT40-P Series

1. *Long Working Distance*

MDBT40 Series: *Over 80 meters in open space*

MDBT40-P Series: *Up to 60 meters in open space*

2. *Declaration ID already includes all Nordic applied profiles.*

3. *Granted major regional certificates, including FCC, CE (EU),
TELEC (Japan), SRRC (China), IC (Canada), NCC (Taiwan),
KC (South Korea), RCM (Australia & New Zealand) and ANATEL (Brazil).*

More certifications for MDBT40-P module: see [9 Certification](#).

Index

1.	Overall Introduction	4
1.1	Applications	4
1.2	Features	5
1.3	Profile & Service Information	6
2.	Product Dimension	7
2.1	PCB Dimension & Pin Indication.....	7
2.2	Recommended Layout of Solder Pad	9
2.3	RF Layout Suggestion (aka Keep-Out Area).....	12
2.4	Footprint & Design Guide.....	14
2.5	Pin Assignment.....	15
3.	Main Chip Solution	16
4.	Shipment Packaging Information	17
4.1	Marking on Metal Shield	18
4.2	Tray Info	18
5.	Specification	19
5.1	Industrial Temperature Range.....	19
5.2	Absolute Maximum Ratings	20
5.3	Operation Conditions	20
5.4	Electrical Specifications	21
6.	Block Diagram	27
7.	Antenna	28
7.1	MDBT40 Series	28
7.2	MDBT40-P Series	30
8.	Reference Circuit	31
8.1	nRF51822 Schematic with Internal LDO (Module's Default).....	31
8.2	nRF51822 Schematic with 1.8V Low Voltage Mode.....	32
8.3	nRF51822 Schematic with Internal DC/DC Converter.....	33
9.	Certification	34
9.1	Declaration ID.....	34
9.2	FCC Certificate (USA)	35
9.3	TELEC Certificate (Japan)	37
9.4	NCC Certificate (Taiwan)	38
9.5	CE Test Report (EU)	40
9.6	IC Certificate (Canada)	42

9.7	SRRC Certificate (China).....	43
9.8	KC Certificate (South Korea)	44
9.9	RCM Test Report (Australia & New Zealand)	45
9.10	ANATEL Certificate (Brazil).....	46
9.11	CNC Certificate (Argentina) – MDBT40-P Only.....	47
9.12	IFETEL Certificate (Mexico) – MDBT40-P Only	48
9.13	RoHS & RoHS Report	49
9.14	Reliability Test.....	50
9.15	End-Product Label.....	52
10.	Notes and Cautions	54
11.	Useful Links.....	55
	Full List of Raytac’s BLE Modules.....	56
	Release Note	58

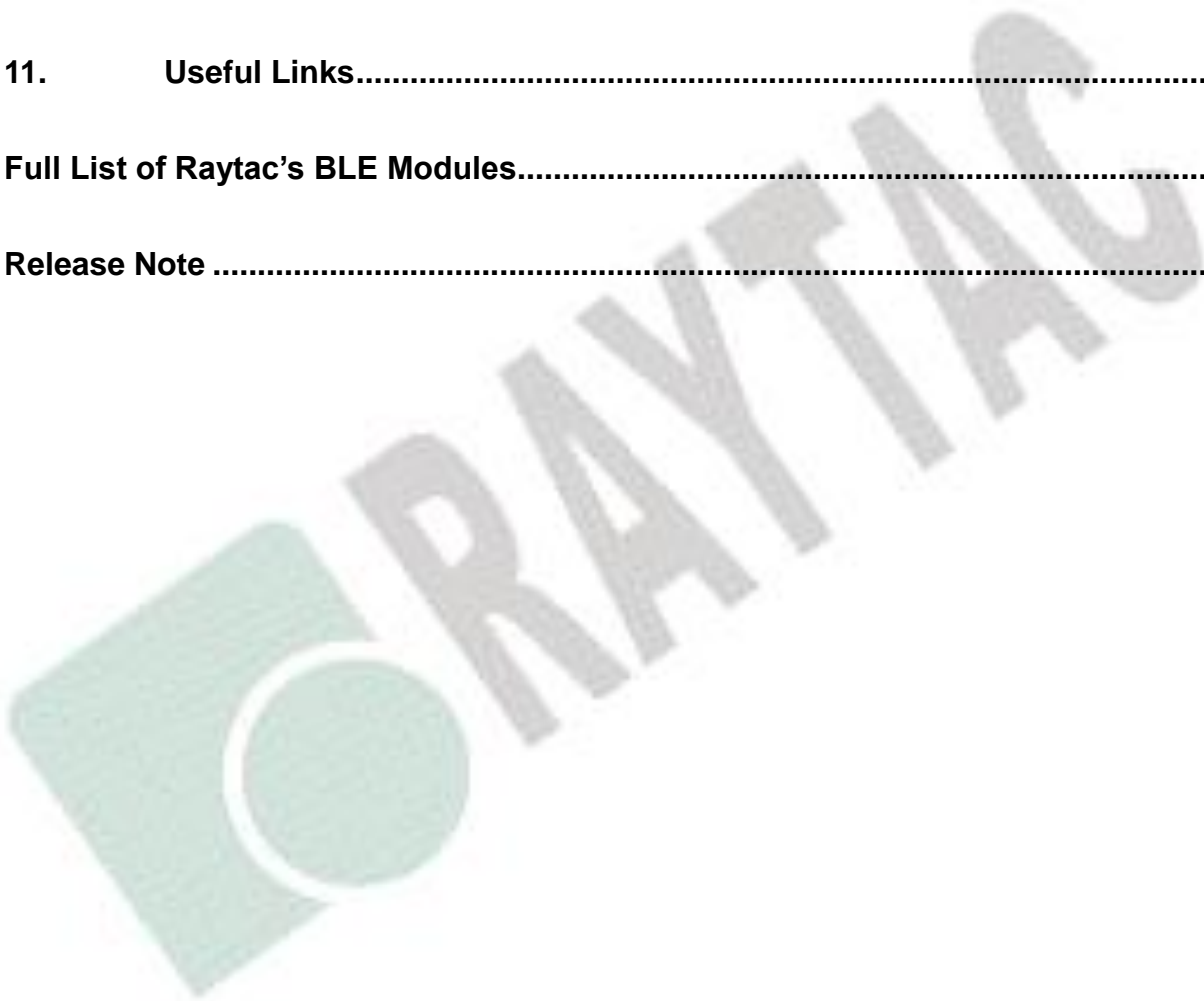

1. Overall Introduction

Raytac's MDBT40 is a BT 4.2, BT 4.1 & BT 4.0 stack (Bluetooth low energy or BLE) module designed based on **Nordic nRF51822 SoC solution**, which incorporates: **GPIO, UART, I2C, SPI, PWM and ADC interfaces** for connecting peripherals and sensors.

The feature of the module:

1. Dual Transmission Mode of BLE & RF 2.4G upon customer preference.
2. Compact size with **(L) 18 x (W) 10 x (H) 3.2 or 2.7 mm**
3. Low power requirements, ultra-low peak, average and idle mode power consumption.
4. Compatible with a large installed base of mobile phones, tablets and computers.
5. Fully coverage of BLE software stack . See [1.3 Profile & Service Information](#)
6. BLE & RF transmission switching may help products to fit all operation system
7. BLE & RF transmission switching may help products fit all kinds of hardware.

1.1 Applications

- . Computer peripherals and I/O devices
 - . Mouse
 - . Keyboard
 - . Multi-touch track pad
- . Interactive entertainment devices
 - . Remote control
 - . 3D Glasses
 - . Gaming controller
- . Personal Area Networks
 - . Health/fitness sensor and monitor devices
 - . Medical devices
 - . Key-fobs + wrist watch
 - . Remote control toys

1.2 Features

- . 2.4GHZ transceiver
 - . -93dbm sensitivity in Bluetooth low energy mode
 - . TX Power -20 to +4dbm in 4dB steps
 - . RSSI (1dB resolution)
- . ARM Cortex – M0 32 bit processor
 - . Serial Wire Debug (SWD)
- . S100 series SoftDevice ready
- . Memory
 - . 256kb embedded flash programmed memory
 - . 16kb RAM or 32kb RAM
- . Support for non-concurrent multiprotocol operation
 - . On-air compatibility with nRF24L series
- . Flexible Power Management
 - . Supply voltage range 1.8V to 3.6V
 - . 4.2us wake-up using 16MHz RCOSC
 - . 0.6uA @ 3V OFF mode
 - . 1.2uA @ 3V in OFF mode + 1 region RAM retention
 - . 2.6uA @ 3V ON mode, all blocks IDLE
- . 8/9/10 bit ADC- 8 configurable channels
- . 31 General Purpose I/O Pins
- . One 32 bit and two 16 bit timers with counter mode
- . SPI Master / Slave
- . Two-wire Master (I2C compatible)
- . UART (CTS/RTS)
- . CPU independent Programmable Peripheral Interconnect (PPI)
- . Quadrature Decoder (QDEC)
- . AES HW encryption
- . Real Timer Counter (RTC)

1.3 Profile & Service Information

Profile & Service below are supported by MDBT40 & MDBT40-P.

Profile Description	Service Description
Alert Notification Profile	Alert Notification Service
Blood Pressure Profile	Blood Pressure Service
	Device Information Service
Cycling Speed & Cadence Profile	Cycling Speed & Cadence Service
	Device Information Service
Glucose Profile	Glucose Service
	Device Information Service
Health Thermometer Profile	Health Thermometer Service
	Device Information Service
Heart Rate Profile	Heart Rate Service
	Device Information Service
HID over GATT Profile	HID Service
	Battery Service
Proximity Profile	Link Loss Service
	Immediate Alert Service
	TX Power Service
Running Speed & Cadence Profile	Running Speed & Cadence Service
	Device Information Service
Mesh Profile	Mesh Provisioning Service
	Mesh Proxy Service

2. Product Dimension

2.1 PCB Dimension & Pin Indication

- **MDBT40 Series**

PCB SIZE : (L) 18 x (W) 10 x (H) 3.2 mm

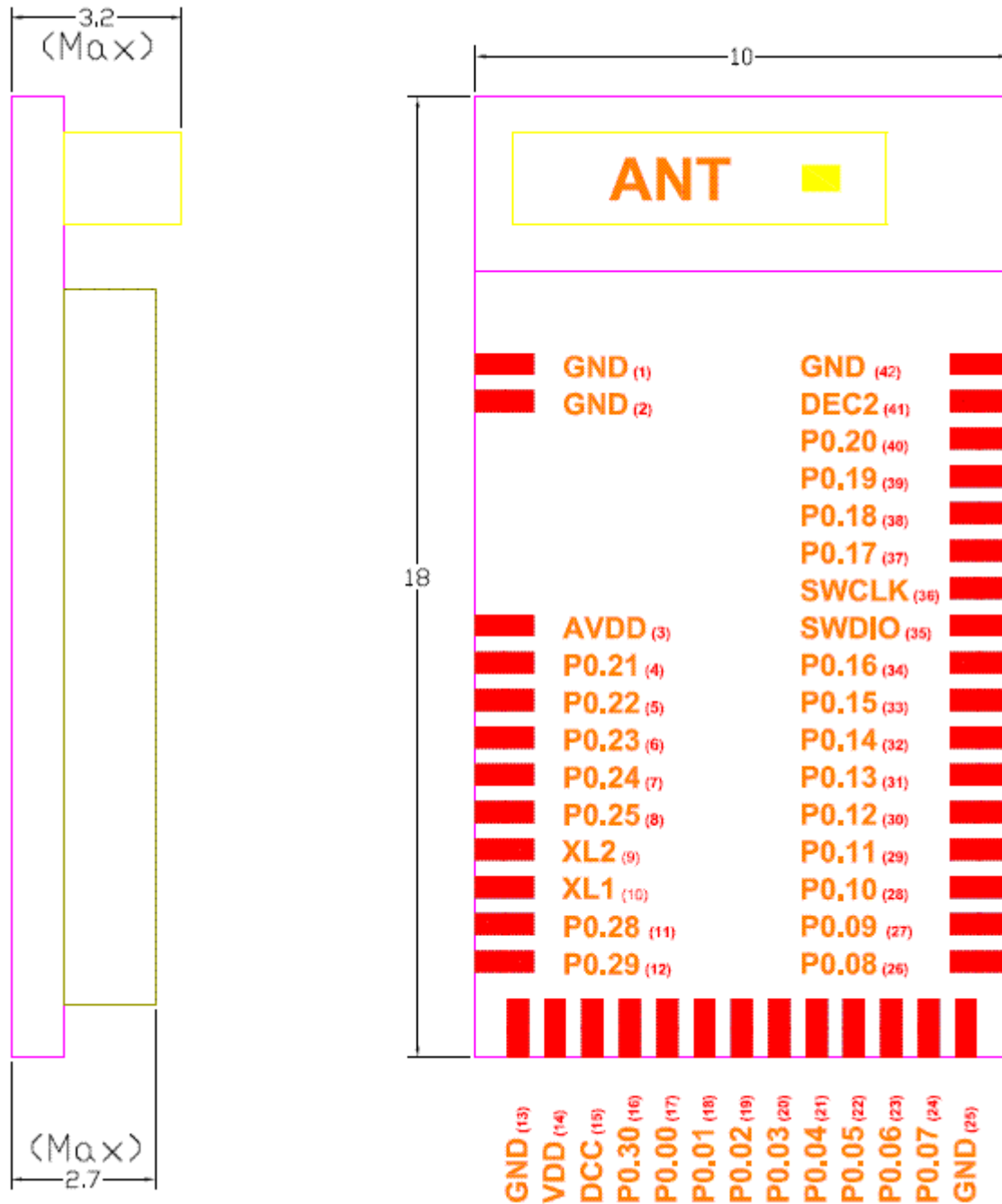

• **MDBT40-P Series**

PCB SIZE : (L) 18 x (W) 10 x (H) 2.7 mm

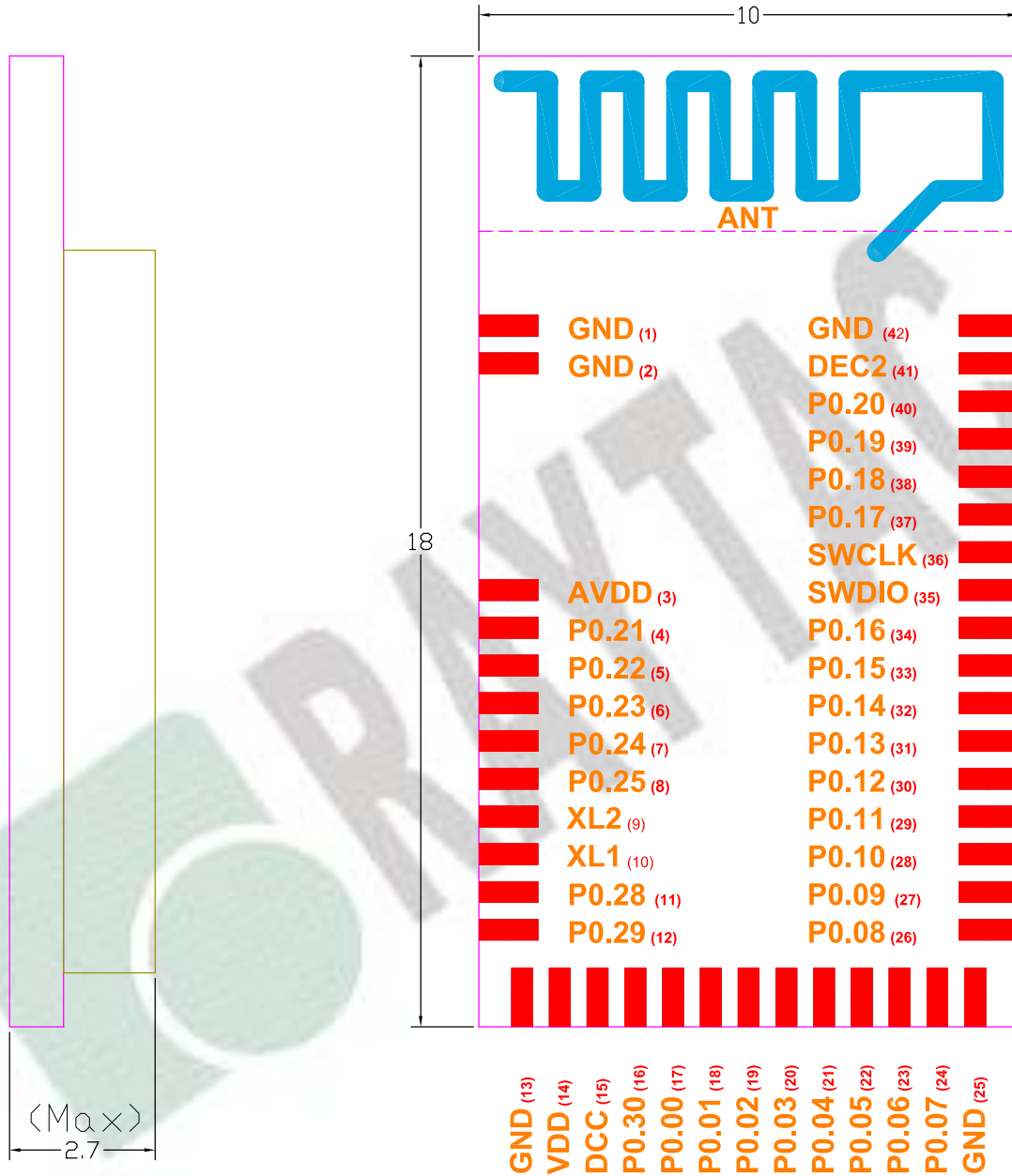

TOP 單位:(mm)

2.2 Recommended Layout of Solder Pad

Graphs are all in Top View, Units in mm.

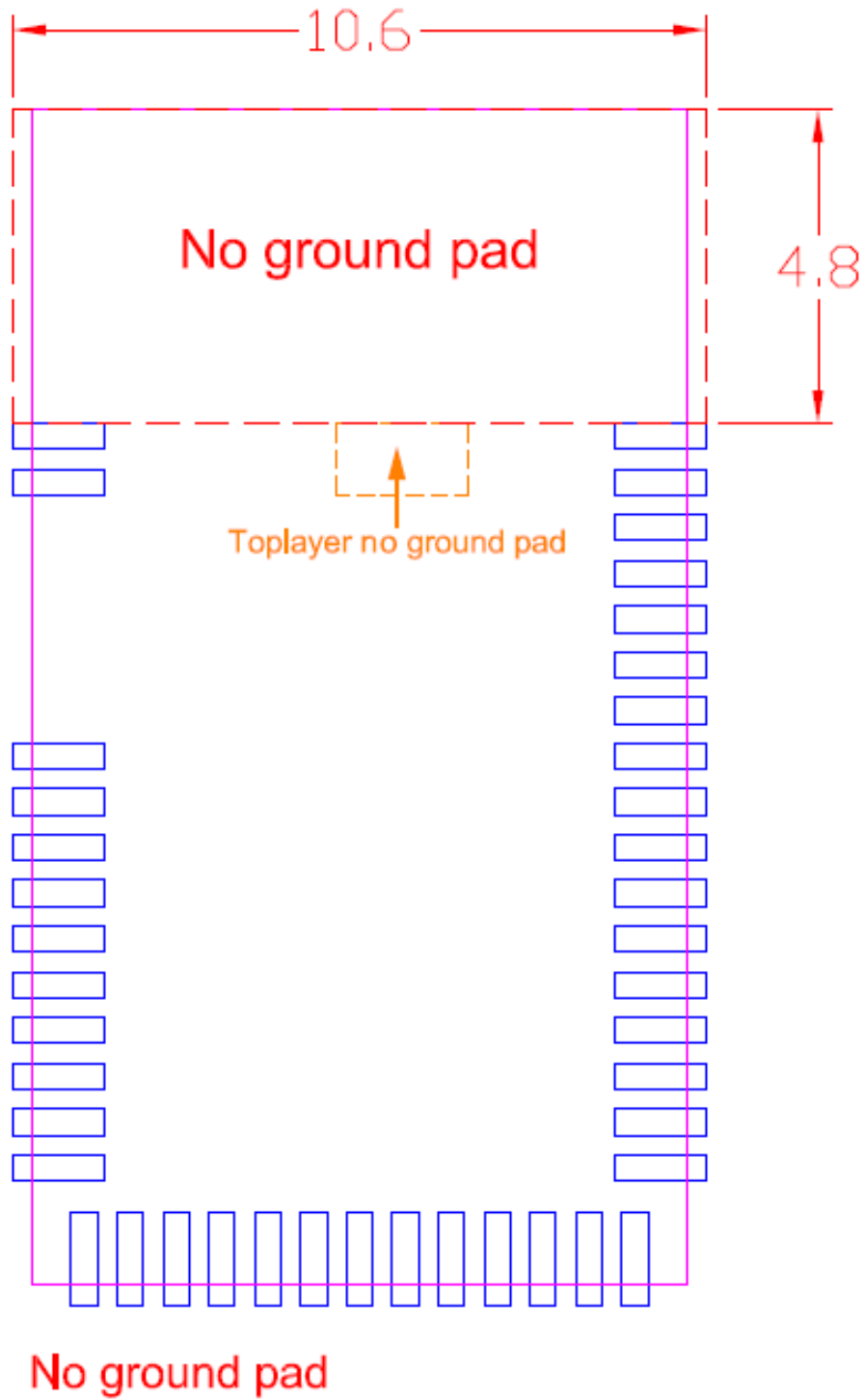

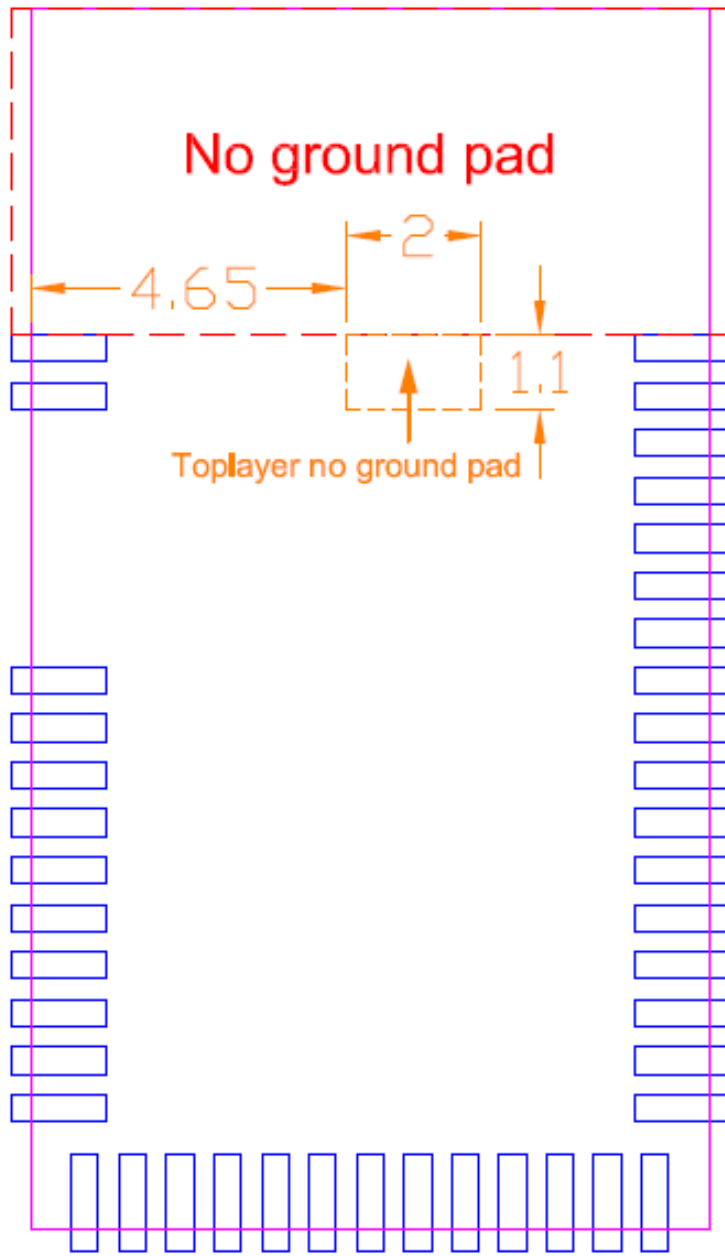

Toplayer no ground pad

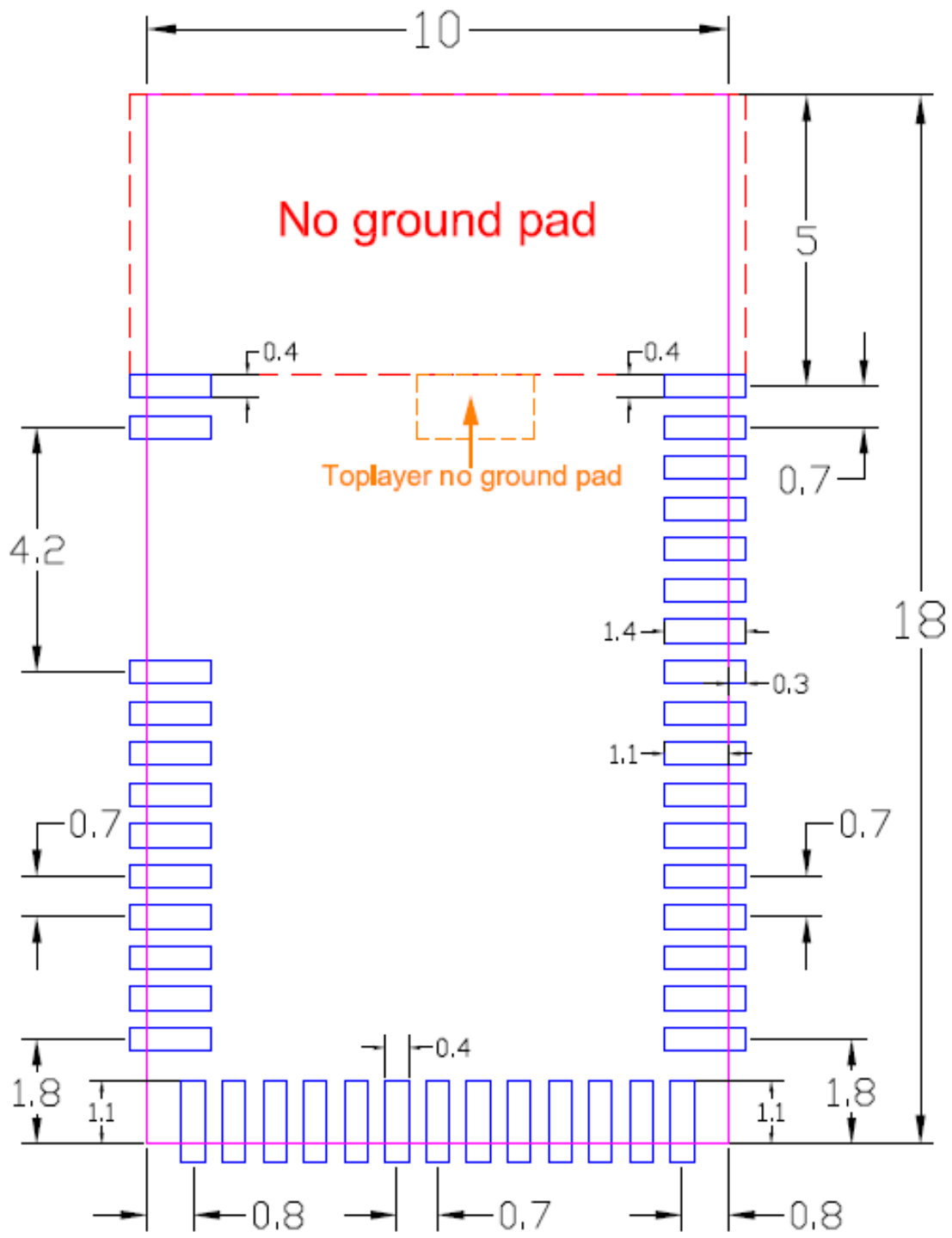

Top View (單位: mm)
recommended solder pad layout

2.3 RF Layout Suggestion (aka Keep-Out Area)

Please follow below instruction to have better wireless performance. Make sure to keep the “No-Ground-Pad” as wider as you can when there is no enough space in your design.

Welcome to send us your layout in PDF for review at service@raytac.com or your contact at Raytac with title “Layout reviewing – MDBT40/MDBT40-P – YOUR company’s name”.

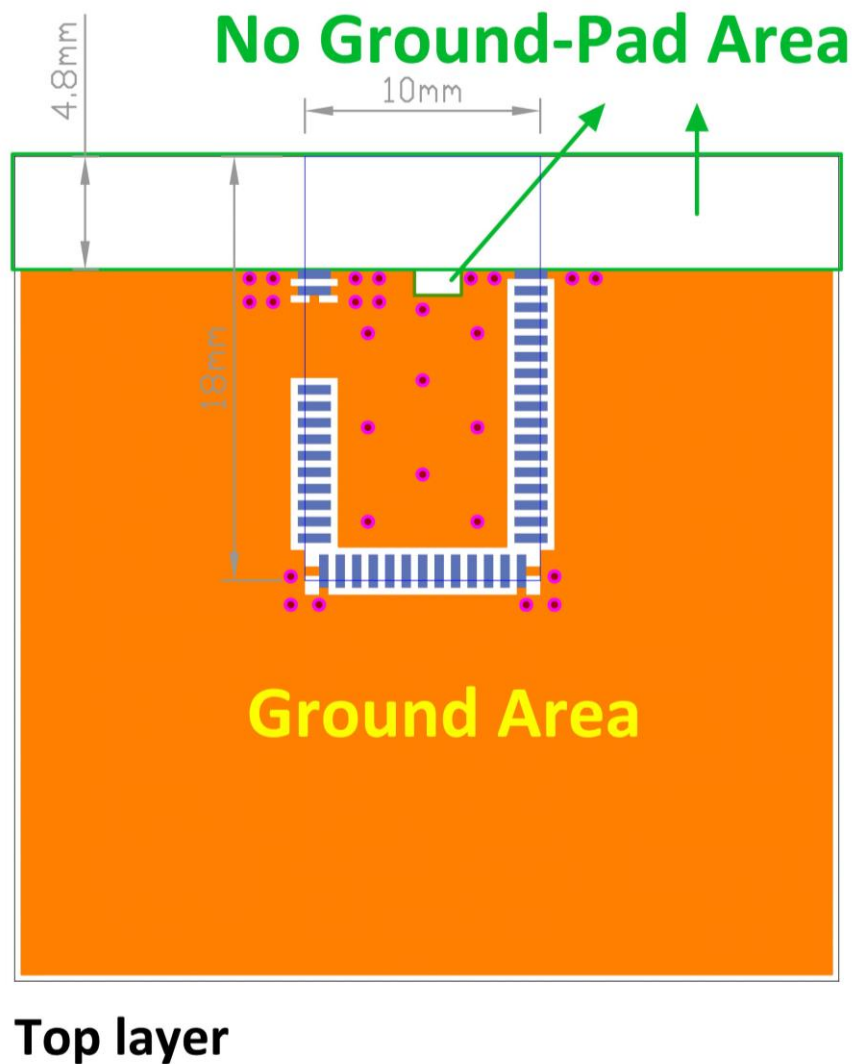

Please add via holes in GROUND area as many as possible, especially around the four corners.

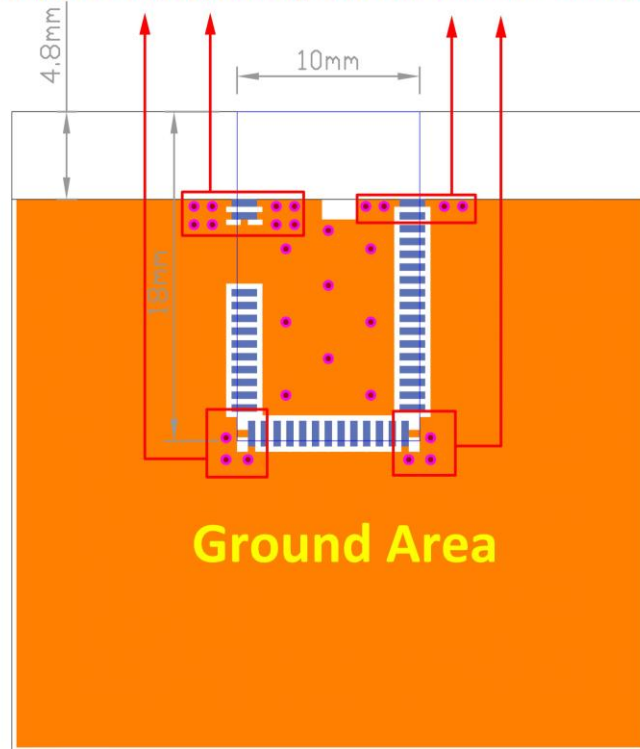

Top layer

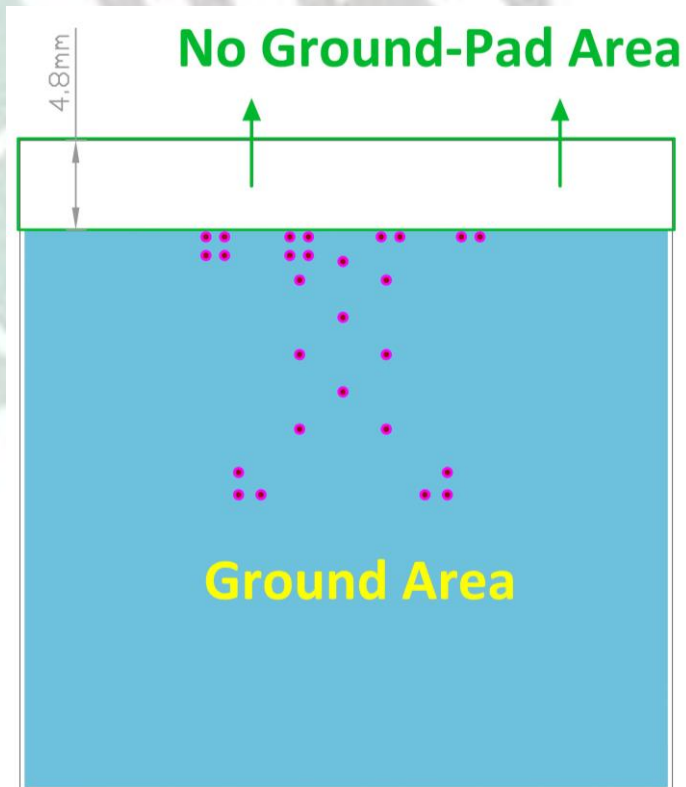

Bottom layer

Examples of “NOT RECOMMENDED” layout

 where should be NO-GROUND area

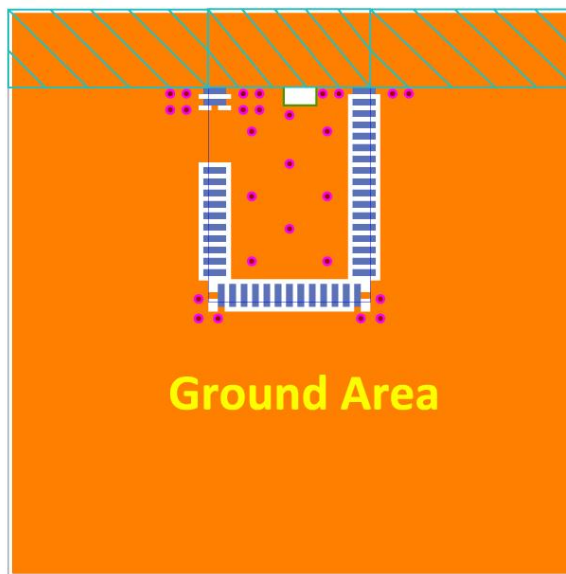

Top layer

 where should be NO-GROUND area

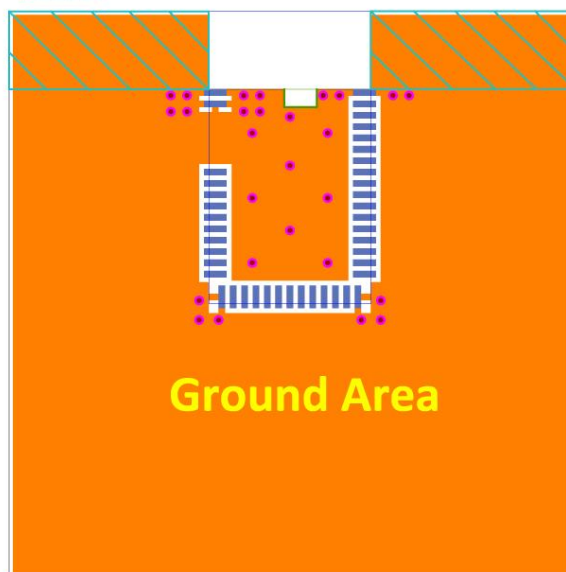

Top layer

2.4 Footprint & Design Guide

Please visit “[Support](#)” page of our website to download. The package includes footprint, 2D/3D drawing, reflow graph and recommended spec for external 32.768khz.

2.5 Pin Assignment

Pin No.	Name	Pin function	Description
(1)(2)	GND	Ground	The pad must be connected to a solid ground plane
(3)	AVDD	Power	Analog power supply
(4)	P0.21	Digital I/O	General-purpose digital I/O
(5)	P0.22	Digital I/O	General-purpose digital I/O
(6)	P0.23	Digital I/O	General-purpose digital I/O
(7)	P0.24	Digital I/O	General-purpose digital I/O
(8)	P0.25	Digital I/O	General-purpose digital I/O
(9)	P0.26	Digital I/O	General-purpose digital I/O
	AIN0	Analog input	ADC input 0
	XL2	Analog output	Connector for 32.768KHz crystal
(10)	P0.27	Digital I/O	General-purpose digital I/O
	AIN1	Analog input	ADC input 1
	XL1	Analog input	Connector for 32.768KHz crystal or external 32.768KHz clock reference
(11)	P0.28	Digital I/O	General-purpose digital I/O
(12)	P0.29	Digital I/O	General-purpose digital I/O
(13)	GND	Ground	The pad must be connected to a solid ground plane
(14)	VDD	Power	Power supply
(15)	DCC	Power	DC/DC output voltage to external LC filter
(16)	P0.30	Digital I/O	General-purpose digital I/O
(17)	P0.00	Digital I/O	General-purpose digital I/O
	AREF0	Analog input	ADC Reference voltage
(18)	P0.01	Digital I/O	General-purpose digital I/O
	AIN2	Analog input	ADC input 2
(19)	P0.02	Digital I/O	General-purpose digital I/O
	AIN3	Analog input	ADC input 3
(20)	P0.03	Digital I/O	General-purpose digital I/O
	AIN4	Analog input	ADC input 4
(21)	P0.04	Digital I/O	General-purpose digital I/O
	AIN5	Analog input	ADC input 5
(22)	P0.05	Digital I/O	General-purpose digital I/O
	AIN6	Analog input	ADC input 6

Pin No.	Name	Pin function	Description
(23)	P0.06	Digital I/O	General-purpose digital I/O
	AIN7	Analog input	ADC input 7
	AREF1	Analog input	ADC Reference voltage
(24)	P0.07	Digital I/O	General-purpose digital I/O
(25)	GND	Ground	The pad must be connected to a solid ground plane
(26)	P0.08	Digital I/O	General-purpose digital I/O
(27)	P0.09	Digital I/O	General-purpose digital I/O
(28)	P0.10	Digital I/O	General-purpose digital I/O
(29)	P0.11	Digital I/O	General-purpose digital I/O
(30)	P0.12	Digital I/O	General-purpose digital I/O
(31)	P0.13	Digital I/O	General-purpose digital I/O
(32)	P0.14	Digital I/O	General-purpose digital I/O
(33)	P0.15	Digital I/O	General-purpose digital I/O
(34)	P0.16	Digital I/O	General-purpose digital I/O
(35)	SWDIO/RESET	Digital I/O	System reset(active low).Also HW debug and flash Programming
(36)	SWDCLK	Digital input	HW debug and flash programming.
(37)	P0.17	Digital I/O	General-purpose digital I/O
(38)	P0.18	Digital I/O	General-purpose digital I/O
(39)	P0.19	Digital I/O	General-purpose digital I/O
(40)	P0.20	Digital I/O	General-purpose digital I/O
(41)	DEC2	Power	Power supply decoupling. Low voltage mode VCC
(42)	GND	Ground	The pad must be connected to a solid ground plane





¹ Digital I/O pad with 5mA source/sink capability.

3. Main Chip Solution

RF IC	Crystal Frequency
Nordic NRF51822/QFN48	16MHZ

16MHz is already inside the module.

4. Shipment Packaging Information

Marking	Model	
Red	MDBT40-256V3	MDBT40-P256V3
		
Yellow	MDBT40-256RV3	MDBT40-P256RV3
		

- Unit Weight of Module:

MDBT40 Series: 0.88 g / pc (± 0.02 g) ; MDBT40-P Series: 0.78 g / pc (± 0.02 g)

- Packaging Type: Anti-Static Tray only

- Minimum Package Quantity (MPQ): 88 pcs per Tray

- Carton Contents: 1,760 pcs per Carton (20 Full Tray + 1 Empty Tray)

- Dimension of Carton: (L) 37 x (W) 21 x (H) 13 cm

- Gross Weight: approx. 3.2 kgs per full carton (contains 1,760 pcs)

4.1 Marking on Metal Shield

Label context on metal shield is as below:



4.2 Tray Info

Anti-static tray is specifically designed for mass production. It can be used directly on SMT automatic machine.

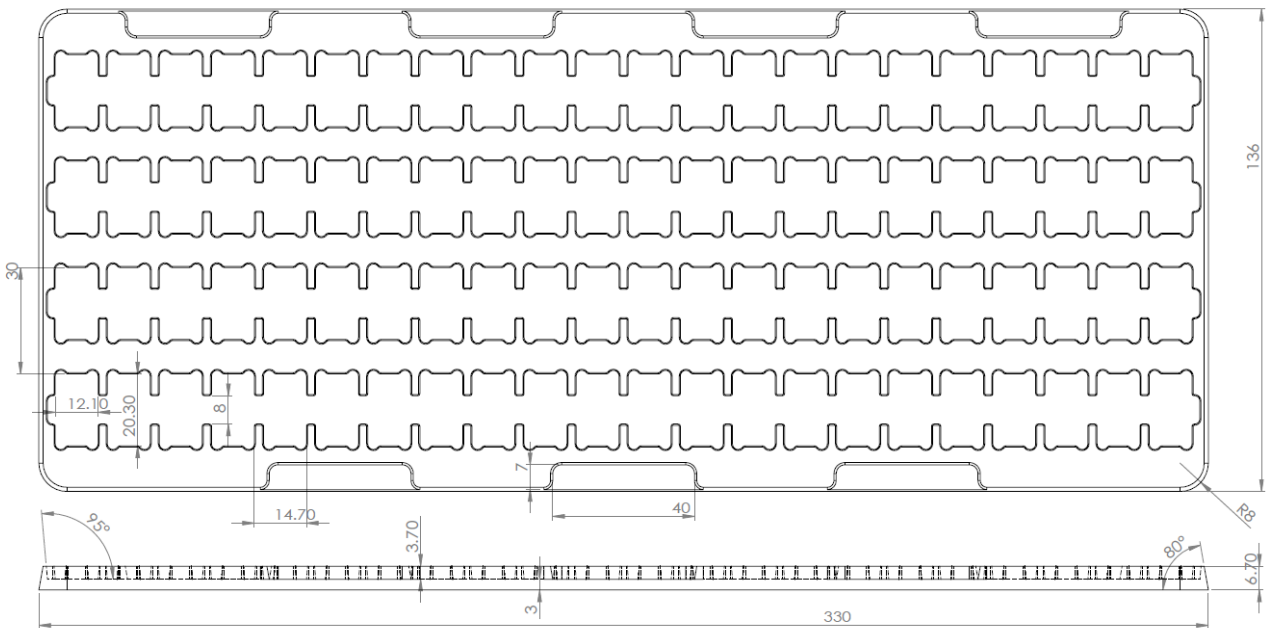

5. Specification

Any technical spec shall refer to Nordic's official documents as final reference.

Below contents are from "[nRF51822 specification for Extended Industrial Temperature range](#)" and "[nRF51822 Product Specification v3.3](#)"

5.1 Industrial Temperature Range

Industrial temperature range is applied in below IC.

nRF51822 variant	Build Code	Raytac Model #
QFAA	Hx0	MDBT40-256V3 MDBT40-P256V3
CEAA	Ex0	MDBT40-n256V3

Operating conditions of supported industrial temperature:

Symbol	Parameter	Notes	Min.	Typ.	Max.	Units
VDD	Supply voltage, internal LDO setup		1.9	3.0	3.6	V
VDD	Supply voltage, DC/DC converter setup		2.1	3.0	3.6	V
T _A	Operating temperature		-40	25	105	°C

Other changes are including:

- (1) 2.4Ghz transceiver: Not supported 1Mbps data rates
- (2) Not support 1.8V low voltage mode

When you use above modules within -25°C to 75°C, please see [5.3 Operation Conditions](#) and [5.4 Electrical Specifications](#) to know its normal operating spec.

5.2 Absolute Maximum Ratings

Symbol	Parameter	Min.	Max.	Unit
Supply voltages				
VDD		-0.3	+3.9	V
DEC2			2	V
VSS			0	V
I/O pin voltage				
VIO		-0.3	VDD + 0.3	V
Environmental QFN48 package				
Storage temperature		-40	+125	°C
MSL	Moisture Sensitivity Level		2	
ESD HBM	Human Body Model		4	kV
ESD CDM	Charged Device Model		750	V
Flash memory				
Endurance		20 000 ¹		write/erase cycles
Retention		10 years at 40 °C 50 years at 25 °C		
Number of times an address can be written between erase cycles			2	times

1. Flash endurance is 20,000 erase cycles. The smallest element of flash that can be written is a 32 bit word.

5.3 Operation Conditions

Symbol	Parameter	Notes	Min.	Typ.	Max.	Units
VDD	Supply voltage, internal LDO setup		1.8	3.0	3.6	V
VDD	Supply voltage, DC/DC converter setup		2.1	3.0	3.6	V
VDD	Supply voltage, low voltage mode setup	1	1.75	1.8	1.95	V
t _{R_VDD}	Supply rise time (0 V to VDD)	2			100	ms
T _A	Operating temperature		-25	25	75	°C

1. DEC2 shall be connected to VDD in this mode.
2. The on-chip power-on reset circuitry may not function properly for rise times outside the specified interval.

5.4 Electrical Specifications

5.4.1 Radio Transceiver

. General Radio Characteristics

Symbol	Description	Note	Min.	Typ.	Max.	Units	Test level
f_{OP}	Operating frequencies.	1 MHz channel spacing.	2400		2483	MHz	N/A
PLL_{res}	PLL programming resolution.			1		MHz	N/A
Δf_{250}	Frequency deviation at 250 kbps.			± 170		kHz	2
Δf_{1M}	Frequency deviation at 1 Mbps.			± 170		kHz	2
Δf_{2M}	Frequency deviation at 2 Mbps.			± 320		kHz	2
Δf_{BLE}	Frequency deviation at BLE.		± 225	± 250	± 275	kHz	4
bps_{FSK}	On-air data rate.		250		2000	kbps	N/A

. Radio Current Consumption

Symbol	Description	Note	Min.	Typ.	Max.	Units	Test level
$I_{TX,+4dBm}$	TX only run current at $P_{OUT} = +4$ dBm.	1		16		mA	4
$I_{TX,0dBm}$	TX only run current at $P_{OUT} = 0$ dBm.	1		10.5		mA	4
$I_{TX,-4dBm}$	TX only run current at $P_{OUT} = -4$ dBm.	1		8		mA	2
$I_{TX,-8dBm}$	TX only run current at $P_{OUT} = -8$ dBm.	1		7		mA	2
$I_{TX,-12dBm}$	TX only run current at $P_{OUT} = -12$ dBm.	1		6.5		mA	2
$I_{TX,-16dBm}$	TX only run current at $P_{OUT} = -16$ dBm.	1		6		mA	2
$I_{TX,-20dBm}$	TX only run current at $P_{OUT} = -20$ dBm.	1		5.5		mA	2
$I_{TX,-30dBm}$	TX only run current at $P_{OUT} = -30$ dBm.	1		5.5		mA	2
$I_{START,TX}$	TX startup current.	2		7		mA	1
$I_{RX,250}$	RX only run current at 250 kbps.			12.6		mA	1
$I_{RX,1M}$	RX only run current at 1 Mbps.			13		mA	4
$I_{RX,2M}$	RX only run current at 2 Mbps.			13.4		mA	1
$I_{START,RX}$	RX startup current.	3		8.7		mA	1

1. Valid for data rates 250 kbps, 1 Mbps, and 2 Mbps.
2. Average current consumption (at 0 dBm TX output power) for TX startup (130 μ s), and when changing mode from RX to TX (130 μ s).
3. Average current consumption for RX startup (130 μ s), and when changing mode from TX to RX (130 μ s).

5.4.2 Transmitter Specifications

Symbol	Description	Min.	Typ.	Max.	Units	Test level
P_{RF}	Maximum output power.		4		dBm	4
P_{RFC}	RF power control range.	20	24		dB	2
PRFCR	RF power accuracy.			± 4	dB	1
P_{WHISP}	RF power whisper mode.		-30		dBm	2
P_{BW2}	20 dB bandwidth for modulated carrier (2 Mbps).		1800	2000	kHz	2
P_{BW1}	20 dB bandwidth for modulated carrier (1 Mbps).		950	1100	kHz	2
P_{BW250}	20 dB bandwidth for modulated carrier (250 kbps).		700	800	kHz	2
$P_{RF1.2}$	1 st Adjacent Channel Transmit Power. ± 2 MHz (2 Mbps).			-20	dBc	2
$P_{RF2.2}$	2 nd Adjacent Channel Transmit Power. ± 4 MHz (2 Mbps).			-45	dBc	2
$P_{RF1.1}$	1 st Adjacent Channel Transmit Power. ± 1 MHz (1 Mbps).			-20	dBc	2
$P_{RF2.1}$	2 nd Adjacent Channel Transmit Power. ± 2 MHz (1 Mbps).			-40	dBc	2
$P_{RF1.250}$	1 st Adjacent Channel Transmit Power. ± 1 MHz (250 kbps).			-25	dBc	2
$P_{RF2.250}$	2 nd Adjacent Channel Transmit Power. ± 2 MHz (250 kbps).			-40	dBc	2
$t_{TX,30}$	Maximum consecutive transmission time, $f_{TOL} < \pm 30$ ppm.			16	ms	1
$t_{TX,60}$	Maximum consecutive transmission time, $f_{TOL} < \pm 60$ ppm.			4	ms	1

5.4.3 Receiver Specifications

Symbol	Description	Min.	Typ.	Max.	Units	Test level
Receiver operation						
PRX _{MAX}	Maximum received signal strength at < 0.1% PER.		0		dBm	1
PRX _{SENS,2M}	Sensitivity (0.1% BER) at 2 Mbps.		-85		dBm	2
PRX _{SENS,1M}	Sensitivity (0.1% BER) at 1 Mbps.		-90		dBm	2
PRX _{SENS,250k}	Sensitivity (0.1% BER) at 250 kbps.		-96		dBm	2
P _{SENS IT} 1 Mbps BLE	Receiver sensitivity: Ideal transmitter.		-93		dBm	2
P _{SENS DT} 1 Mbps BLE	Receiver sensitivity: Dirty transmitter. ¹		-91		dBm	2
RX selectivity - modulated interfering signal²						
2 Mbps						
C/I _{CO}	C/I co-channel.		12		dB	2
C/I _{1ST}	1 st ACS, C/I 2 MHz.		-4		dB	2
C/I _{2ND}	2 nd ACS, C/I 4 MHz.		-24		dB	2
C/I _{3RD}	3 rd ACS, C/I 6 MHz.		-28		dB	2
C/I _{6th}	6 th ACS, C/I 12 MHz.		-44		dB	2
C/I _{Nth}	N th ACS, C/I f _i > 25 MHz.		-50		dB	2
1 Mbps						
C/I _{CO}	C/I co-channel (1 Mbps).		12		dB	2
C/I _{1ST}	1 st ACS, C/I 1 MHz.		4		dB	2
C/I _{2ND}	2 nd ACS, C/I 2 MHz.		-24		dB	2
C/I _{3RD}	3 rd ACS, C/I 3 MHz.		-30		dB	2
C/I _{6th}	6 th ACS, C/I 6 MHz.		-40		dB	2
C/I _{12th}	12 th ACS, C/I 12 MHz.		-50		dB	2
C/I _{Nth}	N th ACS, C/I f _i > 25 MHz.		-53		dB	2

Symbol	Description	Min.	Typ.	Max.	Units	Test level
250 kbps						
C/I _{CO}	C/I co-channel.		4		dB	2
C/I _{1ST}	1 st ACS, C/I 1 MHz.		-10		dB	2
C/I _{2ND}	2 nd ACS, C/I 2 MHz.		-34		dB	2
C/I _{3RD}	3 rd ACS, C/I 3 MHz.		-39		dB	2
C/I _{6th}	6 th ACS, C/I $f_i > 6$ MHz.		-50		dB	2
C/I _{12th}	12 th ACS, C/I 12 MHz.		-55		dB	2
C/I _{Nth}	N th ACS, C/I $f_i > 25$ MHz.		-60		dB	2
Bluetooth Low Energy RX selectivity						
C/I _{CO}	C/I co-channel.		10		dB	2
C/I _{1ST}	1 st ACS, C/I 1 MHz.		1		dB	2
C/I _{2ND}	2 nd ACS, C/I 2 MHz.		-25		dB	2
C/I _{3+N}	ACS, C/I (3+n) MHz offset [n = 0, 1, 2, ...].		-51		dB	2
C/I _{Image}	Image blocking level.		-30		dB	2
C/I _{Image±1MHz}	Adjacent channel to image blocking level (± 1 MHz).		-31		dB	2
RX intermodulation³						
P_IMD _{2Mbps}	IMD performance, 2 Mbps, 3rd, 4th, and 5th offset channel.		-41		dBm	2
P_IMD _{1Mbps}	IMD performance, 1 Mbps, 3rd, 4th, and 5th offset channel.		-40		dBm	2
P_IMD _{250kbps}	IMD performance, 250 kbps, 3rd, 4th, and 5th offset channel.		-36		dBm	2
P_IMD _{BLE}	IMD performance, 1 Mbps BLE, 3rd, 4th, and 5th offset channel.		-39		dBm	2

1. As defined in the *Bluetooth Core Specification v4.0 Volume 6: Core System Package (Low Energy Controller Volume)*.
2. Wanted signal level at $P_{IN} = -67$ dBm. One interferer is used, having equal modulation as the wanted signal. The input power of the interferer where the sensitivity equals BER = 0.1% is presented.
3. Wanted signal level at $P_{IN} = -64$ dBm. Two interferers with equal input power are used. The interferer closest in frequency is not modulated, the other interferer is modulated equal with the wanted signal. The input power of interferers where the sensitivity equals BER = 0.1% is presented.

5.4.4 Radio Timing Parameters

Symbol	Description	250 k	1 M	2 M	BLE	Jitter	Units
t_{TXEN}	Time between TXEN task and READY event.	132	132	132	140	0	μs
$t_{TXDISABLE}$	Time between DISABLE task and DISABLED event when the radio was in TX.	10	4	3	4	1	μs
t_{RXEN}	Time between the RXEN task and READY event.	130	130	130	138	0	μs
$t_{RXDISABLE}$	Time between DISABLE task and DISABLED event when the radio was in RX.	0	0	0	0	1	μs
$t_{TXCHAIN}$	TX chain delay.	5	1	0.5	1	0	μs
$t_{RXCHAIN}$	RX chain delay.	12.5	3	2	3	0	μs

5.4.5 RSSI Specifications

Symbol	Description	Note	Min.	Typ.	Max.	Units	Test level
$RSSI_{ACC}$	RSSI accuracy.	Valid range -50 dBm to -80 dBm.			± 6	dB	2
$RSSI_{RESOLUTION}$	RSSI resolution.			1		dB	1
$RSSI_{PERIOD}$	Sample period.		8.8			μs	1
$RSSI_{CURRENT}$	Current consumption in addition to I_{RX} .			250		μA	1

5.4.6 CPU

Symbol	Description	Min.	Typ.	Max.	Units	Test level
$I_{CPU, FLASH}$	Run current at 16 MHz (XOSC). Executing code from flash memory.		4.1 ¹		mA	2
$I_{CPU, RAM}$	Run current at 16 MHz (XOSC). Executing code from RAM.		2.4 ²		mA	1
$I_{START, CPU}$	CPU startup current.		600		μA	1
$t_{START, CPU}$	IDLE to CPU execute.	0 ³			μs	1

1. Includes CPU, flash, 1V2, 1V7, RC16M.
2. Includes CPU, RAM, 1V2, RC16M.
3. t_{1V2} if 1V2 regulator is not running already.

5.4.7 Power Management

Symbol	Description	Note	Min.	Typ.	Max.	Units	Test level
I_{OFF}	Current in SYSTEM OFF, no RAM retention.			0.6 ¹		μA	2
$I_{OFF, RET, 8k}$	Additional current in SYSTEM OFF per retained RAM block (8 kB).			0.6 ¹		μA	2
I_{OFF2ON}	OFF to CPU execute transition current.			400		μA	1
t_{OFF2ON}	OFF to CPU execute.			9.6	10.6	μs	1
$I_{ON,16k}$	SYSTEM-ON base current with 16 kB RAM enabled.			2.6 ¹		μA	2
$I_{ON,32k}$	SYSTEM-ON base current with 32 kB RAM enabled.			3.8 ¹		μA	2
t_{1V2}	Startup time for 1V2 regulator.			2.3		μs	1
$I_{1V2XO16}$	Current drawn by 1V2 regulator and 16 MHz XOSC when both are on at the same time.			810 ²		μA	1
$I_{1V2XO32}$	Current drawn by 1V2 regulator and 32 MHz XOSC when both are on at the same time.			840 ²		μA	1
$I_{1V2RC16}$	Current drawn by 1V2 regulator and 16 MHz RCOSC when both are on at the same time.			880 ²		μA	1
$I_{1V2XO16,1M}$	For HFCLK in 1 MHz mode ³ . Current drawn by 1V2 regulator and 16 MHz XOSC when both are on at the same time.	See Table 33 on page 49.		520 ²		μA	1
$I_{1V2XO32,1M}$	For HFCLK in 1 MHz mode ³ . Current drawn by 1V2 regulator and 32 MHz XOSC when both are on at the same time.	See Table 33 on page 49.		560 ²		μA	1
$I_{1V2RC16,1M}$	For HFCLK in 1 MHz mode ³ . Current drawn by 1V2 regulator and 16 MHz RCOSC when both are on at the same time.	See Table 33 on page 49.		630 ²		μA	1
t_{XO}	Startup time for the clock management system when the XTAL is in standby.			2.3	5.3	μs	1
t_{1V7}	Startup time for 1V7 regulator.			2	3.6	μs	1
I_{1V7}	Current drawn by 1V7 regulator.			105		μA	2
F_{DCDC}	DC/DC converter current conversion factor.		0.65 ⁴		1.2 ⁴		1

1. Add 1 uA to the current value if the device is used in Low voltage mode.

2. This number includes the current used by the automated power and clock management system.

3. For details on 1 MHz mode, see Nordic's nRF51822 spec sheet.

4. F_{DCDC} will vary depending on VDD and internal radio current consumption (IDD). Please refer to the nRF51 series reference manual v.3.0 or later, for a method to calculate IDD_{DCDC} .

6. Block Diagram

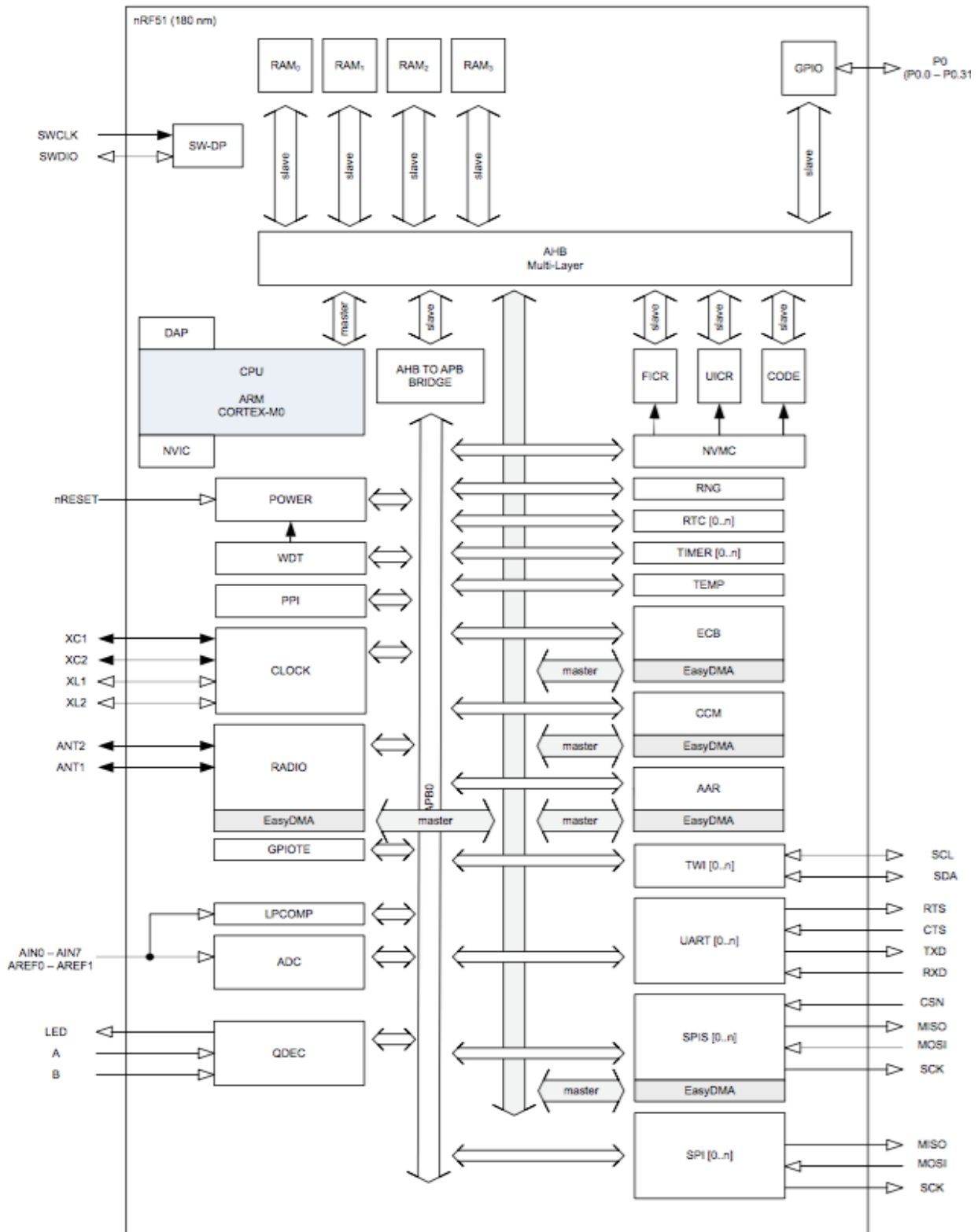

nRF51822 block diagram

7. Antenna

7.1 MDBT40 Series



AT7020 Series Multilayer Chip Antenna

Features

- ❖ Monolithic SMD with small, low-profile and light-weight type.
- ❖ Wide bandwidth

Applications

- ❖ 2.4GHz WLAN, Home RF, Bluetooth Modules, etc.



Specifications

Part Number	Frequency Range (MHz)	Peak Gain (dBi typ.)	Average Gain (dBi typ.)	VSWR	Impedance
AT7020 -E3R0HBA_	2400~2500	1.3dBi (XZ-V)	-0.5dBi (XZ-V)	2 max.	50 Ω

- ❖ Return Loss/With Matching Circuits

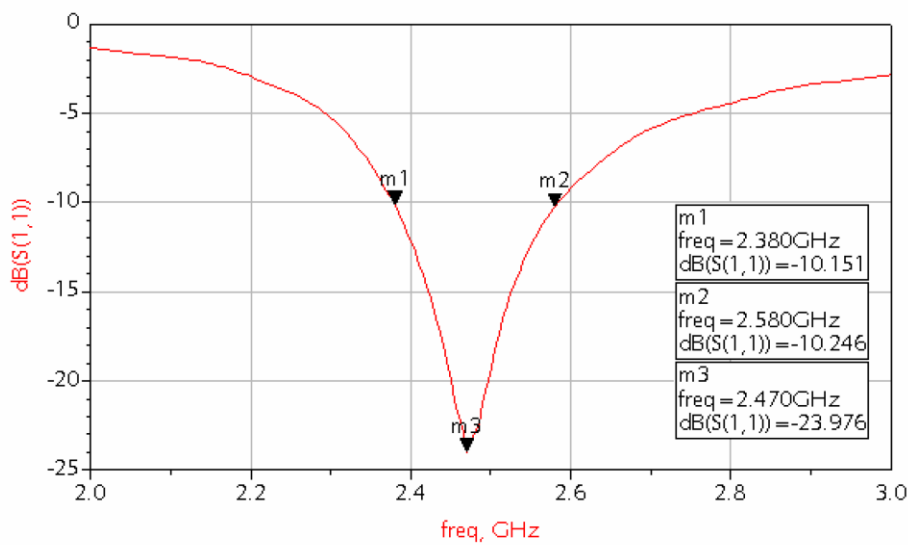

❖ Radiation Patterns

XY-V/XY-H

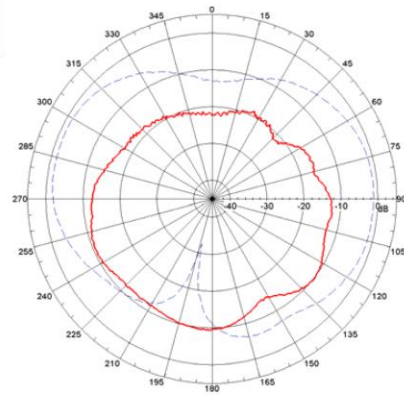
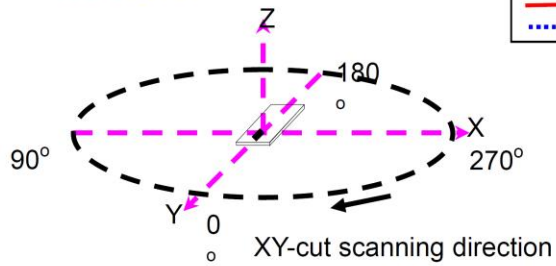

XZ-V/XZ-H

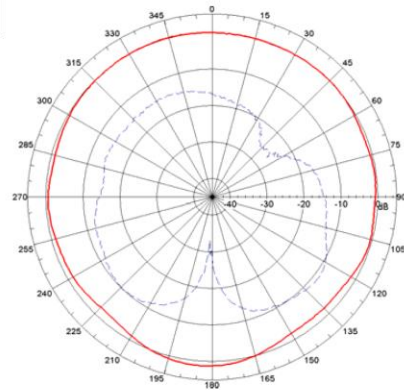
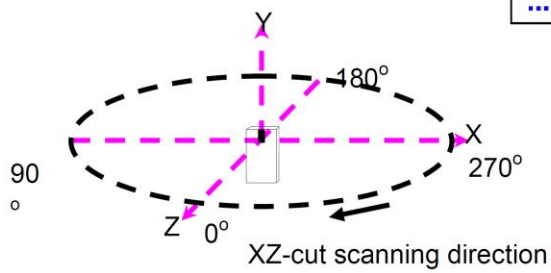

YZ-V/YZ-H

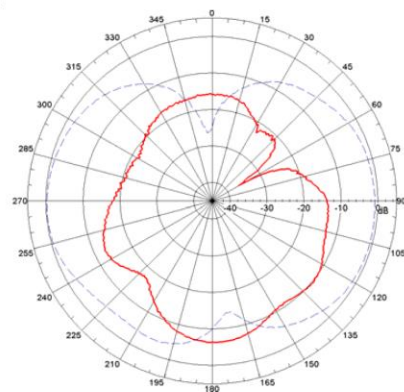
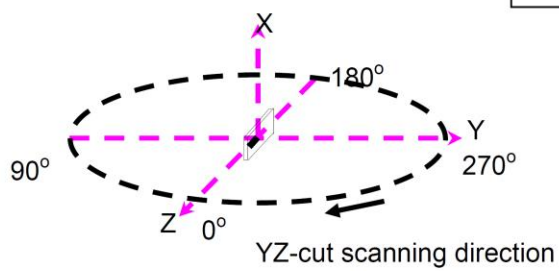

7.2 MDBT40-P Series

Antenna Manufacturer : Raytac Corporation.

MODEL:Printed Trace Antenna

C. X-Z polarization scan

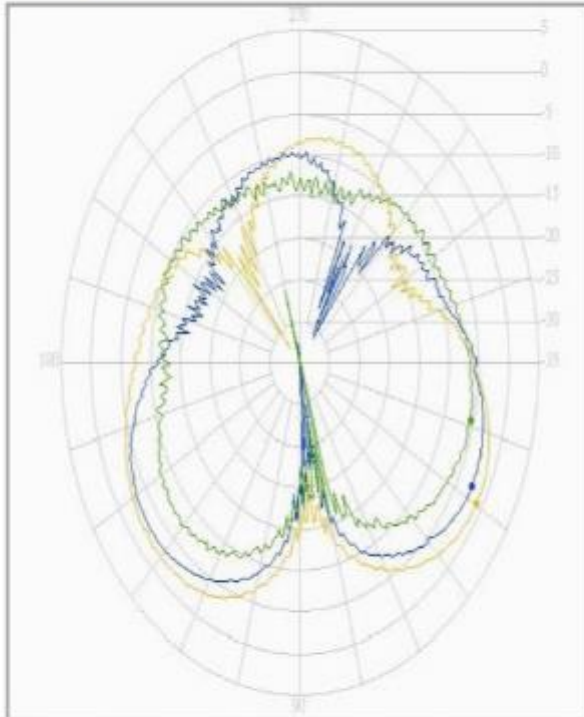

Model No.	Ant Polarization	Freq(MHz)	Peak angle	Value	Average
XZ 2400 H	Horizontal	2400.0	330.3	-0.9	-6.1
XZ 2450 H	Horizontal	2450.0	332.8	-2.5	-7.6
XZ 2500 H	Horizontal	2500.0	346.0	-5.5	-9.8

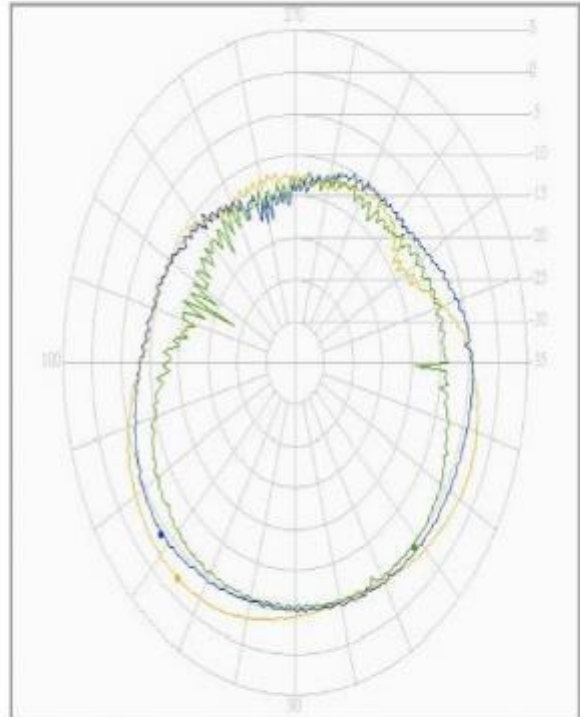

Model No.	Ant Polarization	Freq(MHz)	Peak angle	Value	Average
XZ 2400 V	Vertical	2400.0	232.1	-2.0	-5.7
XZ 2450 V	Vertical	2450.0	221.8	-4.1	-6.6
XZ 2500 V	Vertical	2500.0	312.7	-4.8	-8.5



8. Reference Circuit

8.1 nRF51822 Schematic with Internal LDO (Module's Default)

Module is pre-programmed with Raytac's testing code. Default is using external 32.768khz crystal. Please make sure it is connected to make module work.

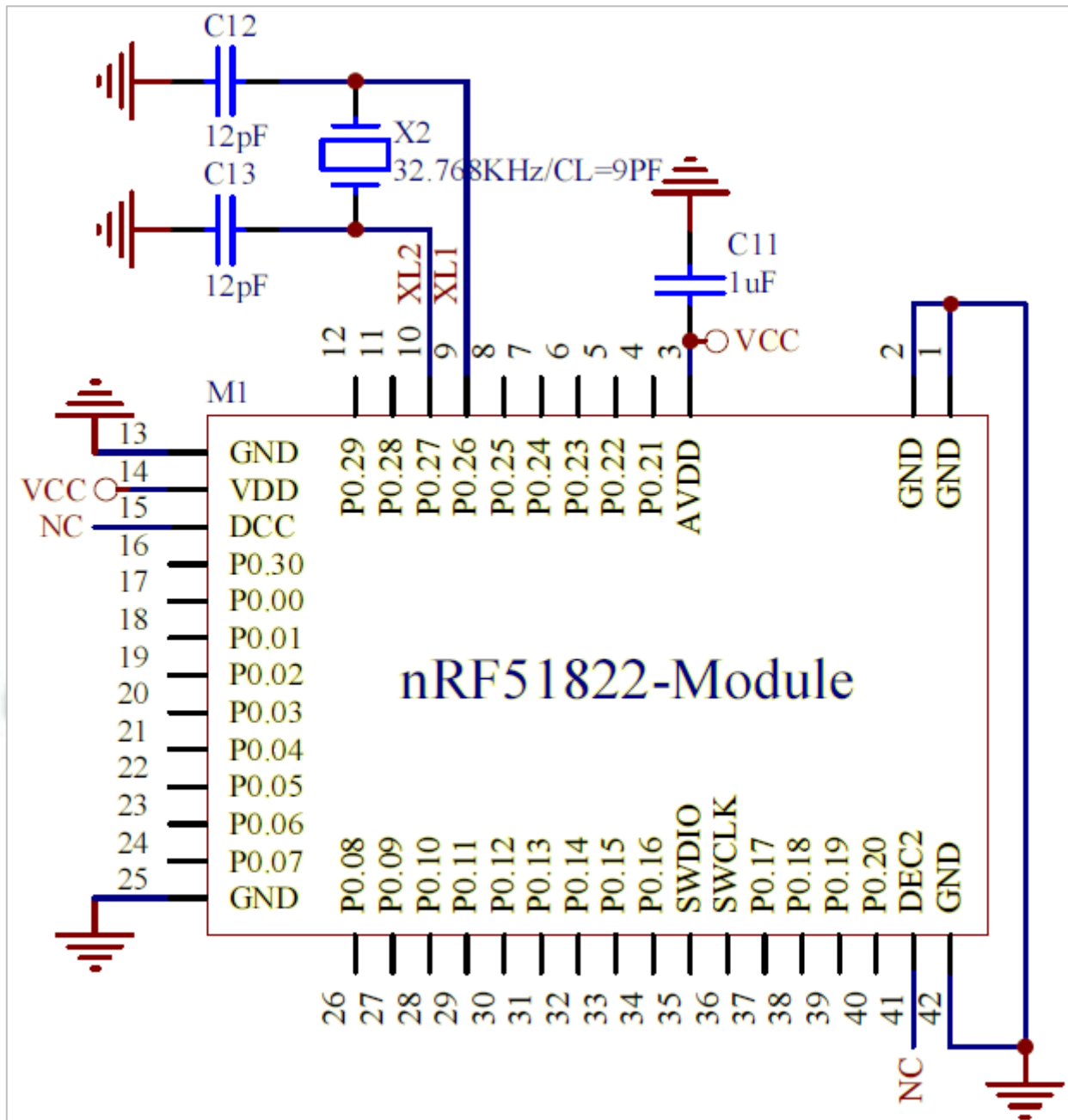

8.2 nRF51822 Schematic with 1.8V Low Voltage Mode

1. When operating temperature is from -40°C to 105°C , it is not supported 1.8V low voltage mode.
2. External 32.768khz is optional.

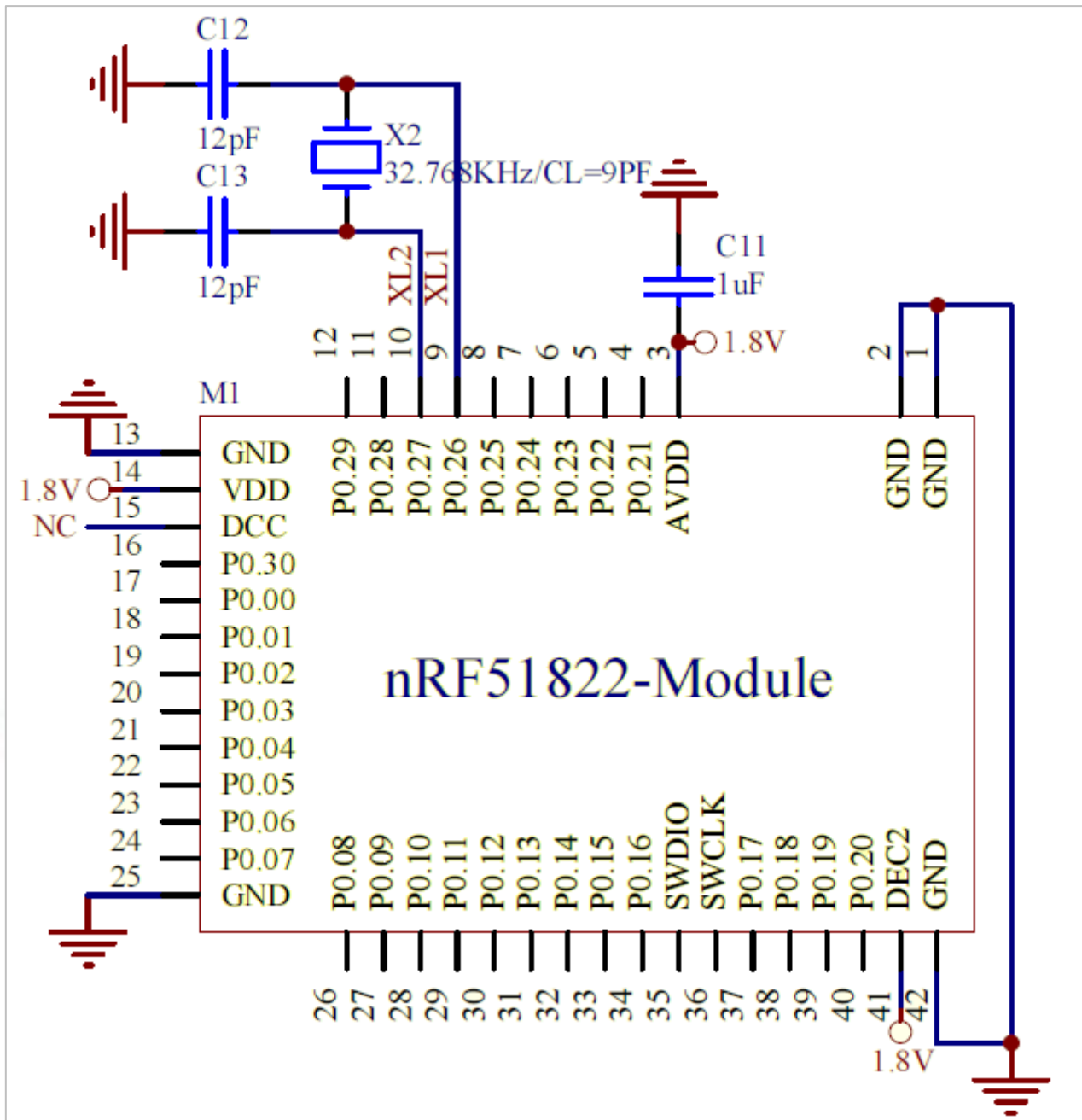

8.3 nRF51822 Schematic with Internal DC/DC Converter

External 32.768kHz is optional.

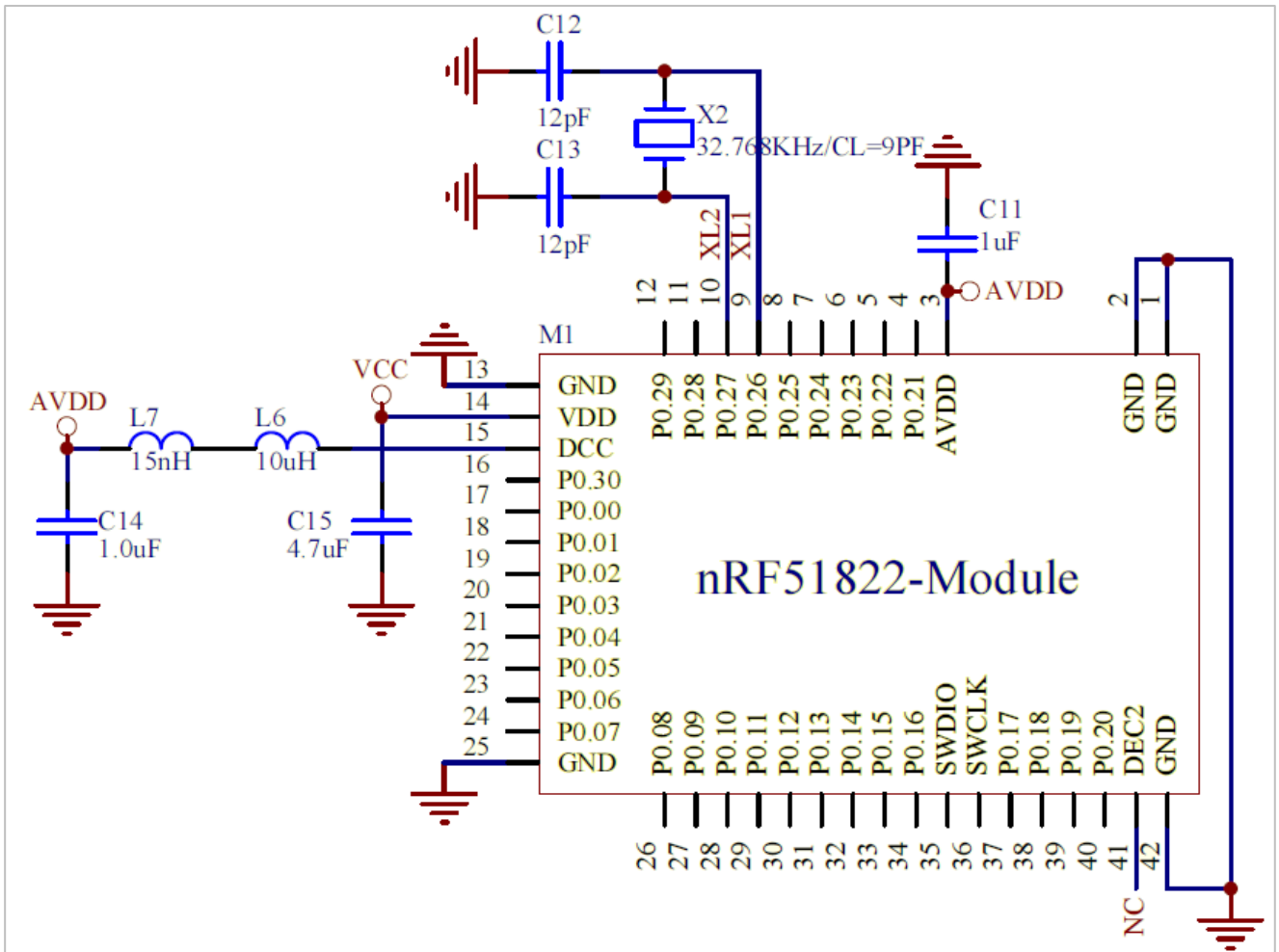

9. Certification

9.1 Declaration ID

Declaration ID	QDID(s)	Company	Specification Name
D042310	91659 - Profile Subsystem 80592 - End Product 111537 - Profile Subsystem	Raytac Corporation	4.2

SIG (the Bluetooth organization) will deprecate BT 4.0 / 4.1 in 2019/01/28 and withdraw any product listing 2020/07/01. If you would like to know more details, please check out [this post](#) . You are more than welcomed to send your questions to service@raytac.com or your contact at Raytac. We are happy to help.

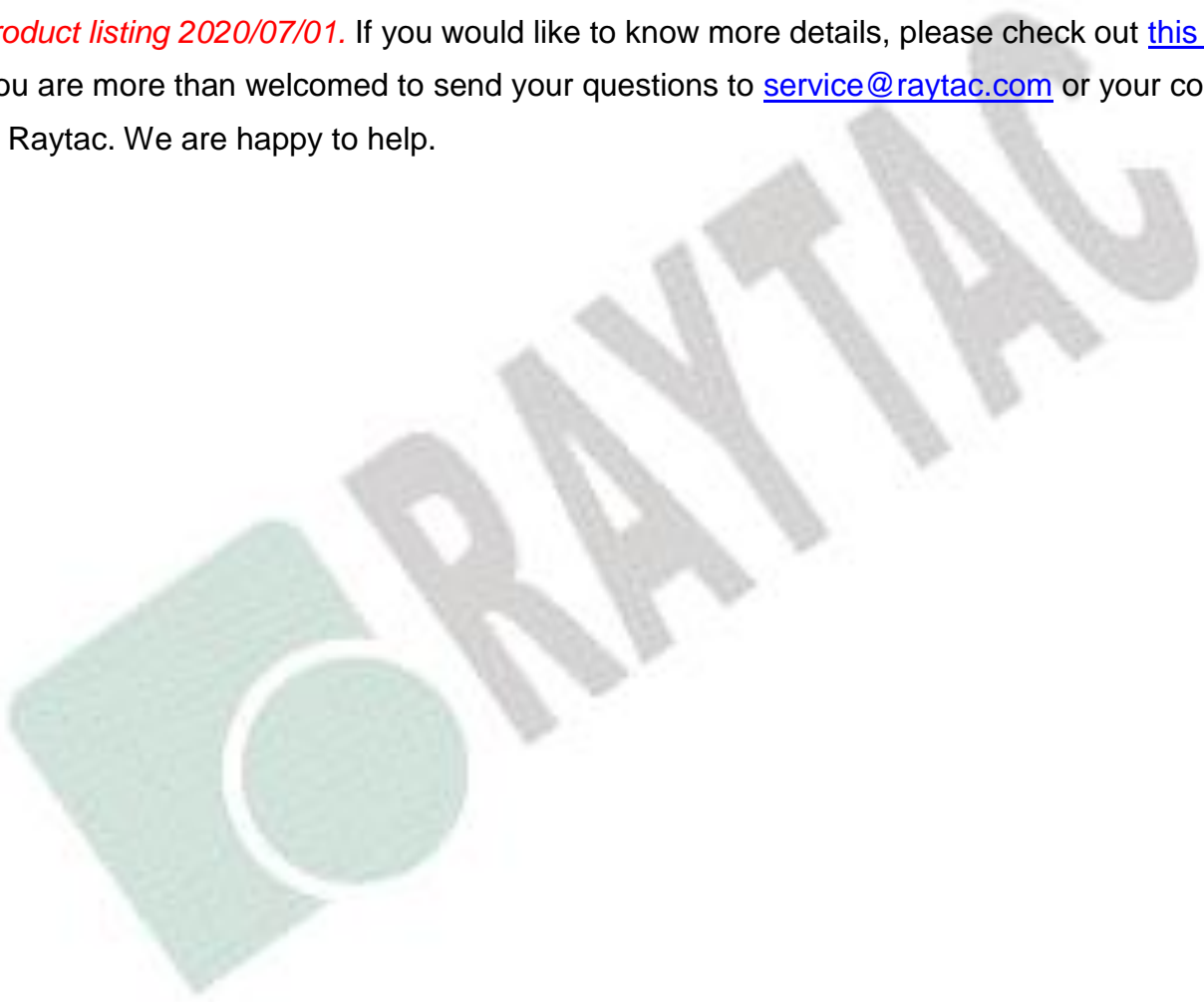

9.2 FCC Certificate (USA)

TCB	GRANT OF EQUIPMENT AUTHORIZATION Certification Issued Under the Authority of the Federal Communications Commission By:	TCB												
	PHOENIX TESTLAB GmbH Koenigswinkel 10 32825 Blomberg, Germany	Date of Grant: 03/24/2015 Application Dated: 03/24/2015												
Raytac Corp. 5F., No.3, Jiankang Rd., Zhonghe Dist., New Taipei City,, 23586 Taiwan Attention: Venson Liao , R&D Manager														
NOT TRANSFERABLE														
EQUIPMENT AUTHORIZATION is hereby issued to the named GRANTEE, and is VALID ONLY for the equipment identified hereon for use under the Commission's Rules and Regulations listed below.														
FCC IDENTIFIER: SH6MDBT40														
Name of Grantee: Raytac Corp.														
Equipment Class: Digital Transmission System														
Notes: BT 4.0 Module														
Modular Type: Single Modular														
<u>Grant Notes</u>	<u>FCC Rule Parts</u>	<table border="0" style="width: 100%; border-collapse: collapse;"> <thead> <tr> <th style="text-align: center;"><u>Frequency Range (MHZ)</u></th> <th style="text-align: center;"><u>Output Watts</u></th> <th style="text-align: center;"><u>Frequency Tolerance</u></th> <th style="text-align: center;"><u>Emission Designator</u></th> </tr> </thead> <tbody> <tr> <td style="text-align: center;">15C</td> <td style="text-align: center;">2402.0 - 2480.0</td> <td style="text-align: center;">0.0027</td> <td></td> </tr> <tr> <td style="text-align: center;">15C</td> <td style="text-align: center;">2405.0 - 2480.0</td> <td style="text-align: center;">0.0028</td> <td></td> </tr> </tbody> </table>	<u>Frequency Range (MHZ)</u>	<u>Output Watts</u>	<u>Frequency Tolerance</u>	<u>Emission Designator</u>	15C	2402.0 - 2480.0	0.0027		15C	2405.0 - 2480.0	0.0028	
<u>Frequency Range (MHZ)</u>	<u>Output Watts</u>	<u>Frequency Tolerance</u>	<u>Emission Designator</u>											
15C	2402.0 - 2480.0	0.0027												
15C	2405.0 - 2480.0	0.0028												
Output power listed is peak conducted, This OEM module is approved for use in products operating as portable transmitting device. End users may not be provided with the module installation instructions.														
This Class II Permissive Change covers the performed modifications as documented in the filing.														



Certificate Number: INF412101

This is to certify that the following products have been tested by us with the listed standards and found in conformity with the procedures given in ANSI C63.4-2009 and all tests are performed according to FCC Part 15 and Canada Standard ICES-003 Issue 5 Rules.

This Certificate applies to the tested sample below mentioned only and shall not imply an assessment of the whole production. It is only valid in connection with the test report number: FD412101.

Applicant : Raytac Corporation
 Product Name : BT4.0 module
 Model No. : MDBT40
 Brand Name : Raytac

Applied Standards : FCC Part 15, Subpart B, Class B
 ICES-003 Issue 5
 ANSI C63.4:2009



Kent Chen
 Kent Chen / Assistant Manager
 February 12, 2014

International Certification Corp.

Address: No. 3-1, Lane 6, Wen San 3rd St., Kwei Shan Hsiang, Tao Yuan Hsien 333, Taiwan, R.O.C.
 Tel: 886-3-271-8666, Fax: 886-3-318-0155

Rev. 01

9.3 TELEC Certificate (Japan)

Annex 1 to
Certificate No 14-110771
of Technical Regulations Conformity
for Specified Radio Equipment in Japan



- The validity of this certificate is limited to products, which are equal to the one examined in the type-examination.
- When the holder of this certificate is placing the product on the Japanese market, the product must be affixed with the following Specified Radio Equipment marking:



Remarks and observations:

The following conditions are applicable:

- Chip Antenna, MDBT40, with a maximum gain of 1.3 dBi for the 2.4 GHz band

Documentation lodged for the type examination:

Testreports:

- International Certification Corp.: JR412101AC, Feb.12, 2014
- International Certification Corp.: JR412101AE, Feb.12, 2014

Product documentation:

- Block Diagram
- Bill of Materials
- Photos
- User Manual
- Circuit Diagram
- Placement Drawings
- Antenna Specifications

Technical standards and specifications

The product complies with:

- Ordinance Regulating Radio Equipment
- Chapter I, General Provisions
- Chapter II, Transmitting Equipment
- Chapter III, Receiving Equipment
- Chapter IV, Article 49.20

9.4 NCC Certificate (Taiwan)

MDBT40 Series

耕興股份有限公司

低功率射頻電機型式認證證明

- (1) 申請者 : 勁達國際電子有限公司
(臺北市大安區和平東路 1 段 145 號 5 樓之 1)
- (2) 製造廠商 : Ginstar Corporation
- (3) 器材名稱 : BT4.0 module
- (4) 廠牌 / 型號 : Raytac / MDBT40
- (5) 發射功率 (電場強度) : 2.402-2.480 GHz: 4.38dBm
- (6) 工作頻率 : 2.402-2.480 GHz (GFSK 40CH, ChS-2MHz)
- (7) 審驗日期 : 104 年 02 月 04 日
- (8) 審驗合格標籤式樣 :

 CCAF15LP0280T1



說明：

- 請依上列標籤式樣自製標籤，標貼或印鑄於器材本體明顯處，始得販賣或公開陳列。
- 經型式認證合格之低功率射頻電機，其廠牌、型號、設計、射頻性能如有變更，應重新申請型式認證。
- 違反低功率電波輻射性電機管理辦法之規定，擅自使用或變更無線電頻率、電功率者，除依電信法規定處罰外，驗證機關(構)並得廢止其型式認證證明或型式認證標籤。
- 送審廠商應保留送審樣品供日後核對。
- 本型式認證證明及其合格標籤使用權專屬取得本證明者。依電信管制射頻器材審驗辦法第 15 條規定，持有人得經由網際網路申請同意他人於同廠牌同型號之電信管制射頻器材使用型式認證標籤，並於次日起 30 天內，應檢具「電信管制射頻器材審驗合格標籤或符合性聲明標籤同意使用備查表」送國家通訊傳播委員會備查。

備註：

- 本器材符合低功率射頻電機技術規範(第 3.10.1 章節)之規定。
- 本器材使用 Chip 天線，天線增益 1.3dBi。
- 本公司係經國家通訊傳播委員會委託之驗證機構(電信管制射頻器材驗證機構認證證書號碼：NCC-RCB-05/電信終端設備驗證機構認證證書號碼：NCC-RCB-05)，核發本型式認證證明。
- 依「商品標示法」及「資訊、通信及消費性電子商品標示基準」規定，標示事項貼於商品或內外包裝上，以免違法而受處分。
- 本案審驗模組為完全模組，適用於任何平台。「平台」定義如下：若器材不組裝本案審驗模組，消費者仍能正常使用該器材主要功能，該器材得視為平台。若器材不組裝本案審驗模組，消費者不能正常使用該器材主要功能，則該器材不能視為平台，該類不同廠牌型號器材組裝本案審驗模組後，須分別申請型式認證。

MDBT40-P Series

SGS

台灣檢驗科技股份有限公司

低功率射頻電機型式認證證明

- 一、申請者：勁達國際電子有限公司
地址：106 臺北市大安區和平東路1段145號5樓之1
- 二、製造廠商：Ginstar Corporation (中國廣東省中山市坦州鎮前進三路)
- 三、器材名稱：BT BLE Module
- 四、廠牌：Raytac
- 五、型號：MDBT40
- 六、發射功率：BT V4.0 Single Mode: 4.18dBm (Peak)
- 七、工作頻率：2402MHz - 2480MHz
- 八、審驗日期：104年04月02日
- 九、審驗合格標籤式樣：

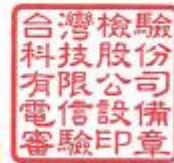

說明：

- 請依上列標籤式樣自製標籤，標貼或印鑄於器材本體明顯處，始得販賣或公開陳列。
- 經型式認證合格之低功率射頻電機，其廠牌、型號、設計、射頻性能如有變更，應重新申請型式認證。
- 違反低功率電波輻射性電機管理辦法之規定，擅自使用或變更無線電頻率、電功率者，除依電信法規定處罰外，驗證機關(構)並得廢止其型式認證證明或型式認證標籤。
- 送審廠商應保留送審樣品供日後核對。
- 本型式認證證明及其合格標籤使用權專屬取得本證明者。依電信管制射頻器材審驗辦法第15條規定，持有人得經由網際網路申請同意他人於同廠牌同型號之電信管制射頻器材使用型式認證標籤，並於次日起30天內，應檢具「電信管制射頻器材審驗合格標籤，或符合性聲明標籤同意使用備查表」送國家通訊傳播委員會備查。

備註：

- 本器材符合低功率射頻電機技術規範(3.10.1)之規定。
- 本公司僅對無線射頻特性技術規範辦理型式認證，其他仍須依本國相關法規辦理。
- 本器材使用天線型態：Printed Trace Antenna，廠牌：Raytac Corporation，型號：Printed Trace Antenna，增益：-0.8dBi。
- 本案審驗模組為完全模組，適用於任何平台。【平台】定義如下：若器材不組裝本案審驗模組，消費者仍能正常使用該器材主要功能，該器材得視為平台。若器材不組裝本案審驗模組，消費者不能正常使用該器材主要功能，該器材不能視為平台，該類不同廠牌型號器材組裝本案審驗模組後，須分別申請型式認證。
- 本公司係經國家通訊傳播委員會委託之驗證機構，核發本型式認證證明。

9.5 CE Test Report (EU)



SGS Reference No: E1/2017/40113C

VERIFICATION OF EMC COMPLIANCE

Verification No. : E1/2017/40113C
Representative Model No. : MDBT40
Added Model(s) : MDBT40-P
Product Name : BT 4.1 Module
Brand Name : Raytac
Applicant : Raytac Corporation
Address of Applicant : 5F., No.3, Jiankang Road, Zhonghe District 23586, Taiwan
Test Report Number : E1/2017/40113
Date of Issue : May 19, 2017
Applicable Standards : EN 301 489-1_{v2.1.1} : 2017-02, EN 301 489-17_{v3.1.1} : 2017-02
EN 55032 : 2015+AC:2016-07
EN 61000-4-2 : 2009, EN 61000-4-3 : 2006+A1:2008+A2:2010

Conclusion

The apparatus meets the requirements of the above standards and hence compliance the essential requirements under article 3.1b of the RED (2014/53/EU) Directive.

*This verification is only valid for the equipment and configuration described, and in conjunction with the test report as detailed above.



Authorized Signatory:

Wisely Huang

SGS TAIWAN LTD.
Wisely Huang
Technical Asst. Manager

VERIFICATION OF COMPLIANCE

Applicant: Raytac, Corp.
 5F., No.3, Jiankang Road, Zhonghe District 23586, Taiwan.
Product Name: BT 4.1 Module
Brand Name: Raytac
Model No.: MDBT40, MDBT40-P
Model Difference: MDBT40 with chip antenna; MDBT40-P with PCB antenna
File Number: ER/2016/80199-02
Date of test: Aug. 26, 2016~May 04, 2017
Date of EUT Received: Aug. 26, 2016

APPLICABLE STANDARDS	
STANDARD	TEST RESULT
ETSI EN 300 328 v2.1.1: 2016	Complied

The above equipment was tested by SGS Taiwan Ltd., Electronics & Communication Laboratory for compliance with the requirements set forth in the European Standard ETSI EN 300 328 v2.1.1: 2016 under RED 2014/53/EU. The results of testing in this report apply to the product system that was tested only. Other similar equipment will not necessarily produce the same results due to production tolerance and measurement uncertainties.

Test By:

Jay Lin

Date:

May 10, 2017

Jay Lin / Engineer

Prepared By:

Tiffany Kao

Date:

May 10, 2017

Tiffany Kao / Clerk

Approved
By:

Jim Chang

Date:

May 10, 2017

Jim Chang / Asst. Manager

9.6 IC Certificate (Canada)

<p>telefication bv The Netherlands Chamber of Commerce 51565536 www.telefication.com</p> <p>CB Industry Canada Industrie Canada</p> <p>▶ Reg. No. NL0001</p>		<p>telefication</p>
<p>TECHNICAL ACCEPTANCE CERTIFICATE CERTIFICAT D'ACCEPTABILITÉ TECHNIQUE</p>		
<p>CERTIFICATION No. No. DE CERTIFICATION</p> <p>TELEFICATION No. No. DE TELEFICATION</p> <p>TEST SITE No. No. DE LABORATOIRE</p> <p>ISSUED TO DÉLIVRÉ À</p> <p>TYPE OF EQUIPMENT GENRE DE MATÉRIEL</p> <p>TRADE NAME AND MODEL MARQUE ET MODÈLE</p> <p>CERTIFIED TO CERTIFIÉ SELON LE</p>	<p>▶ 8017A-MDBT40</p> <p>▶ 152170125/AA/00</p> <p>▶ 4620A-5</p> <p>▶ Raytac Corporation</p> <p>▶ Bluetooth Device Modular Approval</p> <p>▶ Raytac MUB14U</p> <p>▶ SPECIFICATION CAHIER DES CHARGES</p>	<p>RSS-247</p> <p>ISSUE EDITION</p> <p>Issue 1</p>
<p>Certification of equipment means only that the equipment has met the requirements of the above-noted specification. Licence applications, where applicable to use certified equipment, are acted on accordingly by the Industry Canada Issuing office and will depend on the existing radio environment, service and location of operation. This certificate is issued on condition that the holder complies and will continue to comply with the requirements and procedures issued by Industry Canada. The equipment for which this certificate is issued shall not be manufactured, imported, distributed, leased, offered for sale or sold unless the equipment complies with the applicable technical specifications and procedures issued by Industry Canada.</p> <p>La certification du matériel signifie seulement que le matériel a satisfait aux exigences de la norme indiquée ci-dessus. Les demandes de licences nécessaires pour l'utilisation du matériel certifié sont traitées en conséquence par le bureau de délivrance d'Industrie Canada et dépendent des conditions radio ambiantes, du service et de l'emplacement d'exploitation. Le présent certificat est délivré à la condition que le titulaire satisfasse et continue de satisfaire aux exigences et aux procédures d'Industrie Canada. Le matériel à l'égard duquel le présent certificat est délivré ne doit pas être fabriqué, importé, distribué, loué, mis en vente ou vendu à moins d'être conforme aux procédures et aux spécifications techniques applicables publiées par Industrie Canada.</p>		
<p>ISSUED BY TELEFICATION BV, RECOGNIZED CERTIFICATION BODY BY INDUSTRY CANADA DÉLIVRÉ PAR TELEFICATION BV, ORGANISME DE CERTIFICATION RECONNU PAR INDUSTRIE CANADA</p>		
<p><i>I hereby attest that the subject equipment was tested and found in compliance with the above-noted specification. J'atteste, par la présente, que le matériel a fait l'objet d'essai et a été jugé conforme à la spécification ci-dessus.</i></p>		
<p>DATE 15 June 2015 BY</p> <p>This certificate has one annex.</p>	<p>W.J.M. Jong Manager Product Certification</p> <p>i.o. </p>	 <p>PRODUCTS RvA C 224</p>

9.7 SRRC Certificate (China)

无线电发射设备
Radio Transmission Equipment
型号核准证
Type Approval Certificate

劲达国际电子有限公司（台湾）：

根据《中华人民共和国无线电管理条例》
In accordance with the provisions on the Radio
Regulations of the People's Republic of China, the following
符合中华人民共和国无线电管理规定和
radio transmission equipment, after examination, conforms
技术标准，其核准代码为：CMIIT ID: 2015DJ2435
to the provisions with its CMIIT ID:

Sealed by issuing authority

有效期：五年
Validity

2015 年 6 月 2 日
Year Month Date

9.8 KC Certificate (South Korea)

0D0F-48CC-97AD-AA45

방송통신기자재등의 적합인증서 <i>Certificate of Broadcasting and Communication Equipments</i>	
상호 또는 성명 <i>Title Name or Applicant</i>	Raytac Corporation
기자재 명칭 <i>Equipment Name</i>	특정소출력 무선기기(무선데이터통신시스템용 무선기기)
기본모델명 <i>Basic Model Number</i>	MDBT40
파생모델명 <i>Series Model Number</i>	MDBT40-P
인증번호 <i>Certification No.</i>	MSIP-CRM-ryt-MDBT40
제조사/제조국가 <i>Manufacturer/ Country of Origin</i>	Raytac Corporation / 대만
인증연월일 <i>Date of Certification</i>	2016-11-29
기타 <i>Others</i>	
<p>위 기자재는 「전파법」 제58조의2 제2항에 따라 인증되었음을 증명합니다.</p> <p>It is verified that foregoing equipment has been certificated under the Clause 2, Article 58-2 of Radio Waves Act.</p> <p style="text-align: right;">2016년(Year) 11월(Month) 29일(Date)</p> <p style="text-align: center;">국립전파연구원장 </p> <p style="text-align: center;"><i>Director General of National Radio Research Agency</i></p> <p>※ 인증 받은 방송통신기자재는 반드시 "적합성평가표시" 를 부착하여 유통하여야 합니다. 위반시 과태료 처분 및 인증이 취소될 수 있습니다.</p>	

9.9 RCM Test Report (Australia & New Zealand)



Report No.: ER/2015/C0093
Page: 2 of 33

VERIFICATION OF COMPLIANCE

Applicant: Raytac Corporation
5F, No.3, Jiankang Rd., Zhonghe Dist., New Taipei City, 23586,
Taiwan

Product Name: BT 4.0 Module

Brand Name: Raytac

Model No.: MDBT40-P, MDBT40

Model Difference: MDBT40-P use Printed Trace Antenna
MDBT40 use Chip Antenna

Report Number: BT 4.0 Module

Date of test: Dec. 31, 2015 ~ Jan. 11, 2016

Date of EUT Received: Dec. 31, 2015

APPLICABLE STANDARDS

STANDARD	TEST RESULT
AS/NZS 4268:2012 Row 45A	Complied

The above equipment was tested by SGS Taiwan Ltd., Electronics & Communication Laboratory for compliance with the requirements set forth in the Australian/New Zealand Standard AS/NZS 4268:2012, Row 45A. The results of testing in this report apply to the product system that was tested only. Other similar equipment will not necessarily produce the same results due to production tolerance and measurement uncertainties.

Test By:

Marcus Tseng

Date:

Jan. 15, 2016

Marcus Tseng / Sr. Engineer

Prepared By:

Allen Tsai

Date:

Jan. 15, 2016

Allen Tsai / Engineer

Approved By:

Jim Chang

Date:

Jan. 15, 2016

Jim Chang / Asst. Manager

9.10 ANATEL Certificate (Brazil)

República Federativa do Brasil
Agência Nacional de Telecomunicações

Certificado de Homologação
(Intransferível)

Nº 00672-16-02503
 Validado: Indeterminada
 Emissão: 29/11/2017

Requerente: DAMKTECH LTDA. - ME **Fabricante: RAYTAC CORPORATION**
ROBERTO SIMONSEN Nº315 JARDIM BELA VISTA **5F, NO.3, JIANKANG RD., ZHONGHE DISTRICT NEW TAIPEI CITY**
13076416 CAMPINAS SP **TAIWAN**

Este documento homologa, nos termos da regulamentação de telecomunicações vigente, o Certificado de Conformidade nº MT-3645/2016, emitido pelo MASTER Associação de Avaliação de Conformidade. Esta homologação é expedida em nome do solicitante aqui identificado e é válida somente para o produto a seguir discriminado, cuja utilização deve observar as condições estabelecidas na regulamentação de telecomunicações.

Tipo - Categoria: Transceptor de Radiação Restrita - II
Modelo - Nome Comercial (s): MDBT40

Características técnicas básicas:

Faixa de Frequências Tx (MHz)	Potência Máxima de Saída (W)	Designação de Emissões	Tecnologias	Tipo de Modulação
2.400,0 a 2.483,5	0,003	1M64X9D	SEQUÊNCIA DIRETA	GFSK

Ensaio de SAR não aplicável.
Observações:
Produto não acabado, de uso interno, cuja integração em outros equipamentos pode requerer nova avaliação.
Este produto destina-se ao uso profissional, manuseado por pessoal devidamente qualificado, não sendo destinado ao uso do público em geral para acesso a serviço de telecomunicações de interesse coletivo.
Na instalação do produto devem ser observadas as condições de uso conforme estabelecido no Regulamento sobre Equipamentos de Radiocomunicação de Radiação Restrita.
O módulo modelo MDBT40 pode ser comercializado em duas versões de antena: Chip antena e Printed antena.
Este certificado substitui o de mesmo número emitido em 29/11/2017.

Constitui obrigação do fabricante do produto no Brasil providenciar a identificação do produto homologado, nos termos da regulamentação de telecomunicações, em todas as unidades comercializadas, antes de sua efetiva distribuição ao mercado, assim como observar e manter as características técnicas que fundamentaram a certificação original.

As informações constantes deste certificado de homologação podem ser confirmadas no SCH - Sistema de Gestão de Certificação e Homologação, disponível no portal da Anatel. (www.anatel.gov.br).

Marcos de Souza Oliveira
 Gerente de Certificação e Numeração

9.11 CNC Certificate (Argentina) – **MDBT40-P Only**

 <p>Ente Nacional de Comunicaciones Ministerio de Comunicaciones Presidencia de la Nación</p>		
<hr/> <h3>CERTIFICADO DE INSCRIPCIÓN DE MATERIALES</h3> <p>Resolución SC 729/80 – Resolución SC 784/87</p>		
Titular: CH INTERNATIONAL ARGENTINA S.R.L.		
CUIT/CUIL: 30-70878756-2	Expediente: EXPENACOM 1157/2016	
Tipo de Equipo: TRANSEPTOR	Número de Inscripción: C-15824	
Marca: Raytac		
Modelo: MDBT40		
Resolución: 892 ENACOM 2016	Vigencia Desde: 05/04/2016	Hasta: 05/04/2019
<small>Notas: 1) Cada unidad deberá identificarse indicando marca, modelo y número de inscripción, según consta en este certificado. 2) El presente certificado no es transferible.</small>		

9.12 IFETEL Certificate (Mexico) – MDBT40-P Only

UNIDAD DE CONCESIONES Y SERVICIOS DIRECCION GENERAL DE AUTORIZACIONES Y SERVICIOS		 ift INSTITUTO FEDERAL DE TELECOMUNICACIONES	
CERTIFICADO DE HOMOLOGACION Clase: DEFINITIVO Número: RCPRAMD16-0550			
LIC. LUCY LOZANO PEREZ REPRESENTANTE LEGAL DE JF INTERNACIONAL, S.A. DE C.V. Av. Alcanfores No. 16 Col. Jardines de San Mateo C.P. 53240, Naucalpan, Edo. de México			
Fecha de emisión: 7 de abril de 2016		Oficio respuesta a solicitud: IFT/223/UCS/DG-AUSE/1631/2016	
Equipo: Módulo BLUETOOTH 4.1			
Marca: Raytac		Modelo: MDBT40	
Organismo de Certificación: NORMALIZACION Y CERTIFICACION ELECTRONICA S.C. (NYCE)			
Tipo De Certificado: Certificado de Conformidad de producto nuevo en la modalidad prueba de tipo más seguimiento		Número: NYCE/CT/0287/16/TS	
CUMPLIMIENTO NORMATIVO			
NOM-EM-016-SCFI-2015 (Disposición Técnica IFT-008-2015)			
Banda de frecuencias:		2400 - 2483.5 MHz	
Modulación digital Densidad espectral de potencia:		-16.49 dBm/3kHz	
Potencia pico máxima de salida:		0.000 576 W	
Emisiones no esenciales:		<75 nW	
Dictaminó:  JAVIER CASTRO RIVERA		Revisó: El Director de Homologación  ÁNGEL AGUILAR LÓPEZ	
		Autorizó: El Director General  GERARDO LÓPEZ MOOTEZUMA	
Insurgentes Sur 1143, Col. Nochebuena, C.P. 03720 Delegación Benito Juárez, Ciudad de México Tel. (55) 5015 4000			
El presente Certificado está sujeto a las condiciones y notas descritas al reverso de la hoja 1.			
hoja 1 de 1			

CERTIFICADO DE CONFORMIDAD DE PRODUCTO NUEVO EN LA MODALIDAD PRUEBA DE TIPO MÁS SEGUIMIENTO

Certificado No.: **NYCE/CT/0287/16/TS**

Con fundamento en lo establecido en los artículos 3 fracciones I, III, IV-A, XII, XV-A, 38 fracción VI, 52, 53 párrafos primero y segundo, 68, 70C fracciones I, II, III, IV y V, 73, 74, 76, 79 y 80 de la Ley Federal sobre Metrología y Normalización; 80, 83, 87 y 88 del Reglamento de la Ley Federal sobre Metrología y Normalización; Normalización y Certificación Electrónica S.C. (NYCE), otorga el presente certificado de conformidad con la(s) **NOM-EM-016-SCFI-2015**; a:

con domicilio en: **JF INTERNACIONAL SA DE CV**
AV. ALCANFORES NO 16 COL.: JARDINES DE SAN MATEO
C.P. 53240 NAUCALPAN DE JUAREZ, EDO MEX
R.F.C. JIN0204309V4

Para el (los) siguiente (s)

Producto(s):	MODULO BLUETOOTH 4.1
Marca:	Raytac
Modelo (s):	MDBT40
País(es) de fabricación o de ensamblado final:	TAIWAN
País(es) de procedencia:	TAIWAN

Con base en el (los) informe(s) de pruebas **IV-031-16** emitido(s) por el (los) laboratorio(s) de pruebas **INGENIERIA Y VERIFICACIÓN DE EQUIPOS Y SISTEMAS DE TELECOMUNICACIONES SA DE CV (IVESTEL)**; con acreditación(es) **EE-087-004/09**, con aprobación(es) **EE-087-004/09**, y con autorización(es) por parte del **Instituto Federal de Telecomunicaciones (IFT)**, de conformidad con lo establecido en la Ley Federal sobre Metrología y Normalización y su Reglamento; en el procedimiento PCPPCT2E de NYCE y a la solicitud con No. de referencia **STOC0357-16**.
El presente certificado de conformidad se expide en México, D.F., el día **29-marzo-2016**; la vigencia de este certificado estará sujeta a los seguimientos respectivos de acuerdo con la Ley Federal sobre Metrología y Normalización y demás disposiciones legales aplicables y deberá constatarse en las listas de certificados de conformidad vigentes que mantiene NYCE S.C.

ATENTAMENTE



EN CASO DE EXISTIR UNA CONTROVERSI A,
NYCE, S.C. ÚNICAMENTE RESPALDARA EL
ORIGINAL DEL CERTIFICADO

JUAN PABLO NAVA CRUBE
DIRECTOR DE OPERACIONES

Certificó: 
Adrián López Hernández

Analizó: 
Ramón España Silva

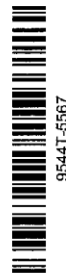

9.13 RoHS & RoHS Report

Please visit "[Support](#)" page of our website.

9.14 Reliability Test

Below are the extracted events from reliability test. Please contact us for full report.

- Tested Item: MDBT40 / MDBT40-P
- Testing Method:
Conducted continuously BLE transmitting and receiving function checking during requested duration.
- Testing Result: No fault or package loss during testing.
- Testing Events:
 1. Operating under Low Temperature Test

Test Method/ Specification:

Test method:	<u>Refer to JASO D001-94, Clause 5.13</u>
Sample condition:	<u>Operating</u>
Temperature:	<u>-30°C</u>
Duration:	<u>72 Hours</u>

2. Operating under High Temperature Test

Test Method/ Specification:

Test method:	<u>Refer to JASO D001-94, Clause 5.15</u>
Sample condition:	<u>Operating</u>
Temperature:	<u>85°C</u>
Duration:	<u>120 Hours</u>

3. Thermal Shock Test

Test Method/ Specification:

Test method: Refer to JASO D001-94, Clause 5.17

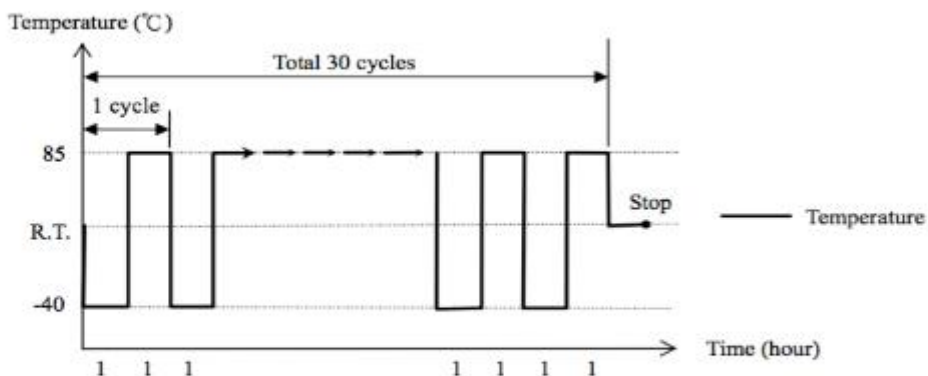

- Sample Condition: Operating
- The temperature transition time shall be within 1 minute.
- Examine the appearance of specimen(s) by visual check and perform functional check after this test.
- Functional check: Connect the specimen(s) with notebook and rated power ($2V_{DC}$) then examine whether the signal transmission could be work normally or not.

4. Temperature Cycling Test

1. Temperature Cycling Test:

Test Equipment:

Name	Brand	Model	Serial No.
Programmable Temperature & Humidity Chamber	KSON	THS-D4T-150-LN2	D129
Programmable DC Power Supply	GW	PSM-2010	PH220347

Lab Environmental Conditions:

Ambient Temperature: $(25 \pm 3) ^\circ\text{C}$

Ambient humidity: $(55 \pm 20) \% \text{RH}$

Test Method/ Specification:

Condition I:

Test method: Refer to JASO D001-94, Clause 5.18

Step	Temperature ($^\circ\text{C}$)	Humidity (%RH)	Time (hours)	Sample Condition
1	23	60	4	Operating
2	23→55	60→95	0.5	Operating
3	55	95	10	Operating
4	55→-40	95→0	2.5	Non-Operating
5	-40	0	2	Non-Operating
6	-40→85	0	1.5	Non-Operating
7	85	0	2	Operating
8	85→23	0	1.5	Operating

Test cycle: Total 10 cycles.

- Examine the appearance of specimen(s) by visual check and perform functional check after this test.
- Functional check: Connect the specimen(s) with notebook and rated power ($2V_{DC}$) then examine whether the signal transmission could be work normally or not.

Condition II:

Test method: Refer to JASO D001-94, Clause 5.18

Step	Temperature ($^\circ\text{C}$)	Humidity (%RH)	Time (hours)	Sample Condition
1	23	60	4	Operating
2	23→55	60→95	0.5	Operating
3	55	95	10	Operating
4	55→-40	95→0	2.5	Operating
5	-40	0	2	Operating
6	-40→85	0	1.5	Operating
7	85	0	2	Operating
8	85→23	0	1.5	Operating

Test cycle: Total 1 cycle.

Note: Condition II is start after Condition I complete

- Examine the appearance of specimen(s) by visual check and perform functional check after this test.
- Functional check: Connect the specimen(s) with notebook and rated power ($2V_{DC}$) then examine whether the signal transmission could be work normally or not.

9.15 End-Product Label

It is suggested using following content adding to package or user manual or label to obey the regulation. Any rules of end-product label shall refer to each certification for final reference

9.15.1 FCC (USA)

The FCC statement should be included in the user manual when there is no enough space on label. Otherwise, it should be included on the label.

“This device complies with part 15 of the FCC rules. Operation is subject to the following two conditions. (1) This device may not cause harmful interference. (2) This device must accept any interference received, including interference that may cause undesired operation.”

The final end product must be labeled in a visible area with the following: “Contain FCC ID: SH6MDBT40”.

9.15.2 TELEC (Japan)

When manufacturer is placing the product on the Japanese market, the product must be affixed with the following Specified Radio Equipment marking:



9.15.3 NCC (Taiwan)

請依下列標籤式樣自製標籤，標貼或印鑄於器材本體明顯處，始得販賣或公開陳列。

MDBT40 Series



MDBT40-P Series



平台廠商必須於平台上標示字樣「本產品內含射頻模組：ID 編號 CCAF15LP0280T1」或「本產品內含射頻模組：ID 編號 CCAM15LP0230T1」。

「平台」定義如下：若器材組裝本案模組，消費者仍能正常使用該器材主要功能，該器材得視為平台。若器材不組裝本案模組，消費者不能正常使用該器材主要功能，該器材不能視為平台。該類不同廠牌型號器材組裝本案審驗模組後，須分別申請型式認證。

9.15.4 IC (Canada)

The IC statement should be included in the user manual when there is no enough space on label. Otherwise, it should be included on the label.

“This device complies with Industry Canada license-exempt RSS Standard(s). Operation is subject to the following two conditions. (1) This device may not cause harmful interference. (2) This device must accept any interference received, including interference that may cause undesired operation.

Le présent appareil est conforme aux CNR d'Industrie Canada applicables aux appareils radio exempts de licence. L'exploitation est autorisée aux deux conditions suivantes: (1) l'appareil ne doit pas produire de brouillage, et (2) l'utilisateur de l'appareil doit accepter tout brouillage radioélectrique subi, même si le brouillage est susceptible d'en compromettre le fonctionnement.”

The final end product must be labeled in a visible area with the following: “Contain IC ID: 8017A-MDBT40.

10. Notes and Cautions

Module is not designed to be used and lasting a lifetime. Like general products, it is expected to be worn out after continuous usage through the years. To assure that product will perform better and last longer, please

- Follow the guidelines of this document while designing circuit/end-product. Any discrepancy of core Bluetooth technology and technical specification of IC should refer to definition of Bluetooth Organization and Nordic Semiconductor as final reference.
- Do not supply voltage that is not within range of specification.
- Eliminate static electricity at any methods when working with the module as it may cause damage. It is highly recommended adding anti-ESD components to circuit design to prevent damage from real-life ESD events. Anti-ESD methods can be also applied in mechanical design.
- Do not expose modules under direct sunlight for long duration. Modules should be kept away from humid and salty air conditions, and any corrosive gasses or substances. Store it within -40°C to $+125^{\circ}\text{C}$ before and after installation.
- Avoid any physical shock, intense stress to the module or its surface.
- Do not wash the module. No-Clean Paste is used in production. Washing process will oxidize the metal shield and have chemistry reaction with No-Clean Paste. Functions of the module are not guaranteed when it goes through washing process.

The module is not suitable for life support device or system and not allowed to be used in destructive device or system in any direct, or indirect ways. The customer is agreeing to indemnify Raytac for any losses when applying modules under such application as described above.

11. Useful Links

- **Nordic Infocenter:** <https://infocenter.nordicsemi.com/index.jsp>
All the necessary technical files and software development kits of Nordic's chip are on this website.
- **Nordic Developer Zone:** <https://devzone.nordicsemi.com/questions/>
A highly recommended website for firmware developer. Interact with other developers and Nordic's employees will help with your questions. The site also includes tutorials in detail to help you get started.
- **Official Page of nRF51822:**
<https://www.nordicsemi.com/eng/Products/Bluetooth-low-energy/nRF51822>
A brief introduction to nRF51822 and download links for Nordic's developing software and SoftDevices.



Full List of Raytac's BLE Modules

Raytac Corporation Bluetooth Module Family

Copyright © All Rights Reserved.

Solution By:



MDBT40 & MDBT40-P Series

Series	Nordic Solution	Raytac No.	IC Version	Antenna	RAM	Flash Memory
MDBT40	nRF51822	MDBT40-256V3	3	Chip Antenna	16 kb	256 K
		MDBT40-256RV3			32 kb	256 K
MDBT40-P	nRF51822	MDBT40-P256V3	3	PCB Antenna	16 kb	256 K
		MDBT40-P256RV3			32 kb	256 K
MDBT40 - ANT	nRF51422	MDBT40-ANT-256V3	3	Chip Antenna	16 kb	256 K
		MDBT40-ANT-256RV3			32 kb	
MDBT40 - ANT-P	nRF51422	MDBT40-ANT-P256V3	3	PCB Antenna	16 kb	256 K
		MDBT40-ANT-P256RV3			32 kb	
MDBT40 Nano	nRF51822	MDBT40-n256V3	3	N/A	16 kb	256 K
MDBT40 - ANT-Nano	nRF51422	MDBT40-ANT-n256V3	3	N/A	16 kb	256 K

MDBT42Q Series (QFN Package IC)

Series	Nordic Solution	Raytac No.	IC Version	Antenna	RAM	Flash Memory
MDBT42Q	nRF52832	MDBT42Q-512KV2	2	Chip Antenna	64 kb	512 K
	nRF52810	MDBT42Q-192K	1		24 kb	192 K

MDBT42Q-P	nRF52832	MDBT42Q-P512KV2	2	PCB Antenna	64 kb	512 K
	nRF52810	MDBT42Q-P192K	1		24 kb	192 K

MDBT42 Series (WLCSP Package IC)

Series	Nordic Solution	Raytac No.	IC Version	Antenna	RAM	Flash Memory
MDBT42	nRF52832	MDBT42-512KV2	2	Chip Antenna	64 kb	512 K
MDBT42-P		MDBT42-P512KV2		PCB Antenna		

Series	Nordic Solution	Raytac No.	IC Version	Antenna	RAM	Flash Memory
MDBT42V	nRF52832	MDBT42V-512KV2	2	Chip Antenna	64 kb	512 K
MDBT42V-P		MDBT42V-P512KV2		PCB Antenna		

MDBT50Q Series (aQFN Package IC)

Series	Nordic Solution	Raytac No.	IC Version	Antenna	RAM	Flash Memory
MDBT50Q	nRF52840	MDBT50Q-1M	1	Chip Antenna	256 kb	1MB
MDBT50Q-P		MDBT50Q-P1M		PCB Antenna		
MDBT50Q-U		MDBT50Q-U1M		u.FL Connector		

Release Note

- 2015/02/13 Version A1: NCC certificate in Chapter 10 added.
- 2015/04/29 Version A2:
 - (1) Added MDBT40-P Spec, RoHS Report, List of Raytac's Model No.
 - (2) Updated Chapter 8, 9, and 12, 13.
- 2015/07/01 Version A3: Adding IC & SRRC certificates.
- 2015/11/03 Version A4:
 - (1) Revised layout guide for MDBT40 series in Chapter 2.
 - (2) Updated Chapter 5.
 - (3) Updated List of Raytac's Model No.
 - (4) Removed info of V2 module from Chapter 4.
 - (5) Added Reliability Test in Chapter 10.
- 2017/01/16 Version A5:
 - (1) Updated List of Raytac no., Chapter 2, 4, and 12.
 - (2) Added KC certificate, RoHS & REACH reports and updated others in Chapter 9.
- 2017/05/19 Version A6:
 - (1) Updated List of Raytac's Model No., link for footprint & design guide in Chapter 4.
 - (2) Updated CE reports to new RED directives.
- 2017/07/19 Version A7:
 - (1) Updated chapter 2.3 & 2.4, and full list of Raytac's BLE modules.
- 2018/06/14 Version A8:
 - (1) Updated spec on 1.2 features and Chapter 5: Specification
 - (2) Updated link for 2018 RoHS & REACH reports.
 - (3) Replaced Chapter 10: Current Consumption Reference Data with Notes and Cautions; Chapter 11: BT 4.1 Product Certification Cost Comparison Chart with Useful Links.
 - (4) Removed Chapter 12: nRF51 IC Compatibility with SDK & Softdevice.
- 2018/11/15 Version A9:
 - (1) Added Mesh Profile in Chapter 1.3: Profile & Service Information.
 - (2) Updated drawing in Chapter 2.3 and link of footprint & design guide in Chapter 2.4.
 - (3) Updated Chapter 4 by removing info of MDBT40-128V3 /P128V3 and adding tray info.
 - (4) Updated technical spec in Chapter 5 by adding source of reference.

- (5) Added new SIG BT 4.2 certification info, RCM report, ANATEL (Brazil) certificate, CNC (Argentina), IFETEL (Mexico) certificate and updated link of RoHS & REACH reports in Chapter 9.
- (6) Added “no-washing” warning in Chapter 10.

