

SF2275E-1

1542 MHz SAW Filter

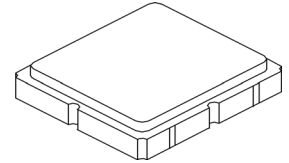

SM3030-6

- 1542.5 MHz Low-loss SAW Filter
- Surface Mount 3.0 x 3.0 Package
- Complies with Directive 2002/95/EC (RoHS)
- Moisture Sensitivity Level: 1
- AEC-Q200 Qualified

Absolute Maximum Rating	Value	Units
Input Power Level	15	dBm
DC Voltage on any Non-ground Terminal	5	V
Specification Temperature Range	-40 to +105	°C
Storage Temperature Range in Tape and Reel	-40 to +85	°C
Operable Temperature Range	-40 to +125	°C
Solder Reflow Temperature, 10 seconds, 5 cycles maximum	260	°C

Electrical Characteristics

Characteristic	Sym	Notes	Min	Typ	Max	Units
Center Frequency	f_c			1542		MHz
3 dB Bandwidth				50		
Insertion Loss, 1525 to 1559 MHz	IL			2.8	3.0	dB
Return Loss				10		dB
Amplitude Ripple, 1525 to 1559 MHz				1.6	2.0	dB _{p-p}
Group Delay Ripple 1525 to 1559 MHz (2 MHz sliding window) 1525 to 1559 MHz (total pass band)				8	10.0	ns
				21	25.0	
Attenuation, Referenced to 0 dB	0.3 to 1300 MHz		30	37		dB
	1300 to 1480 MHz		25	39		
	1630 to 3500 MHz		30	32		
	3500 to 5000 MHz			28		
	5000 to 6000 MHz			16		
Source Impedance	Z_s			50		Ω
Load Impedance	Z_L			50		
Case Style	SM3030-6 3.0 x 3.0 mm Nominal Footprint					
Lid Symbolization (Y=year, WW=week, S=shift) dot=pin 1 indicator	8U, YWWS					
Standard Reel Quantity	Reel Size 7 Inch					500 Pieces/Reel
	Reel Size 13 Inch					3000 Pieces/Reel

Electrical Connections

Connection	Terminals
Input	2
Output	5
Ground	All Others

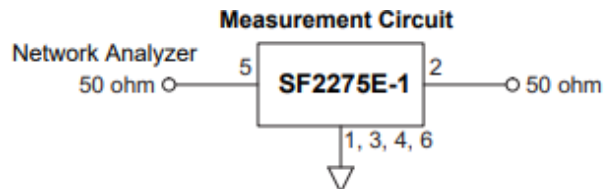

Frequency Characteristics

Wideband Response: (0.3 to 3500 MHz)

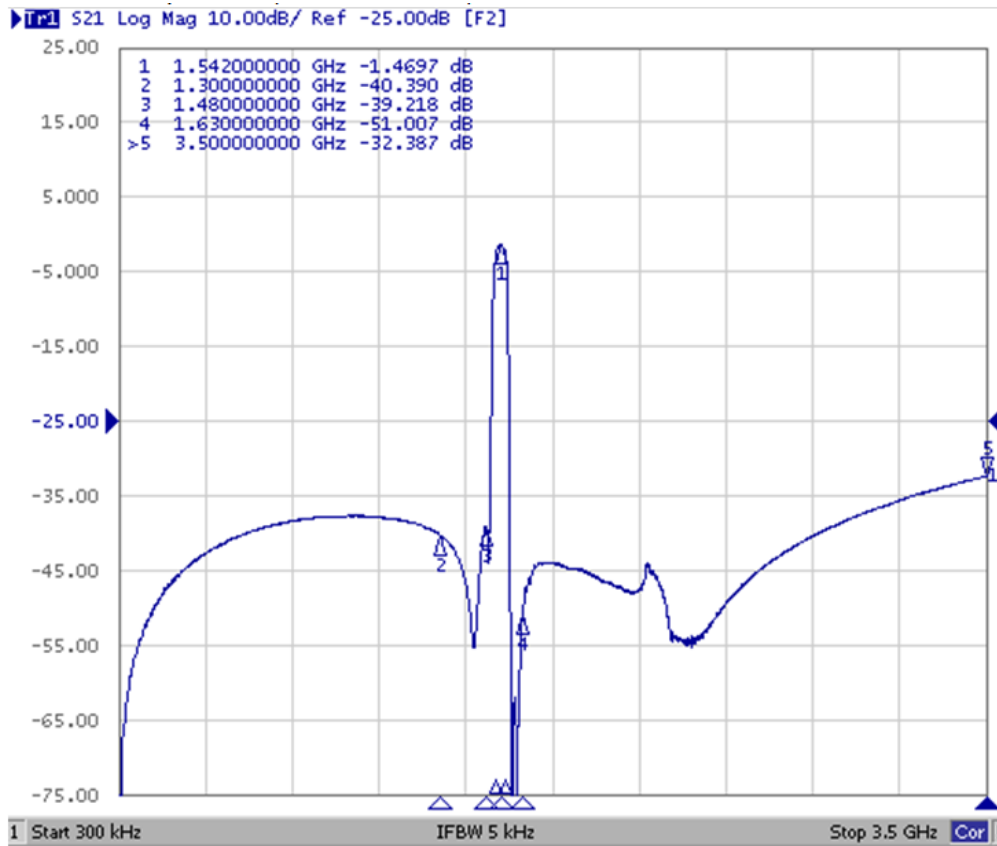

Narrowband Response: (span 200 MHz)

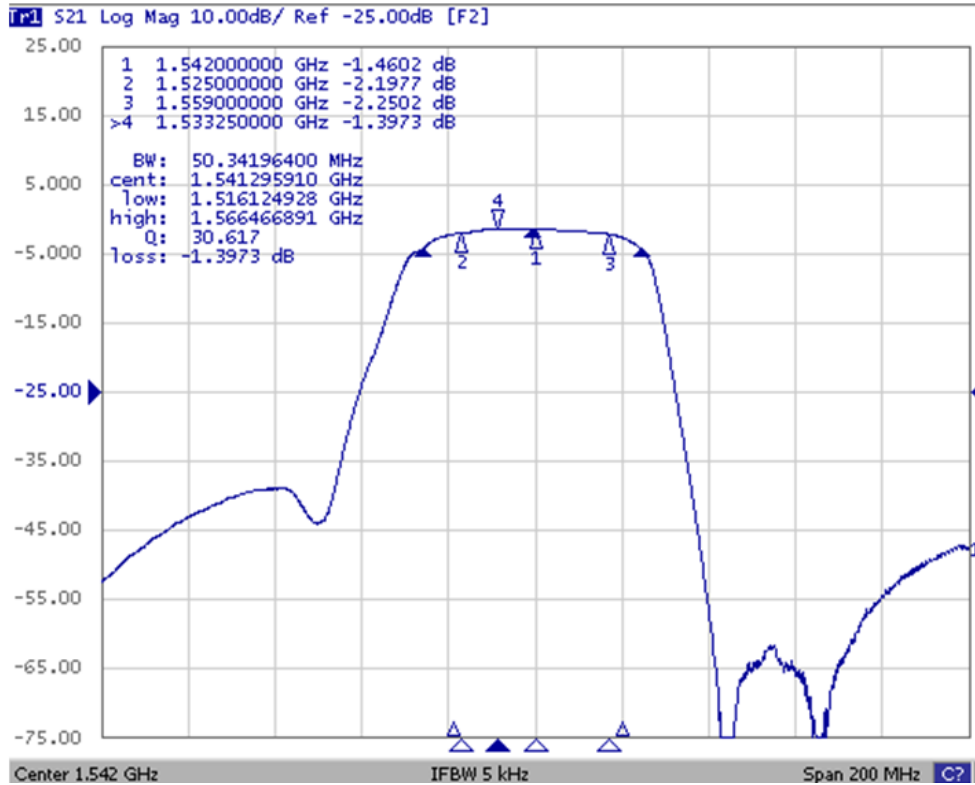

Frequency Characteristics

VSWR (span 200 MHz)

S11

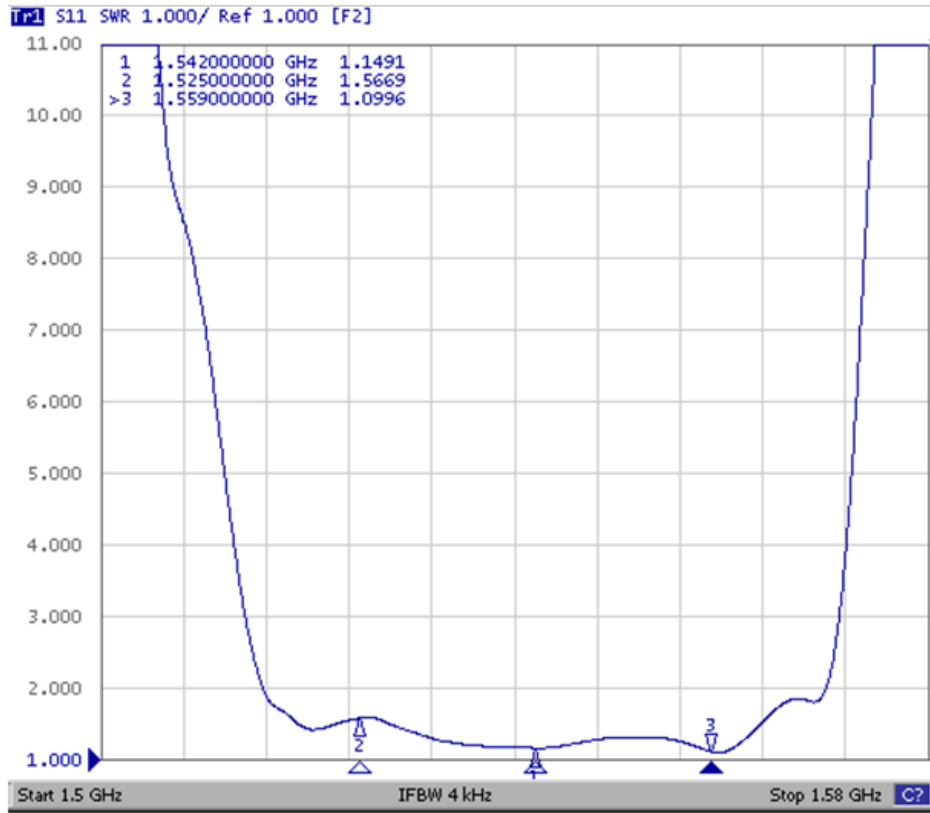

S22

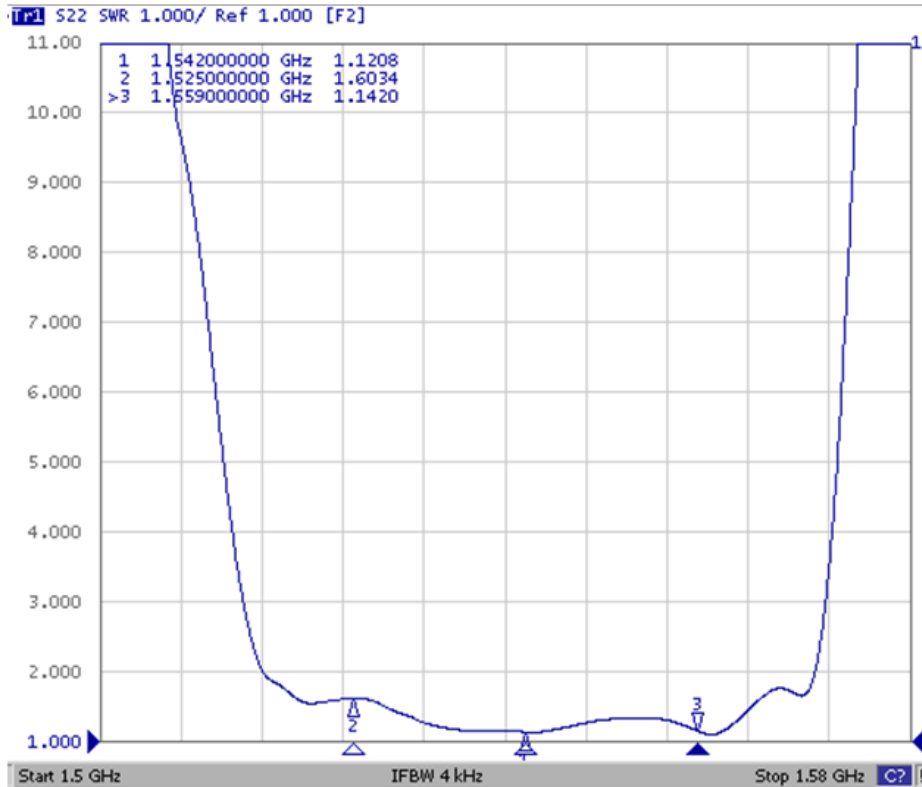

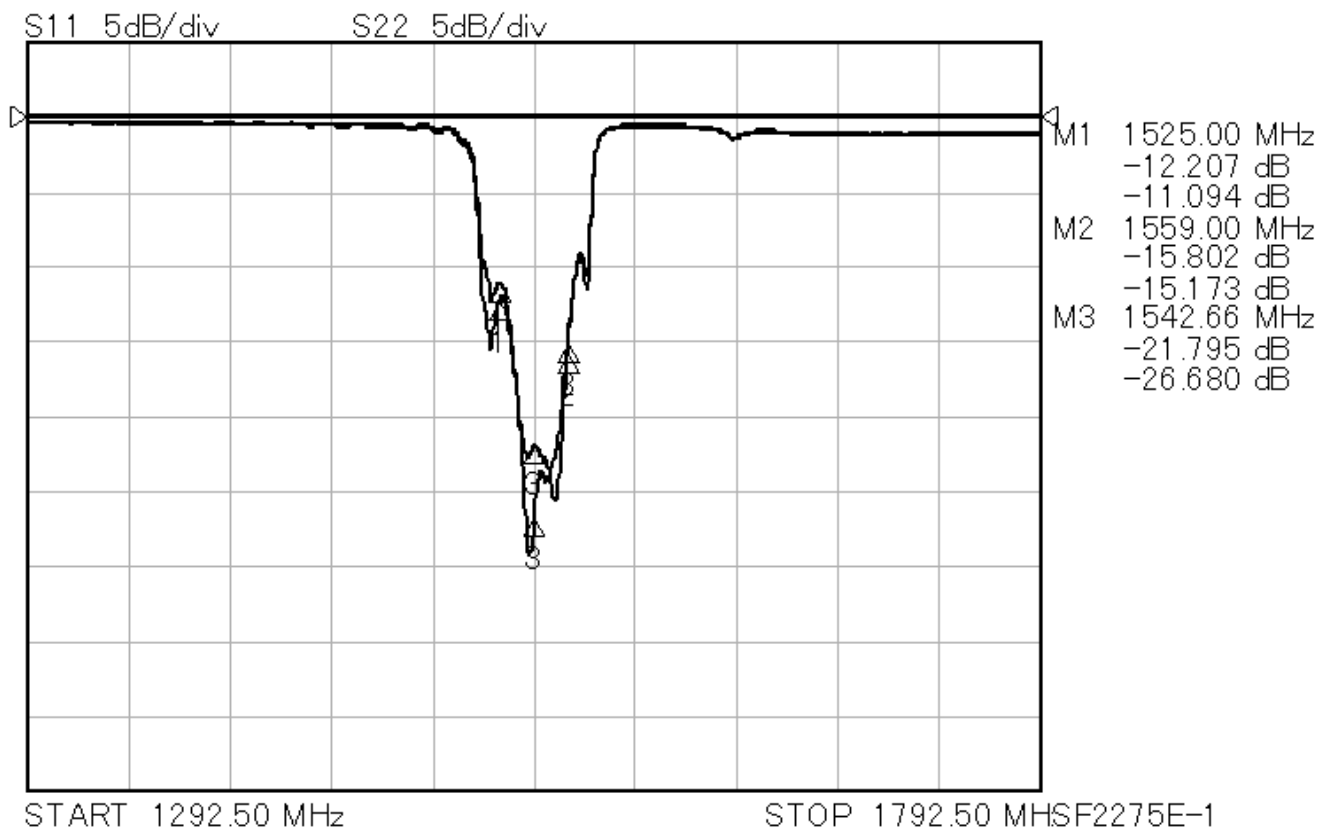
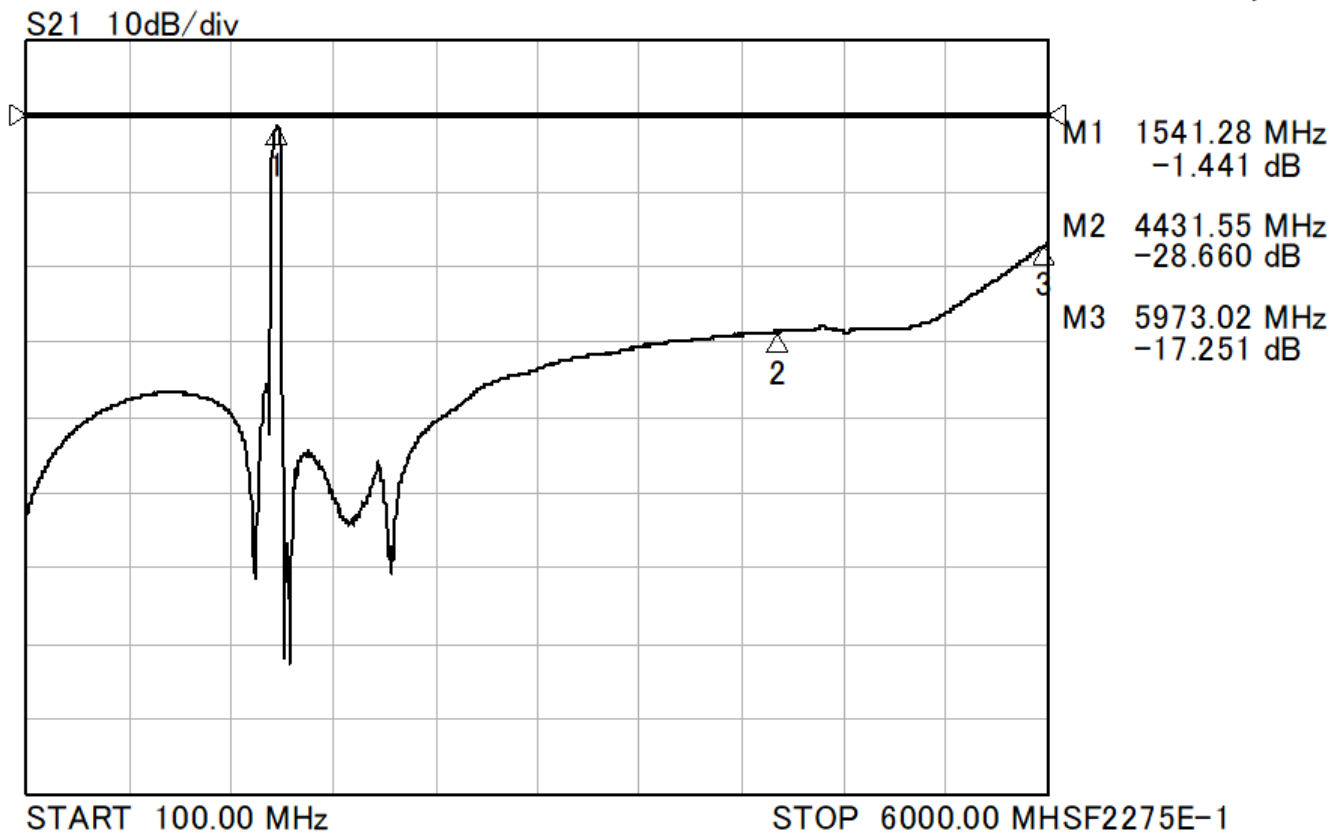

SM3030-6 Case

6-Terminal Ceramic Surface-Mount Case 3.0 X 3.0 mm Nominal Footprint

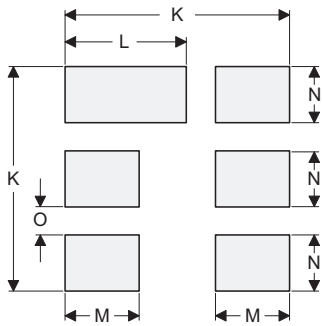
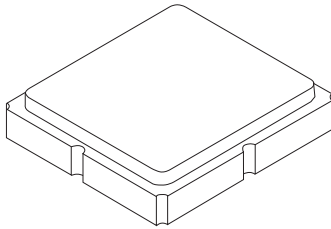

PCB Land Pattern
Top View

Case and PCB Footprint Dimensions

Dimension	mm			Inches		
	Min	Nom	Max	Min	Nom	Max
A	2.87	3.00	3.13	0.113	0.118	0.123
B	2.87	3.00	3.13	0.113	0.118	0.123
C	1.12	1.25	1.38	0.044	0.049	0.054
D	0.77	0.90	1.03	0.030	0.035	0.040
E	2.67	2.80	2.93	0.105	0.110	0.115
F	1.47	1.60	1.73	0.058	0.063	0.068
G	0.72	0.85	0.98	0.028	0.033	0.038
H	1.37	1.50	1.63	0.054	0.059	0.064
I	0.47	0.60	0.73	0.019	0.024	0.029
J	1.17	1.30	1.43	0.046	0.051	0.056
K		3.20			0.126	
L		1.70			0.067	
M		1.05			0.041	
N		0.81			0.032	
O		0.38			0.015	
P	0.15	0.30	0.45	0.005	0.011	0.017
Q	0.07	0.20	0.36	0.002	0.007	0.014
R	0.62	0.7	0.78	0.024	0.027	0.030

Case Materials

Materials	
Solder Pad Plating	0.3 to 1.0 μm Gold over 1.27 to 8.89 μm Nickel
Lid Plating	2.0 to 3.0 μm Nickel
Body	Al_2O_3 Ceramic

TOP VIEW

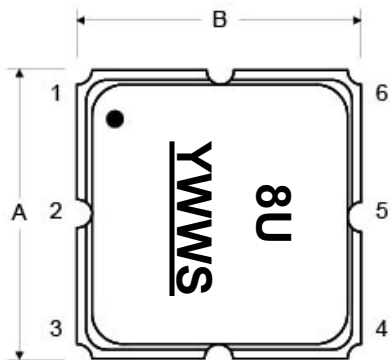

BOTTOM VIEW

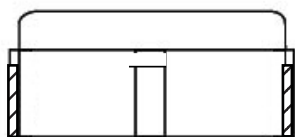
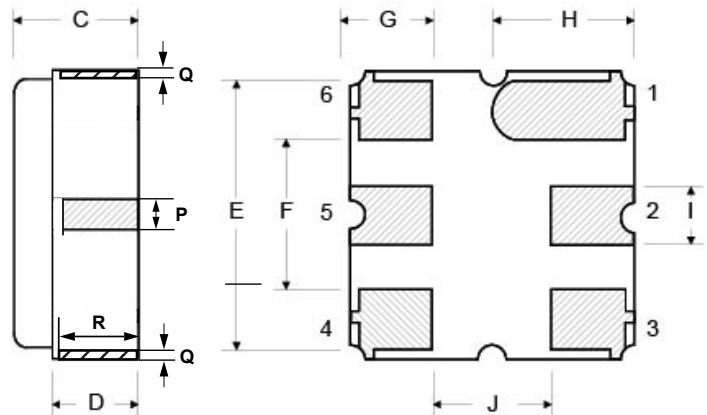

Recommended Reflow Profile

1. Preheating shall be fixed at 150~180°C for 60~90 seconds.
2. Ascending time to preheating temperature 150°C shall be 30 seconds min.
3. Heating shall be fixed at 220°C for 50~80 seconds and at 260°C +0/-5°C peak (10 seconds).
4. Time: 5 times maximum.

