

**SF2281D**

**313.15/314.00 MHz  
Dual SAW Filter**

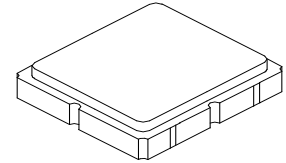

**SM3838-8**

- **Low Insertion Loss Dual SAW Filter**
- **3.8 x 3.8 mm Surface-mount Case**
- **Single-ended Input and Output**
- **Complies with Directive 2002/95/EC (RoHS)**
- **Moisture Sensitivity Level: 1**
- **AEC-Q200 Qualified**

**Absolute Maximum Ratings**

Rating	Value	Units
Maximum Input Power	+10	dBm
Maximum DC Voltage Between any Two Terminals	3	VDC
Storage Temperature Range in Tape and Reel	-40 to +85	°C
Operating Temperature Range	-40 to +85	°C
Suitable for Lead-free Soldering - Maximum Soldering Profile	260 °C for 30 s	

**Electrical Characteristics**

Characteristic	Sym	Note	Min	Typ	Max	Units
Band 1 Center Frequency	$f_{C1}$			313.15		MHz
Band 1 Insertion Loss, 313.05 to 313.25 MHz				3.5	4.5	dB
Band 1 Amplitude Ripple, 313.05 to 313.25 MHz				0.7	1.2	dB
Band 1 VSWR, 313.05 to 313.25 MHz				1.6	2.3	
Band 1 Attenuation Referenced to 0 dB:						dB
313.90 to 314.10 MHz			26	30		
$f_{C1} + 2.00$ MHz			25	30		
$f_{C1} - 2.00$ MHz			30	35		
Band 2 Center Frequency	$f_{C2}$			314.00		MHz
Band 2 Insertion Loss, 313.90 to 314.10 MHz				3.5	4.5	dB
Band 2 Amplitude Ripple, 313.90 to 314.10 MHz				0.5	1.2	dB
Band 2 VSWR, 313.90 to 314.10 MHz				1.6	2.3	
Band 2 Attenuation Referenced to 0 dB:						dB
313.05 to 313.25 MHz			26	30		
$f_{C2} + 2.00$ MHz			25	30		
$f_{C2} - 2.00$ MHz			30	35		

Case Style	SM3838-8 3.8 x 3.8 mm Nominal Footprint		
Lid Symbolization (Y=year, WW=week, S=shift) dot=pin 1 indicator	A28, <u>YWWS</u>		
Standard Reel Quantity	Reel Size 7 Inch	500 Pieces/Reel	
	Reel Size 13 Inch	3000 Pieces/Reel	

 **CAUTION: Electrostatic Sensitive Device. Observe precautions for handling.**  
**NOTES:**

1. The design, manufacturing process, and specifications of this device are subject to change.
2. US or International patents may apply.
3. RoHS compliant from the first date of manufacture.

# Measurement Circuit

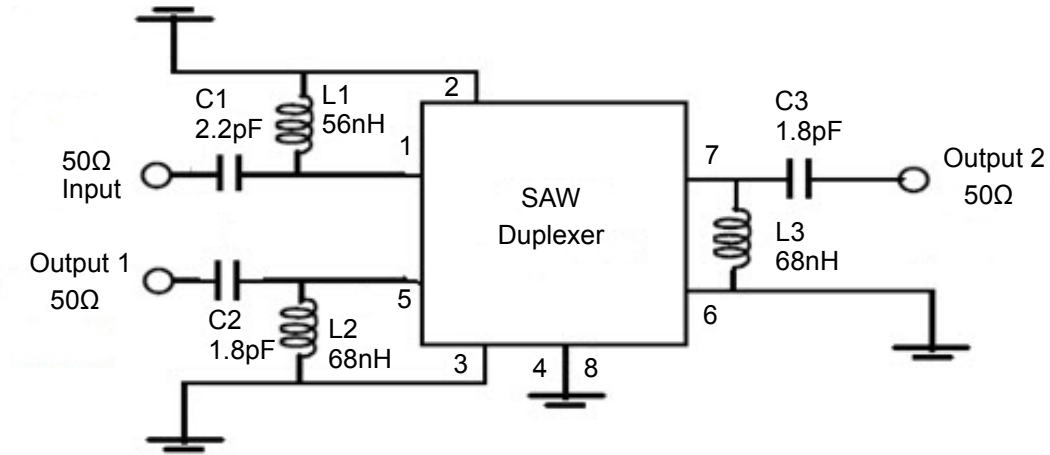

# Frequency Characteristics

S21: Span 5MHz

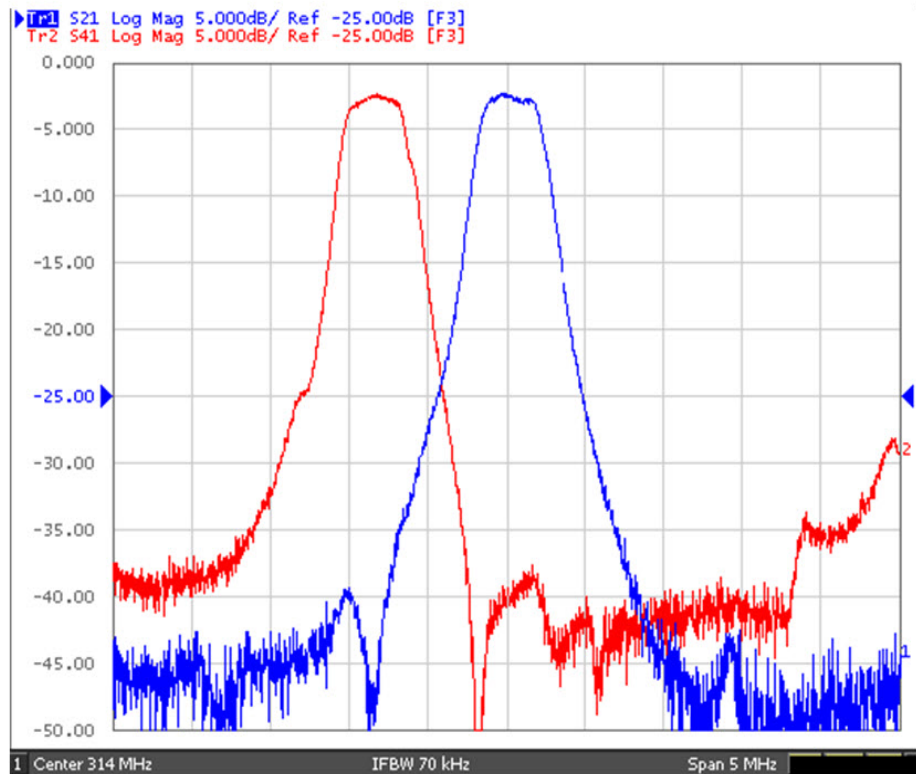

## S21: Span 5MHz

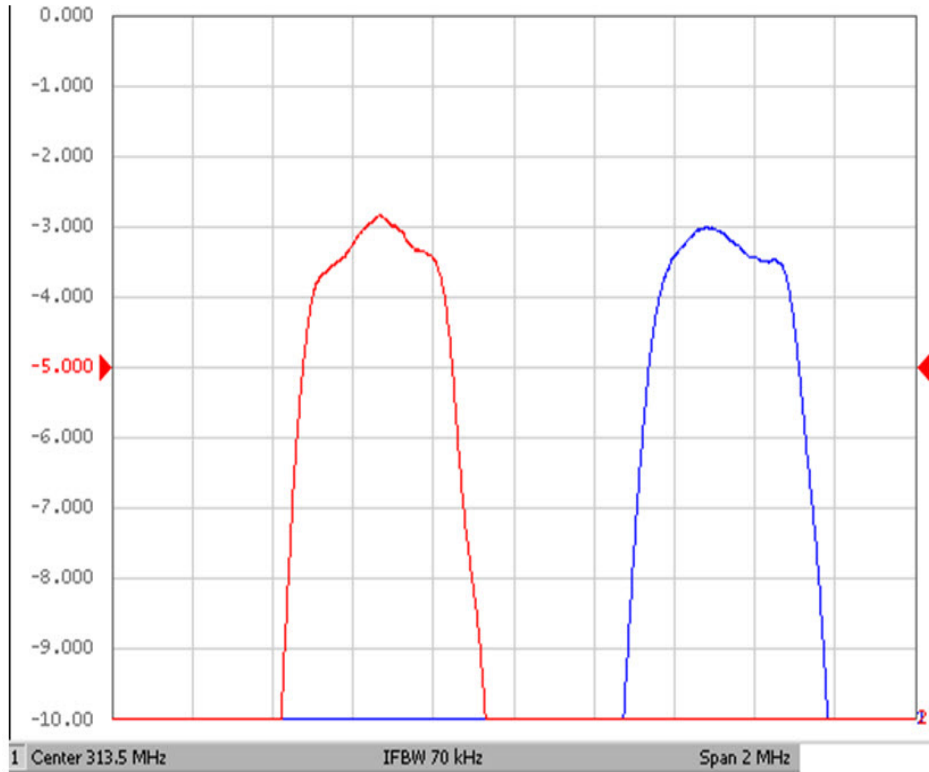

## S21: Span 20MHz

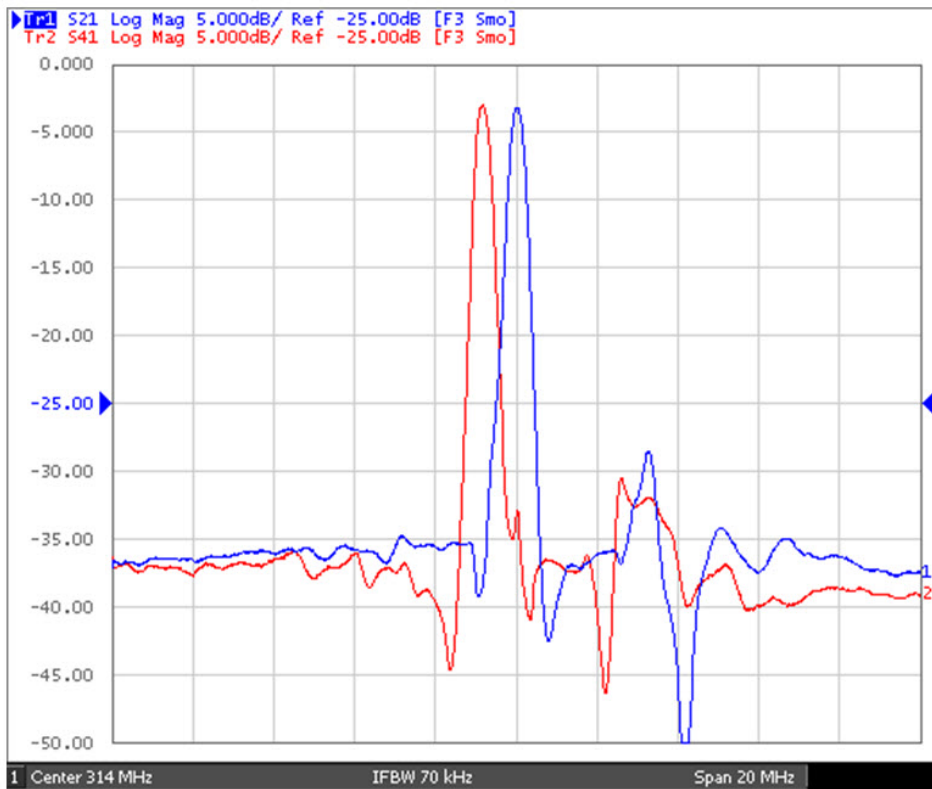

## S11 (I/P)

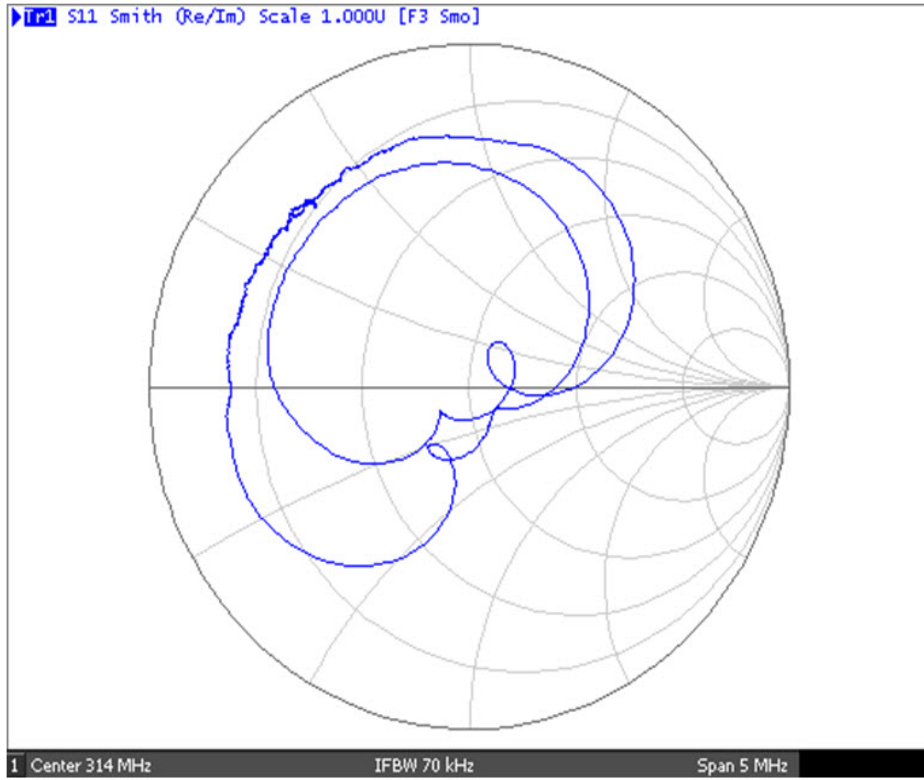

## S22: (O/P-2)

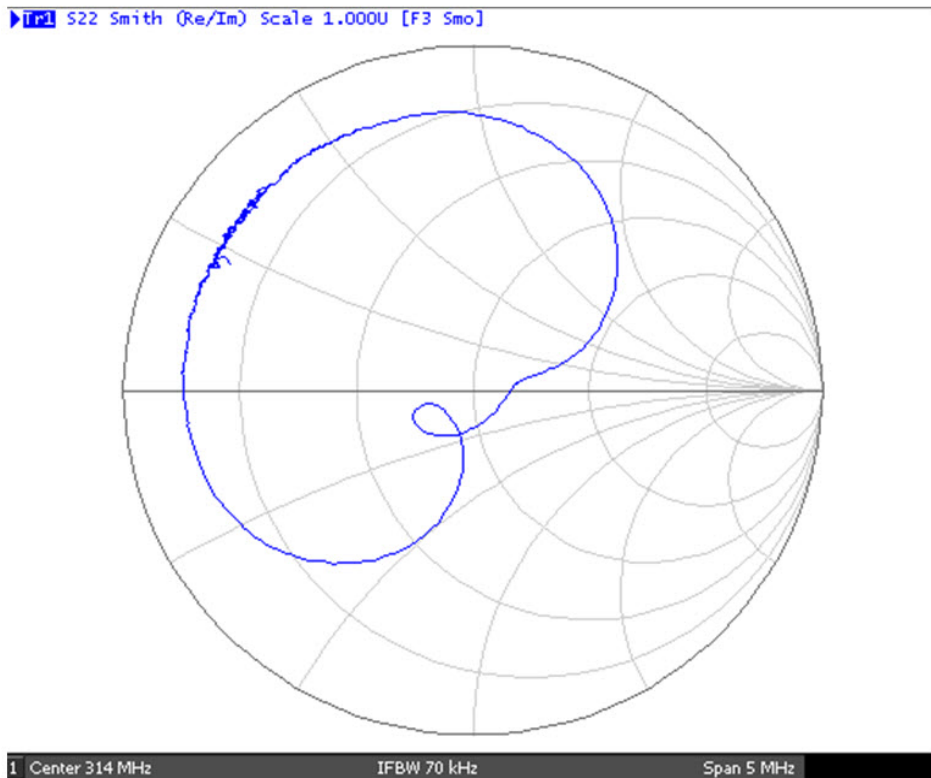

## S44 (O/P\_1)

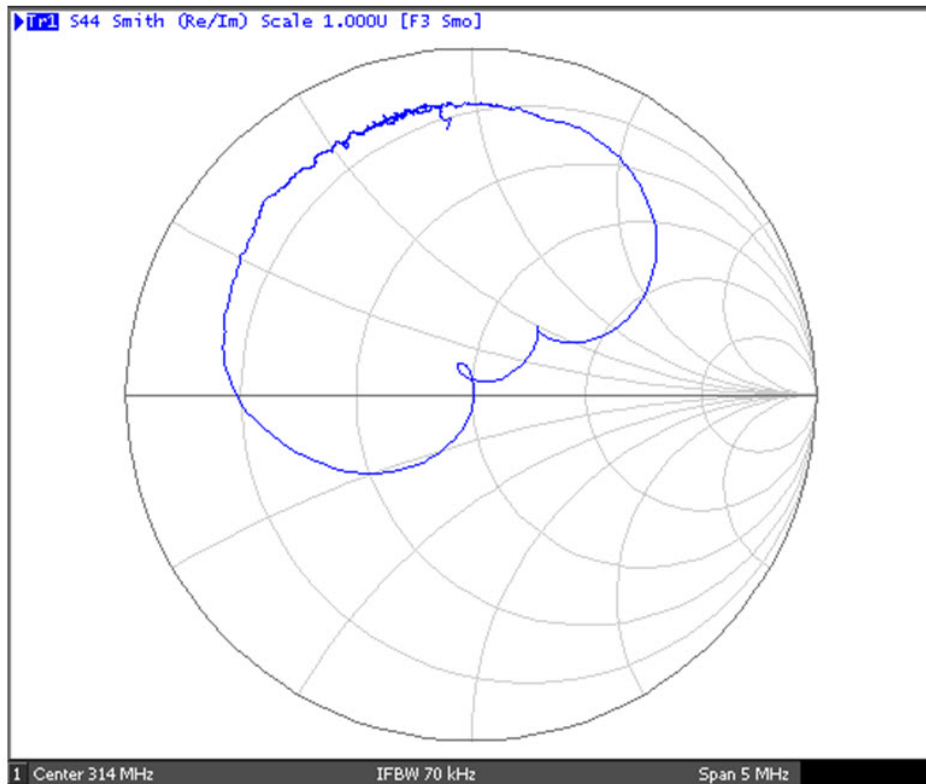

# SM3838-8 Case

## 8-Terminal Ceramic Surface-mount Case

### 3.8 X 3.8 mm Nominal Footprint

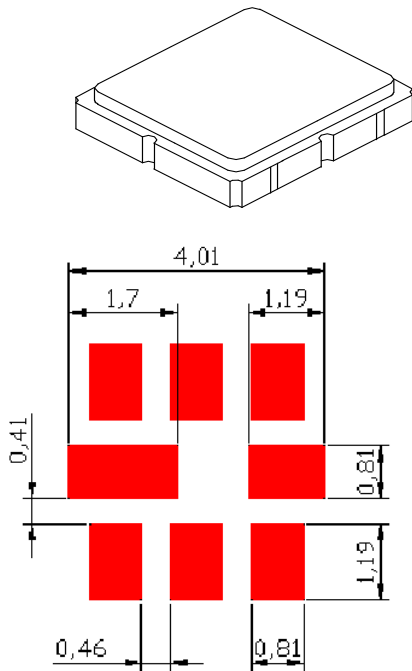

Typical PCB Footprint

#### Case Dimensions

Dimension	mm			Inches		
	Min	Nom	Max	Min	Nom	Max
A	3.6	3.8	4.0	0.142	0.150	0.157
B	3.6	3.8	4.0	0.142	0.150	0.157
C	1.05	1.20	1.40	0.041	0.047	0.055
D	0.95	1.10	1.25	0.037	0.043	0.049
E	0.90	1.00	1.10	0.035	0.040	0.043
F	0.50	0.60	0.70	0.020	0.024	0.028
G	2.39	2.54	2.69	0.090	0.100	0.110
H	-	1.50	-	-	0.069	-

#### Electrical Connections

Pin	Connection
1	Input
2,3,6	RF Ground
4,8	Case Ground
5	Band 1 Output
7	Band 2 Output

Dot Indicates Pin 1

#### Materials

Solder Pad Plating	0.3 to 1.0 $\mu\text{m}$ Gold over 1.27 to 8.89 $\mu\text{m}$ Nickel
Lid Plating	2.0 to 3.0 $\mu\text{m}$ Nickel
Body	$\text{Al}_2\text{O}_3$ Ceramic

#### TOP VIEW

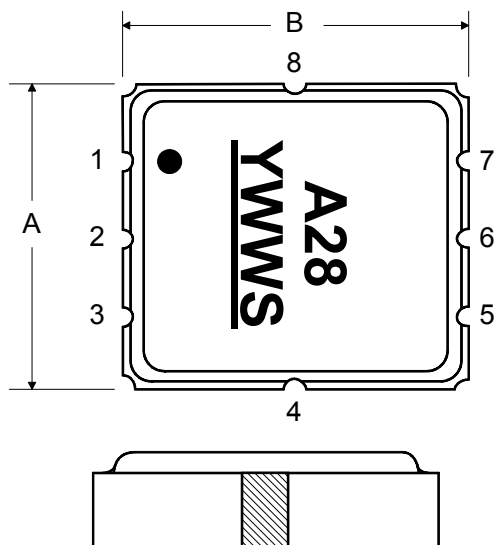

#### BOTTOM VIEW

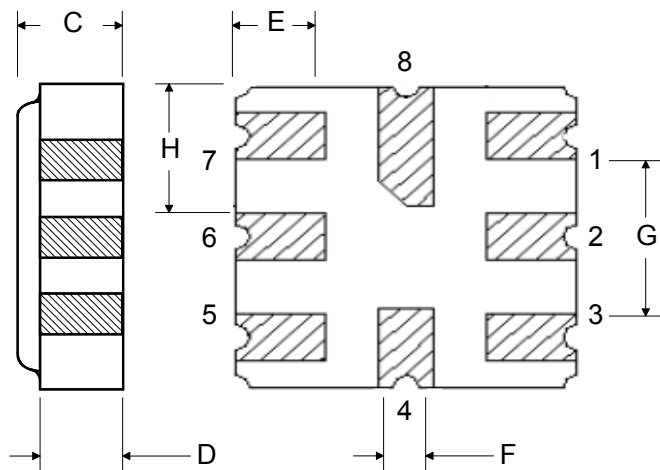



## Recommended Reflow Profile

1. Preheating shall be fixed at 150~180°C for 60~90 seconds.
2. Ascending time to preheating temperature 150°C shall be 30 seconds min.
3. Heating shall be fixed at 220°C for 50~80 seconds and at 260°C +0/-5°C peak (10 seconds).
4. Time: 5 times maximum.

