

IntelliMAX™ Advanced Load Products

FPF1007 - FPF1009

General Description

The FPF1007/8/9 are low R_{DS} P-Channel MOSFET load switches offered in a selection of 10 μ s, 80 μ s, and 1 ms slew rate turn-on options for transient / in-rush current control. To support trends in mobile application requirements, the minimum operating input voltage has been reduced down to 1.2 V, the input current leakage has been minimized to extend battery life, and the ESD-protection has been designed to withstand a minimum of 8 kV (HBM) and 2 kV (CDM).

The switch is controlled by an active-high logic input (ON pin), allowing direct interface with a low-voltage control signal. An internal ON pin pull-down resistor protects against unintentional device turn-on in the initial state. An on-chip pull-down resistor on the output is enabled when the switch is turned-off and provides quick, robust discharge of the output load.

Features

- 1.2 to 5.5 V Input Voltage Range
- Typical $R_{ON} = 30\text{ m}\Omega$ at $V_{IN} = 5.5\text{ V}$
- Typical $R_{ON} = 40\text{ m}\Omega$ at $V_{IN} = 3.3\text{ V}$
- Fixed Three Different Turn-on Rise Time 10 μ s / 80 μ s / 1 ms
- Low $< 10\text{ }\mu\text{A}$ at $V_{IN} = 3.3\text{ V}$ Quiescent Current
- Internal ON Pin Pull Down
- Output Discharge Function
- ESD Protection above 8000 V HBM and 2000 V CDM
- These Devices are Pb-Free, Halogen Free/BFR Free and are RoHS Compliant

Applications

- PDAs
- Cell Phones
- GPS Devices
- MP3 Players
- Digital Cameras
- Peripheral Ports
- Hot-Swap Supplies
- Notebook Computers

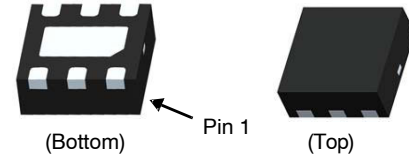

WDFN6 2x2, 0.65P
CASE 511CY

MARKING DIAGRAM

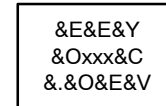

- &E = Designates Space
- &Y = Binary Calendar Year Coding Scheme
- &O = Plant Code identifier
- xxx = Device Specific Code
- &C = Single digit Die Run Code
- &. = Pin One Dot
- &V = Eight-Week Binary Datecoding Scheme

ORDERING INFORMATION

See detailed ordering and shipping information on page 10 of this data sheet.

FPF1007 – FPF1009

Typical Application Circuit

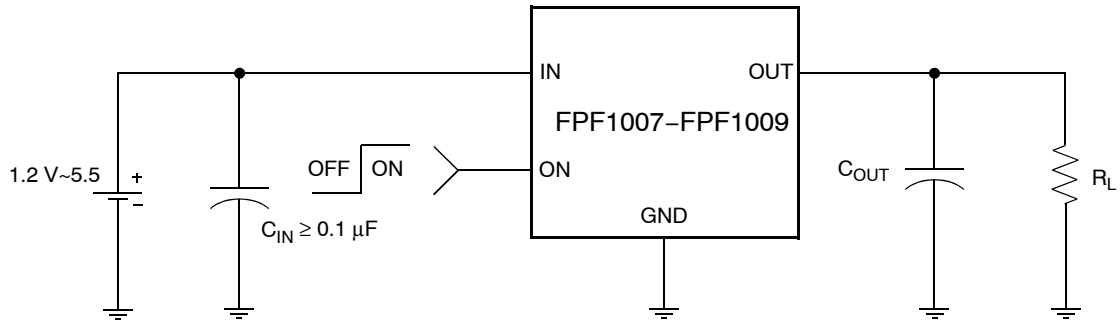

Figure 1. Typical Application Circuit

Functional Block Diagram

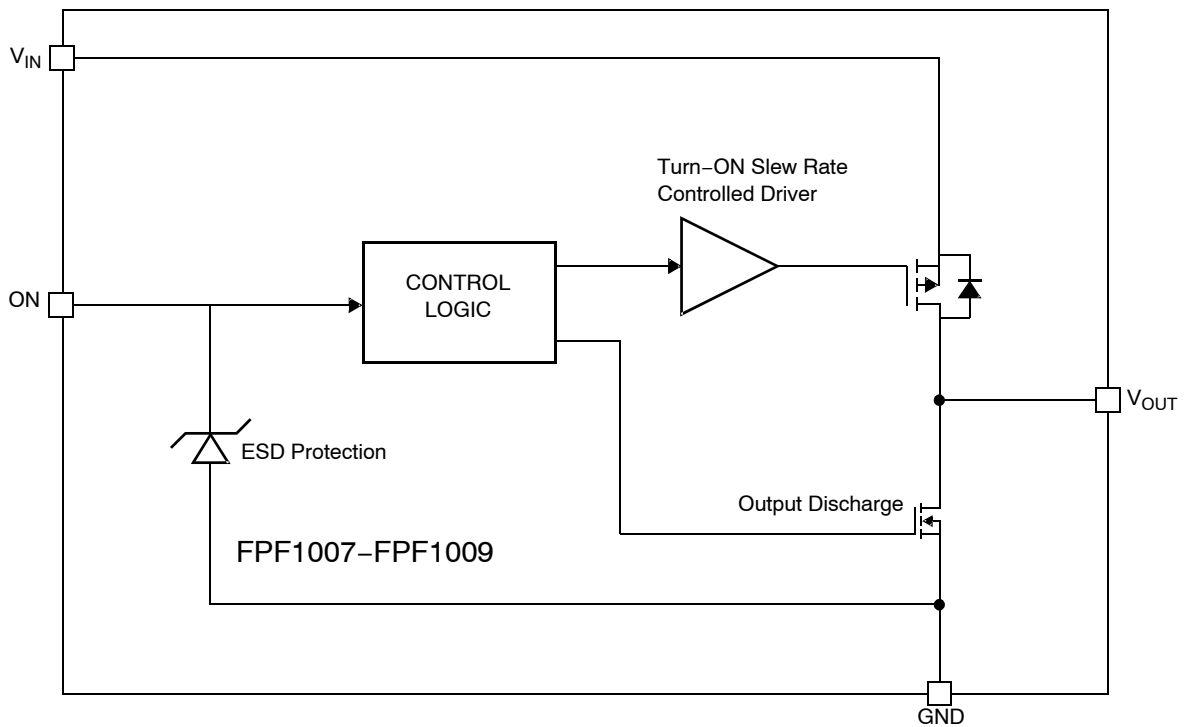

Figure 2. Functional Block Diagram

FPF1007 – FPF1009

Pin Configuration

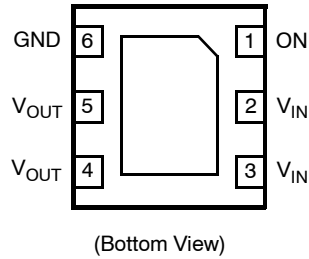

Figure 3. Pin Configuration

PIN DESCRIPTIONS

Name	Type	Description
4, 5	V _{OUT}	Switch Output: Output of the power switch
2, 3	V _{IN}	Supply Input: Input to the power switch and the supply voltage for the IC
6	GND	Ground
1	ON	ON/OFF Control Input

ABSOLUTE MAXIMUM RATINGS

Parameter	Min	Max	Unit
V _{IN} , V _{OUT} , ON to GND	-0.3	6.0	V
Maximum Continuous Switch Current		1.5	A
Power Dissipation at T _A = 25°C (Note 1)		1.2	W
Storage Junction Temperature	-65	150	°C
Operating Temperature Range	-40	85	°C
Thermal Resistance, Junction to Ambient		86	°C/W
Electrostatic Discharge Protection	HBM	8000	V
	CDM	2000	

Stresses exceeding those listed in the Maximum Ratings table may damage the device. If any of these limits are exceeded, device functionality should not be assumed, damage may occur and reliability may be affected.

1. Package power dissipation on 1 square inch pad, 2 oz. copper board.

RECOMMENDED OPERATING RANGE

Symbol	Parameter	Min	Max	Unit
V _{IN}	Input Voltage	1.2	5.5	V
T _A	Ambient Operating Temperature	-40	85	°C

Functional operation above the stresses listed in the Recommended Operating Ranges is not implied. Extended exposure to stresses beyond the Recommended Operating Ranges limits may affect device reliability.

FPF1007 – FPF1009

ELECTRICAL CHARACTERISTICS

$V_{IN} = 1.2$ to 5.5 V, $T_A = -40$ to $+85^\circ\text{C}$ unless otherwise noted. Typical values are at $V_{IN} = 3.3$ V and $T_A = 25^\circ\text{C}$.

Symbol	Parameter	Test Condition	Min	Typ	Max	Unit	
Basic Operation							
V_{IN}	Operating Voltage		1.2		5.5	V	
I_Q	Quiescent Current	$I_{OUT} = 0$ mA $V_{ON} = \text{Enabled}$	$V_{IN} = 3.3$ V	8		μA	
			$V_{IN} = 5.5$ V		15		
$I_{Q(\text{off})}$	Off Supply Current	$V_{ON} = \text{GND}$, $V_{OUT} = \text{OPEN}$			1	μA	
$I_{SD(\text{off})}$	Off Switch Current	$V_{ON} = \text{GND}$, $V_{OUT} = \text{GND}$		0.1	1.0	μA	
R_{ON}	On-Resistance		$V_{IN} = 5.5$ V, $I_{OUT} = 200$ mA, $T_A = 25^\circ\text{C}$		30	40	$\text{m}\Omega$
			$V_{IN} = 3.3$ V, $I_{OUT} = 200$ mA, $T_A = 25^\circ\text{C}$		40	55	
			$V_{IN} = 1.5$ V, $I_{OUT} = 200$ mA, $T_A = 25^\circ\text{C}$		100	130	
			$V_{IN} = 1.2$ V, $I_{OUT} = 200$ mA, $T_A = 25^\circ\text{C}$		175	250	
			$V_{IN} = 3.3$ V, $I_{OUT} = 200$ mA, $T_A = -40^\circ\text{C}$ to $+85^\circ\text{C}$	20		65	
R_{PD}	Output Pull Down Resistance	$V_{IN} = 3.3$ V, $V_{ON} = 0$ V, $T_A = 25^\circ\text{C}$		60		Ω	
V_{IL}	ON Input Logic Low Voltage	$V_{IN} = 1.2$ V to 5.5 V			0.4	V	
V_{IH}	ON Input Logic High Voltage	$V_{IN} = 1.2$ V to 5.5 V	1			V	
	ON Input Leakage (On)	$V_{ON} = V_{IN} = 5.5$ V			10	μA	
	ON Input Leakage (Off)	$V_{ON} = \text{GND}$			1	μA	

Dynamic

FPF1007

t_{ON}	Turn On Time	$V_{IN} = 3.3$ V, $R_L = 500$ Ω , $R_{L_CHIP} = 60$ Ω , $C_{OUT} = 0.1$ μF , $T_A = 25^\circ\text{C}$		12		μs
t_R	Rise Time			10		μs
t_{OFF}	Turn Off Time			40		μs
t_F	Fall Time			15		μs

FPF1008

t_{ON}	Turn On Time	$V_{IN} = 3.3$ V, $R_L = 500$ Ω , $R_{L_CHIP} = 60$ Ω , $C_{OUT} = 0.1$ μF , $T_A = 25^\circ\text{C}$		125		μs
t_R	Rise Time			80		μs
t_{OFF}	Turn Off Time			40		μs
t_F	Fall Time			15		μs

FPF1009

t_{ON}	Turn On Time	$V_{IN} = 3.3$ V, $R_L = 500$ Ω , $R_{L_CHIP} = 60$ Ω , $C_{OUT} = 0.1$ μF , $T_A = 25^\circ\text{C}$		2		ms
t_R	Rise Time			1		ms
t_{OFF}	Turn Off Time			40		μs
t_F	Fall Time			15		μs

Product parametric performance is indicated in the Electrical Characteristics for the listed test conditions, unless otherwise noted. Product performance may not be indicated by the Electrical Characteristics if operated under different conditions.

TYPICAL CHARACTERISTICS

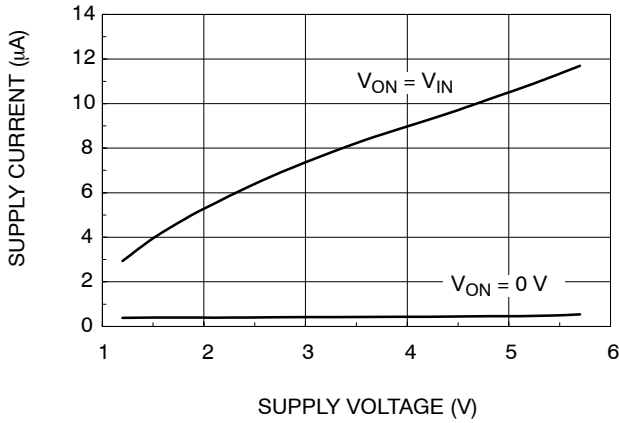

Figure 4. Quiescent Current vs. Input Voltage

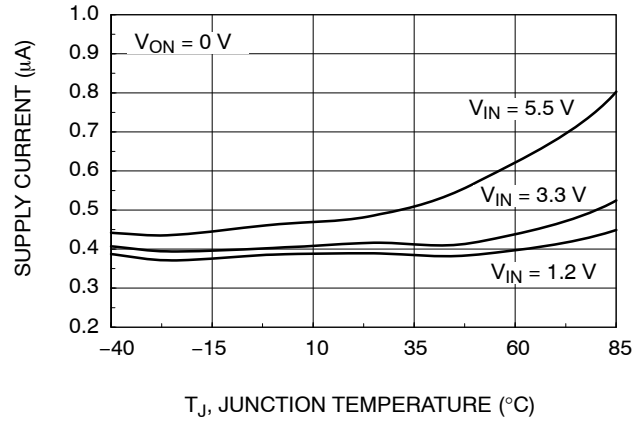

Figure 5. Quiescent Current vs. Temperature

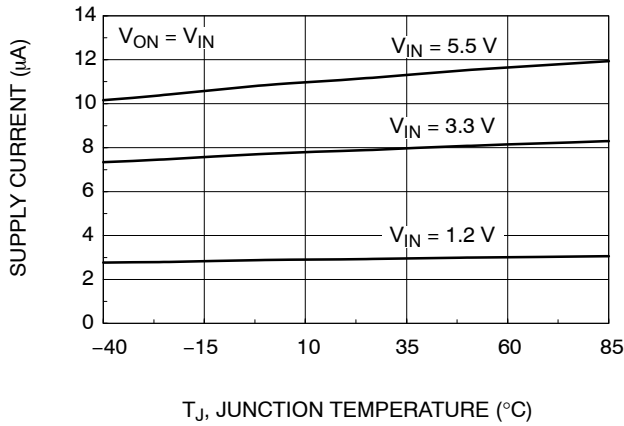

Figure 6. Quiescent Current vs. Temperature

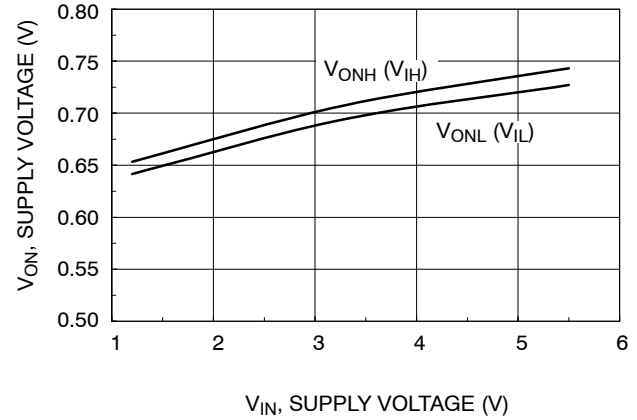

Figure 7. V_{ON} Voltage vs. Input Voltage

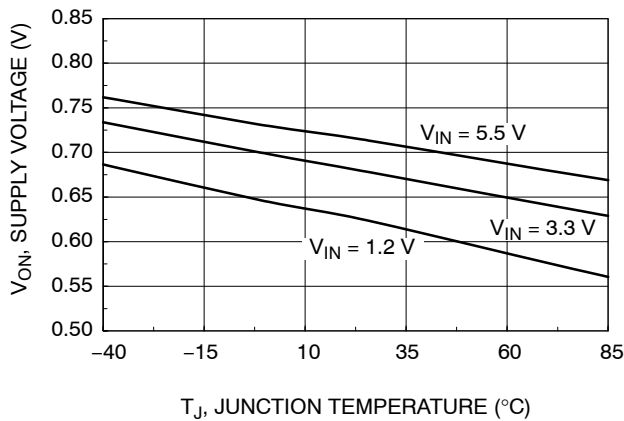

Figure 8. V_{ON} Low Voltage vs. Temperature

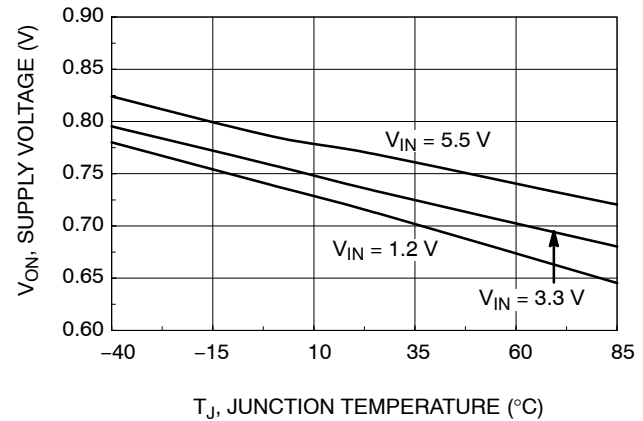

Figure 9. V_{ON} High Voltage vs. Temperature

FPF1007 – FPF1009

TYPICAL CHARACTERISTICS (continued)

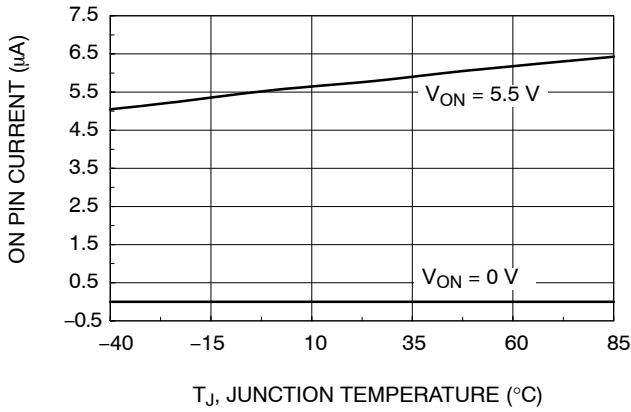

Figure 10. On Pin Current vs. Temperature

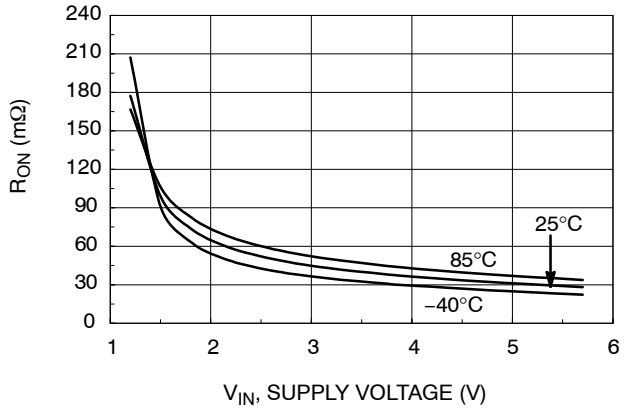

Figure 11. R_{ON} vs. V_{IN}

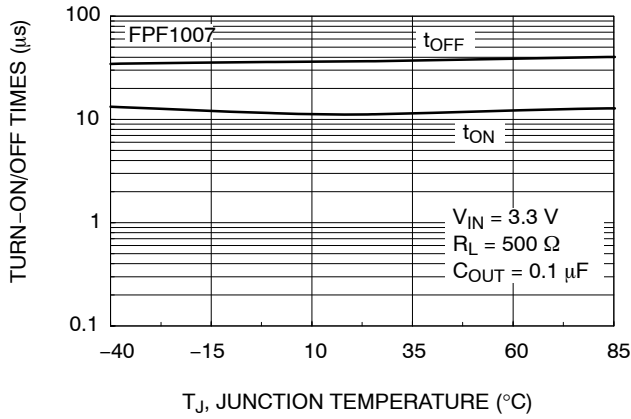

Figure 12. FPF1007 t_{ON} / t_{OFF} vs. Temperature

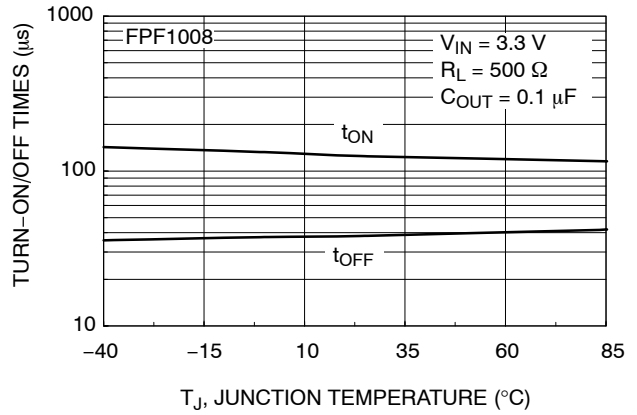

Figure 13. FPF1008 t_{ON} / t_{OFF} vs. Temperature

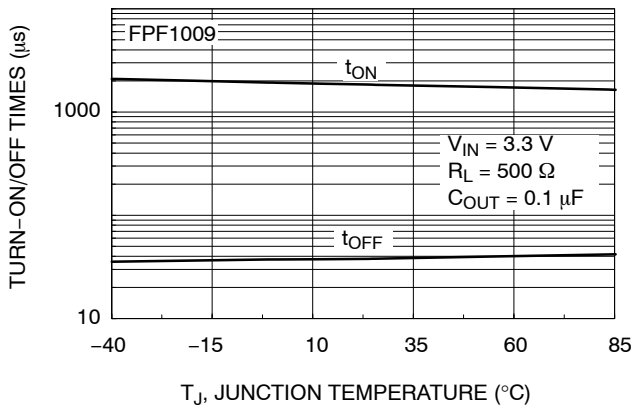

Figure 14. FPF1009 t_{ON} / t_{OFF} vs. Temperature

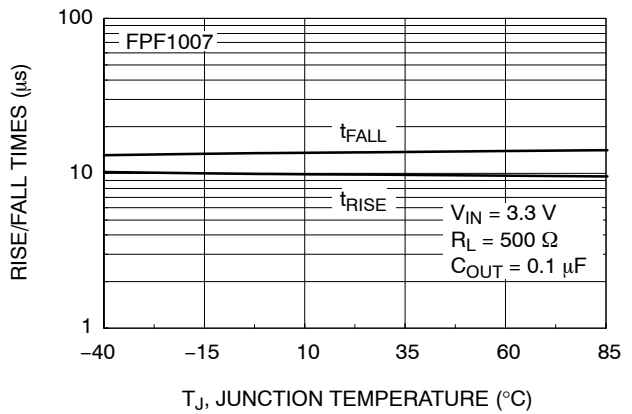

Figure 15. FPF1007 t_{RISE} / t_{FALL} vs. Temperature

FPF1007 – FPF1009

TYPICAL CHARACTERISTICS (continued)

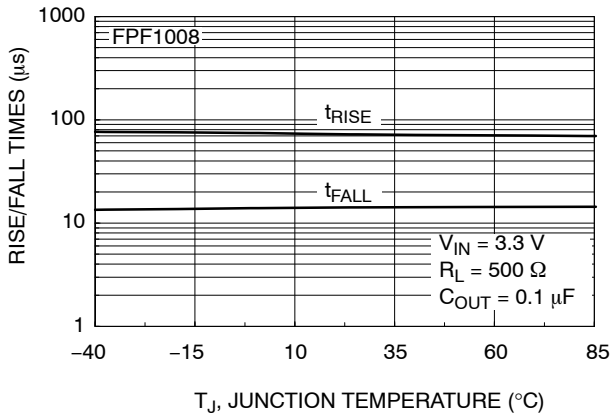

Figure 16. FPF1008 $t_{\text{RISE}} / t_{\text{FALL}}$ vs. Temperature

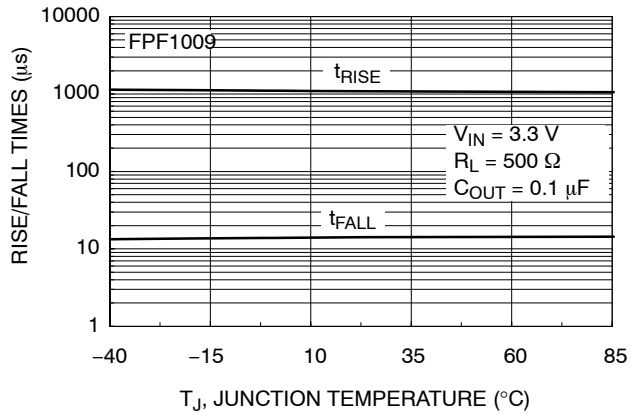

Figure 17. FPF1009 $t_{\text{RISE}} / t_{\text{FALL}}$ vs. Temperature

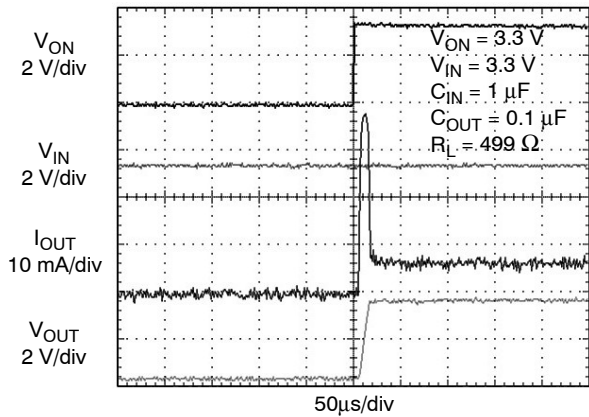

Figure 18. FPF1007 Turn-On Response

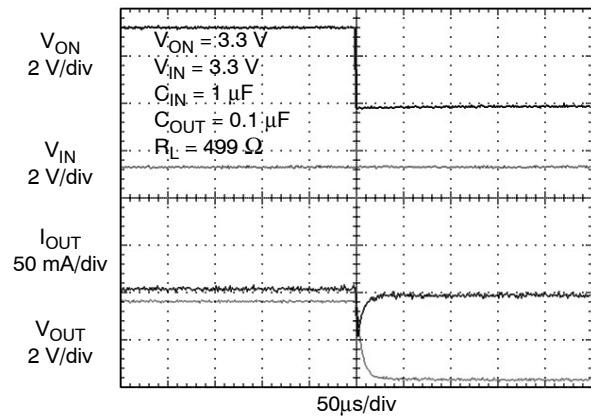

Figure 19. FPF1007 Turn-Off Response

Load current discharged through on-chip output discharge resistor

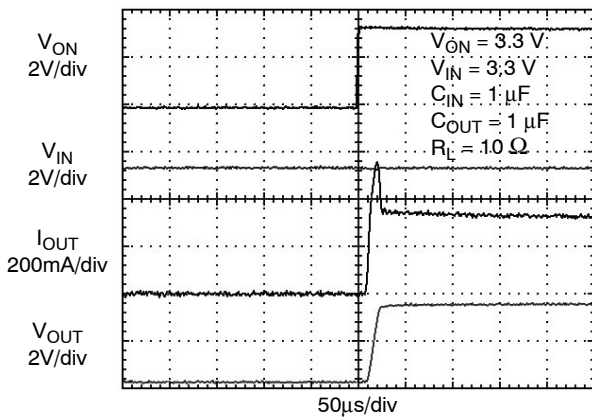

Figure 20. FPF1007 Turn-On Response ($C_{\text{OUT}} = 1 \mu\text{F}$)

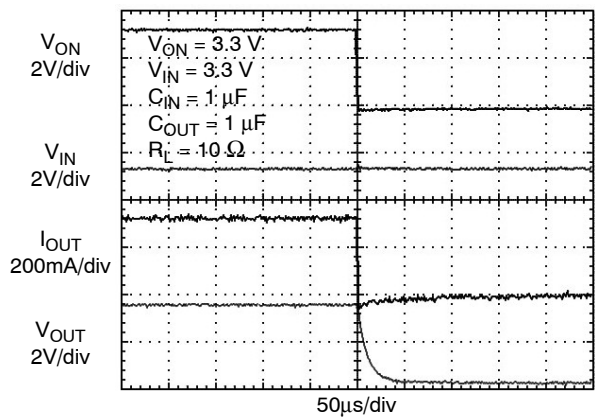

Figure 21. FPF1007 Turn-Off Response

FPF1007 – FPF1009

TYPICAL CHARACTERISTICS (continued)

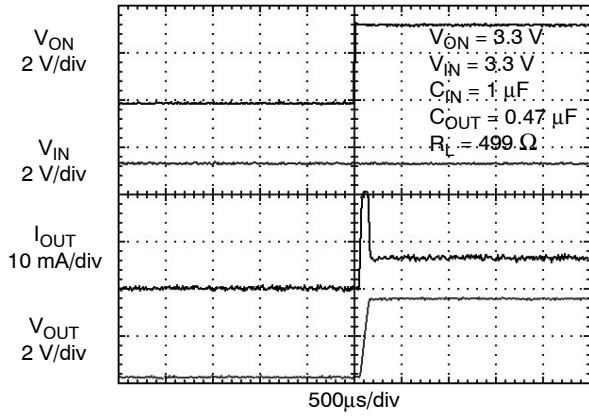

Figure 22. FPF1008 Turn-On Response

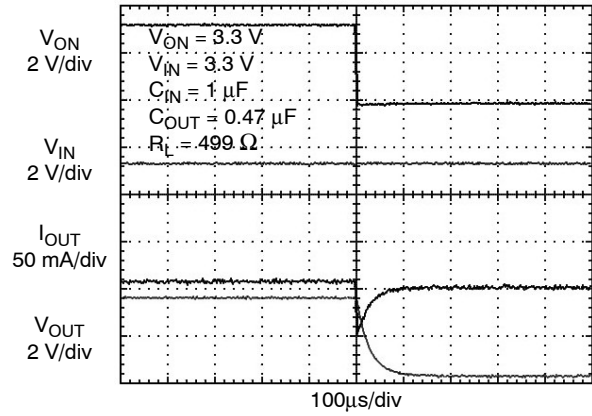

Figure 23. FPF1008 Turn-Off Response

Load current discharged through on-chip output discharge resistor

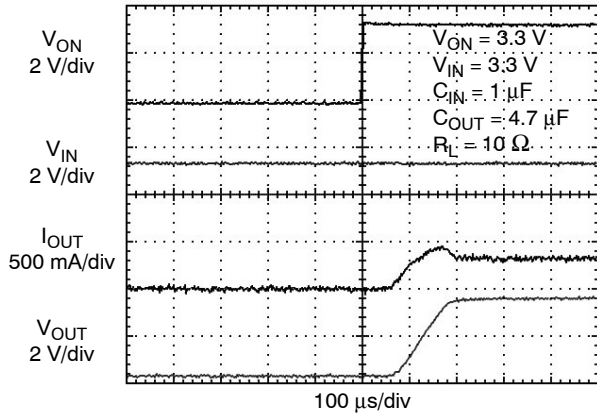

Figure 24. FPF1008 Turn-On Response
($C_{OUT} = 4.7\text{ }\mu\text{F}$)

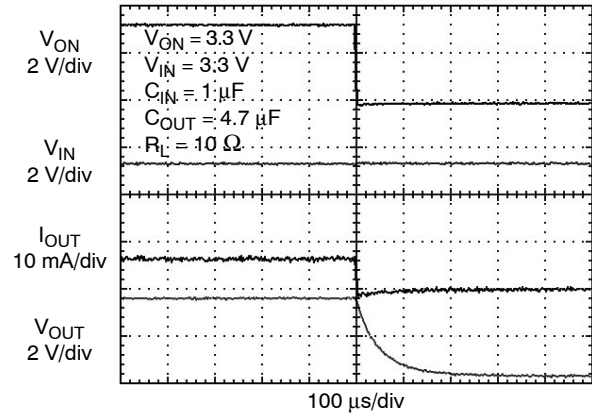

Figure 25. FPF1008 Turn-Off Response

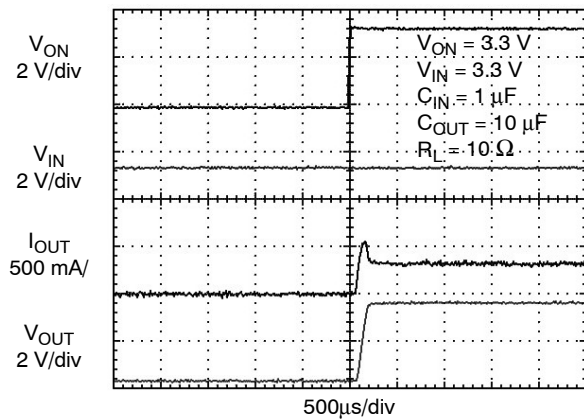

Figure 26. FPF1008 Turn-On Response
($C_{OUT} = 10\text{ }\mu\text{F}$)

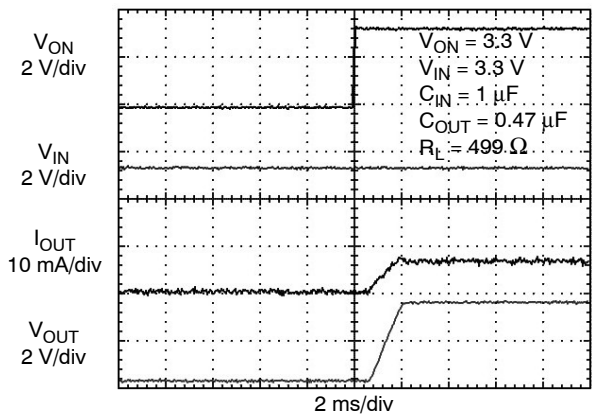

Figure 27. FPF1009 Turn-On Response

FPF1007 – FPF1009

TYPICAL CHARACTERISTICS (continued)

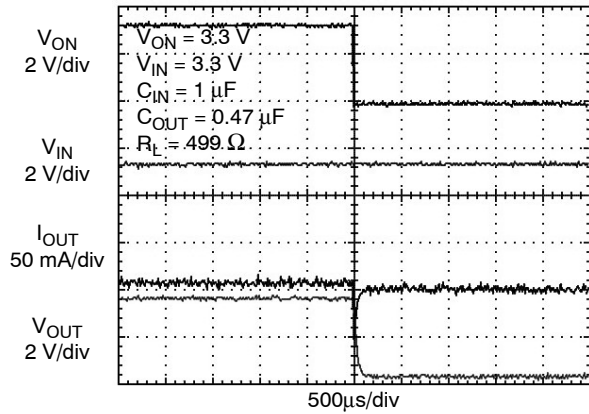

Figure 28. FPF1009 Turn-Off Response

Load current discharged through on-chip output discharge resistor

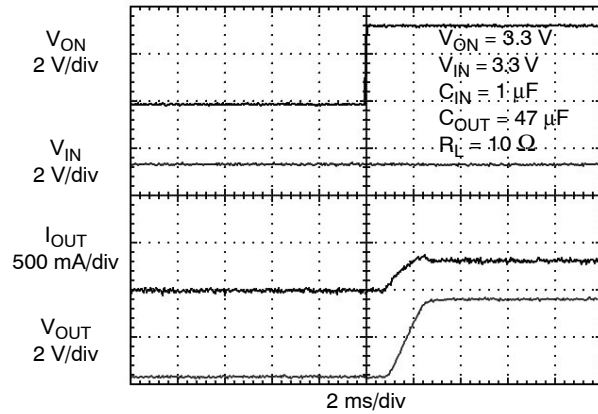

Figure 29. FPF1009 Turn-On Response
($C_{OUT} = 47\ \mu\text{F}$)

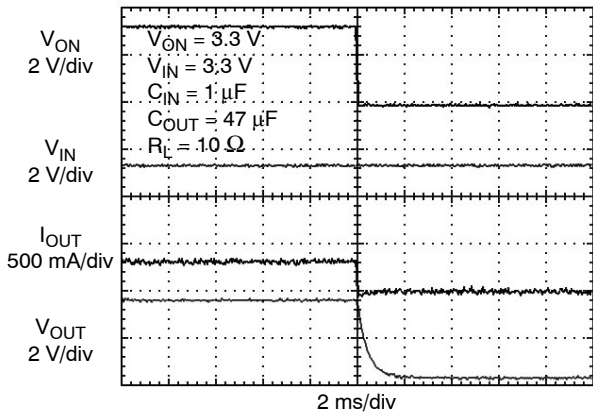

Figure 30. FPF1009 Turn-Off Response

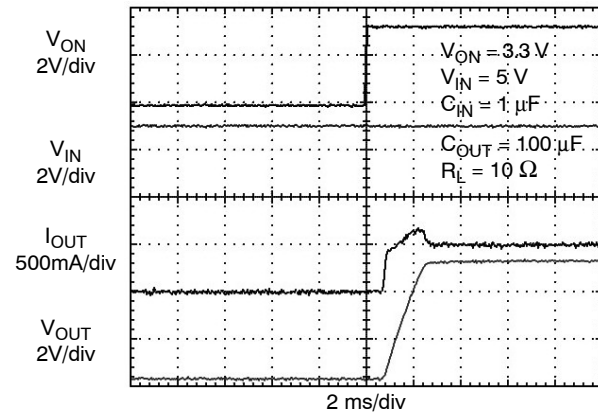
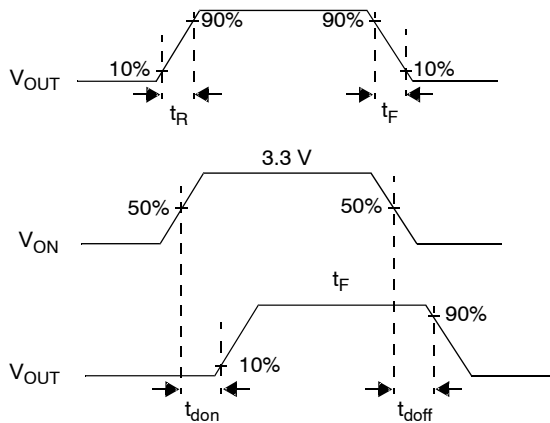

Figure 31. FPF1009 Turn-On Response
($C_{OUT} = 100\ \mu\text{F}$, $V_{IN} = 5\text{ V}$)

Timing Diagram



where:

- t_{ON} = Turn-On Time
- t_{OFF} = Turn-Off Time
- t_{don} = Turn-On Delay Time
- t_{doff} = Turn-Off Delay Time
- t_R = Rise Time
- t_F = V_{OUT} Fall Time
- $t_{ON} = t_R + t_{don}$
- $t_{OFF} = t_F + t_{doff}$

Figure 32. Timing Diagram

FPF1007 – FPF1009

ORDERING INFORMATION

Part Number	Switch R _{ON} at 5.5 V (Typ.)	Rise Time (Typ.)	Output Discharge (Typ.)	ON Pin Activity	Top Mark	Shipping [†]
FPF1007	30 mΩ, PMOS	10 μs	60 Ω	Active HIGH	007	3000 / Tape & Reel
FPF1008	30 mΩ, PMOS	80 μs	60 Ω	Active HIGH	008	3000 / Tape & Reel
FPF1009	30 mΩ, PMOS	1 ms	60 Ω	Active HIGH	009	3000 / Tape & Reel

[†]For information on tape and reel specifications, including part orientation and tape sizes, please refer to our Tape and Reel Packaging Specifications Brochure, BRD8011/D

IntelliMAX is a trademark of Semiconductor Components Industries, LLC dba "onsemi" or its affiliates and/or subsidiaries in the United States and/or other countries.

MECHANICAL CASE OUTLINE

PACKAGE DIMENSIONS

ON Semiconductor®



WDFN6 2x2, 0.65P
CASE 511CY
ISSUE O

DATE 31 JUL 2016

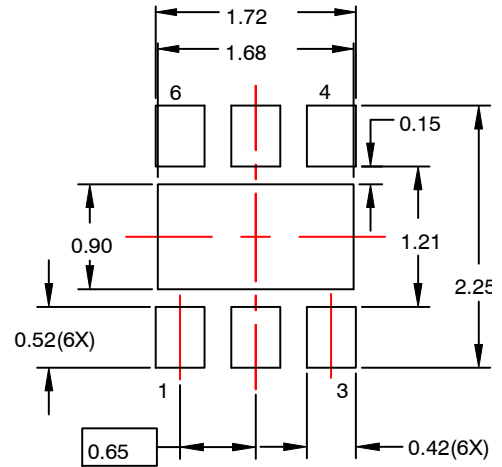
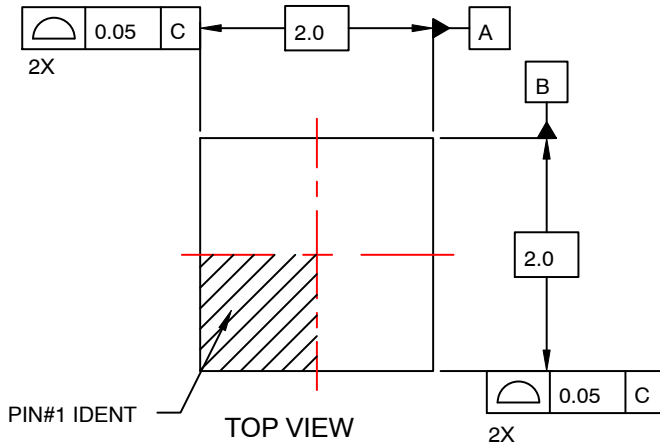

RECOMMENDED LAND PATTERN

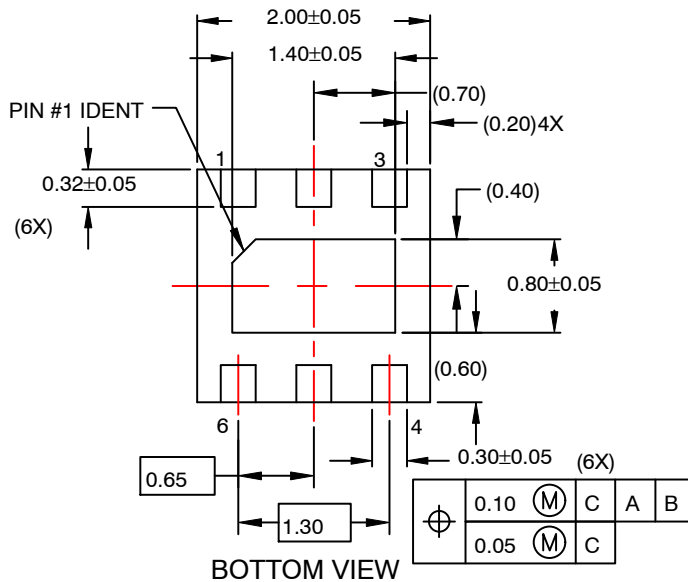
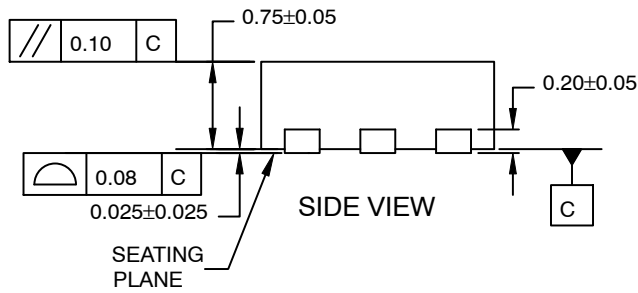

NOTES:

- A. PACKAGE DOES NOT FULLY CONFORM TO JEDEC MO-229 REGISTRATION
- B. DIMENSIONS ARE IN MILLIMETERS.
- C. DIMENSIONS AND TOLERANCES PER ASME Y14.5M, 2009.
- D. LAND PATTERN RECOMMENDATION IS EXISTING INDUSTRY LAND PATTERN.

DOCUMENT NUMBER:	98AON13613G	Electronic versions are uncontrolled except when accessed directly from the Document Repository. Printed versions are uncontrolled except when stamped "CONTROLLED COPY" in red.
DESCRIPTION:	WDFN6 2X2, 0.65P	PAGE 1 OF 1

ON Semiconductor and are trademarks of Semiconductor Components Industries, LLC dba ON Semiconductor or its subsidiaries in the United States and/or other countries. ON Semiconductor reserves the right to make changes without further notice to any products herein. ON Semiconductor makes no warranty, representation or guarantee regarding the suitability of its products for any particular purpose, nor does ON Semiconductor assume any liability arising out of the application or use of any product or circuit, and specifically disclaims any and all liability, including without limitation special, consequential or incidental damages. ON Semiconductor does not convey any license under its patent rights nor the rights of others.

onsemi, **Onsemi**, and other names, marks, and brands are registered and/or common law trademarks of Semiconductor Components Industries, LLC dba "**onsemi**" or its affiliates and/or subsidiaries in the United States and/or other countries. **onsemi** owns the rights to a number of patents, trademarks, copyrights, trade secrets, and other intellectual property. A listing of **onsemi**'s product/patent coverage may be accessed at www.onsemi.com/site/pdf/Patent-Marking.pdf. **onsemi** reserves the right to make changes at any time to any products or information herein, without notice. The information herein is provided "as-is" and **onsemi** makes no warranty, representation or guarantee regarding the accuracy of the information, product features, availability, functionality, or suitability of its products for any particular purpose, nor does **onsemi** assume any liability arising out of the application or use of any product or circuit, and specifically disclaims any and all liability, including without limitation special, consequential or incidental damages. Buyer is responsible for its products and applications using **onsemi** products, including compliance with all laws, regulations and safety requirements or standards, regardless of any support or applications information provided by **onsemi**. "Typical" parameters which may be provided in **onsemi** data sheets and/or specifications can and do vary in different applications and actual performance may vary over time. All operating parameters, including "Typicals" must be validated for each customer application by customer's technical experts. **onsemi** does not convey any license under any of its intellectual property rights nor the rights of others. **onsemi** products are not designed, intended, or authorized for use as a critical component in life support systems or any FDA Class 3 medical devices or medical devices with a same or similar classification in a foreign jurisdiction or any devices intended for implantation in the human body. Should Buyer purchase or use **onsemi** products for any such unintended or unauthorized application, Buyer shall indemnify and hold **onsemi** and its officers, employees, subsidiaries, affiliates, and distributors harmless against all claims, costs, damages, and expenses, and reasonable attorney fees arising out of, directly or indirectly, any claim of personal injury or death associated with such unintended or unauthorized use, even if such claim alleges that **onsemi** was negligent regarding the design or manufacture of the part. **onsemi** is an Equal Opportunity/Affirmative Action Employer. This literature is subject to all applicable copyright laws and is not for resale in any manner.

PUBLICATION ORDERING INFORMATION

LITERATURE FULFILLMENT:

Email Requests to: orderlit@onsemi.com

onsemi Website: www.onsemi.com

TECHNICAL SUPPORT

North American Technical Support:

Voice Mail: 1 800-282-9855 Toll Free USA/Canada

Phone: 011 421 33 790 2910

Europe, Middle East and Africa Technical Support:

Phone: 00421 33 790 2910

For additional information, please contact your local Sales Representative