



MMIC SURFACE MOUNT

Power Splitter/Combiner

GP2Y+

2 Way-0° 50Ω 1600 to 3300 MHz

FEATURES

- Wide bandwidth, 1600 to 3300 MHz
- Excellent isolation, 24 dB typ.
- Excellent amplitude unbalance, 0.02 dB typ.
- Good phase unbalance, 0.3 deg. typ.
- Small size, 0.118"x0.118"x0.035"
- High ESD level
- Aqueous washable

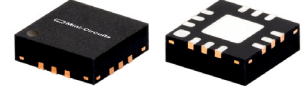

Generic photo used for illustration purposes only

CASE STYLE: DQ1225

+RoHS Compliant

The +Suffix identifies RoHS Compliance. See our website for methodologies and qualifications

APPLICATIONS

- WCDMA
- DCS
- Radar
- Navigation
- Instrumentation
- Korea PCS
- WiMax

ELECTRICAL SPECIFICATIONS AT 25°C

| Parameter | Frequency (MHz) | Min. | Typ. | Max. | Units |
|--------------------------------|-----------------|------|------|------|-------|
| Frequency Range | | 1600 | | 3300 | MHz |
| Insertion Loss* (above 3.0 dB) | 1600-3300 | — | 0.8 | 1.5 | dB |
| Isolation | 1600-3300 | 17 | 24 | — | dB |
| Amplitude Unbalance | 1600-3300 | — | — | 0.2 | dB |
| Phase Unbalance | 1600-3300 | — | — | 4.0 | deg. |
| VSWR (Port S) | 1600-3300 | — | 1.2 | — | :1 |
| VSWR (Ports 1,2) | 1600-3300 | — | 1.2 | — | |

* De-embedded from demo board loss.

MAXIMUM RATINGS

| Parameter | Ratings |
|-----------------------------|----------------|
| Operating temperature | -40°C to 85°C |
| Storage temperature | -65°C to 150°C |
| Power Input (as a splitter) | 1.5W max. |
| Internal Dissipation | 0.75W max. |

Permanent damage may occur if any of these limits are exceeded.

ELECTRICAL SCHEMATIC



REV. D
ECO-015315
GP2Y+
MCL NY
220912





MMIC SURFACE MOUNT

Power Splitter/Combiner

GP2Y+

Mini-Circuits

2 Way-0° 50Ω 1600 to 3300 MHz

PAD CONNECTIONS

| | |
|----------|------------------------------|
| SUM PORT | 2 |
| PORT 1 | 7 |
| PORT 2 | 9 |
| GROUND | 1,3,4,5,6,8,10,11,12, paddle |

DEMO BOARD MCL P/N: TB-453-GP2Y+
SUGGESTED PCB LAYOUT (PL-282)

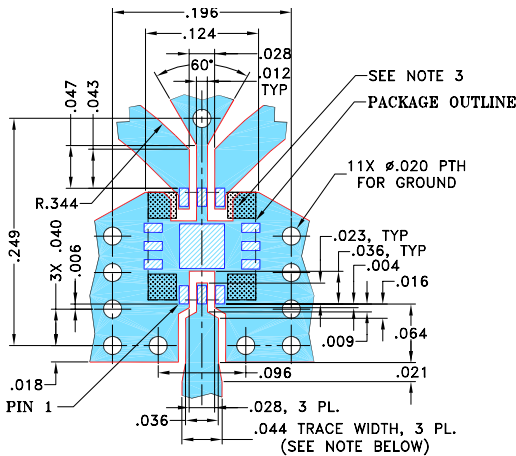

NOTES:

1. TRACE WIDTH IS SHOWN FOR ROGERS RO4350B WITH DIELECTRIC THICKNESS .020" ± .0015"; COPPER: 1/2 OZ. EACH SIDE. FOR OTHER MATERIALS TRACE WIDTH AND GAP MAY NEED TO BE MODIFIED.
2. BOTTOM SIDE OF THE PCB IS CONTINUOUS GROUND PLANE.
3. SIGNAL TRACES ARE NOT ALLOWED INSIDE HATCHED AREAS (APPROX. .030 X .030) AT 4 PLACES AS SHOWN.

- DENOTES PCB COPPER LAYOUT WITH SMOBC (SOLDER MASK OVER BARE COPPER)
- DENOTES COPPER LAND PATTERN FREE OF SOLDER MASK

OUTLINE DRAWING

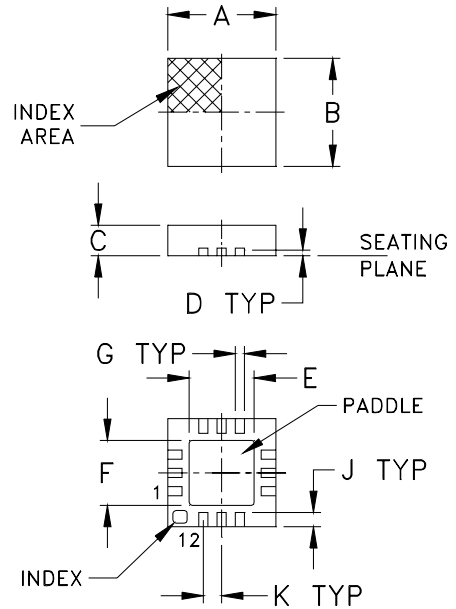

PCB Land Pattern

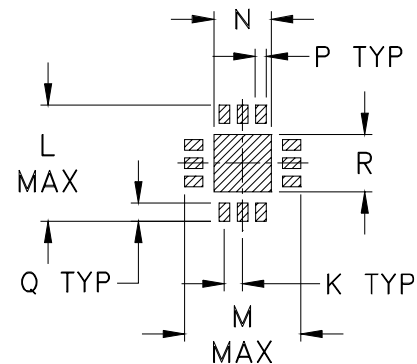

Suggested Layout,
Tolerance to be within ±.002

PRODUCT MARKING

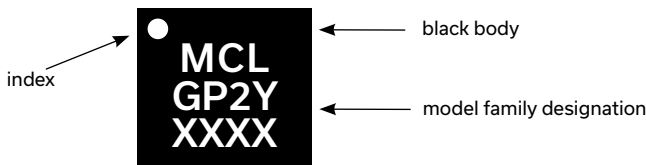

Marking may contain other features or characters for internal lot control

OUTLINE DIMENSIONS (Inch/mm)

| | | | | | | | | |
|------|------|------|------|------|------|------|-----|-------|
| A | B | C | D | E | F | G | H | J |
| .118 | .118 | .035 | .008 | .057 | .057 | .009 | --- | .016 |
| 3.00 | 3.00 | 0.89 | 0.20 | 1.45 | 1.45 | 0.23 | --- | 0.41 |
| K | L | M | N | P | Q | R | | wt |
| .020 | .127 | .127 | .049 | .010 | .020 | .049 | | grams |
| 0.51 | 3.23 | 3.23 | 1.24 | 0.25 | 0.51 | 1.24 | | 0.02 |

TAPE & REEL INFORMATION: F66



TYPICAL PERFORMANCE DATA AND CHARTS

| Frequency (MHz) | Total Loss ¹ (dB) | | Amplitude Unbalance (dB) | Isolation (dB) | Phase Unbalance (deg.) | VSWR S | VSWR 1 | VSWR 2 |
|-----------------|------------------------------|------|--------------------------|----------------|------------------------|--------|--------|--------|
| | S-1 | S-2 | | | | | | |
| 1600.00 | 3.99 | 3.98 | 0.01 | 26.03 | 0.38 | 1.26 | 1.19 | 1.21 |
| 1780.00 | 3.77 | 3.77 | 0.00 | 28.31 | 0.44 | 1.07 | 1.13 | 1.14 |
| 1870.00 | 3.74 | 3.74 | 0.00 | 24.68 | 0.47 | 1.16 | 1.14 | 1.15 |
| 1960.00 | 3.72 | 3.73 | 0.01 | 22.92 | 0.47 | 1.24 | 1.15 | 1.16 |
| 2140.00 | 3.70 | 3.72 | 0.02 | 21.93 | 0.54 | 1.31 | 1.17 | 1.19 |
| 2230.00 | 3.69 | 3.71 | 0.02 | 22.14 | 0.58 | 1.32 | 1.17 | 1.19 |
| 2320.00 | 3.67 | 3.69 | 0.02 | 22.75 | 0.57 | 1.30 | 1.16 | 1.17 |
| 2490.00 | 3.64 | 3.66 | 0.02 | 24.97 | 0.59 | 1.23 | 1.12 | 1.15 |
| 2580.00 | 3.63 | 3.64 | 0.01 | 26.91 | 0.55 | 1.18 | 1.10 | 1.12 |
| 2760.00 | 3.62 | 3.63 | 0.01 | 33.79 | 0.51 | 1.08 | 1.07 | 1.09 |
| 2940.00 | 3.64 | 3.65 | 0.00 | 33.00 | 0.45 | 1.10 | 1.09 | 1.08 |
| 3030.00 | 3.67 | 3.67 | 0.00 | 28.80 | 0.45 | 1.15 | 1.13 | 1.12 |
| 3120.00 | 3.70 | 3.70 | 0.00 | 25.78 | 0.45 | 1.21 | 1.17 | 1.15 |
| 3210.00 | 3.73 | 3.73 | 0.00 | 23.47 | 0.46 | 1.29 | 1.20 | 1.19 |
| 3300.00 | 3.77 | 3.78 | 0.01 | 21.67 | 0.49 | 1.36 | 1.24 | 1.24 |

1. Total Loss = Insertion Loss + 3dB splitter loss.

GP2X+
TOTAL LOSS

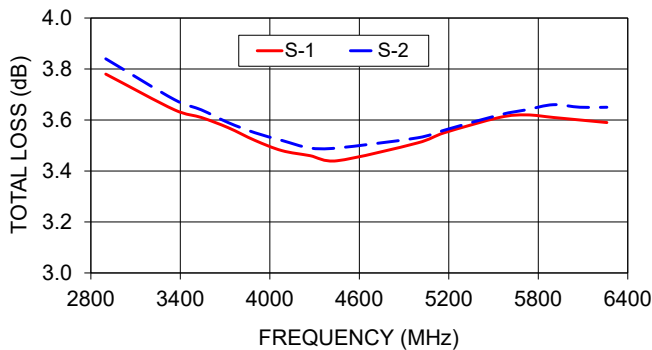

GP2X+
ISOLATION

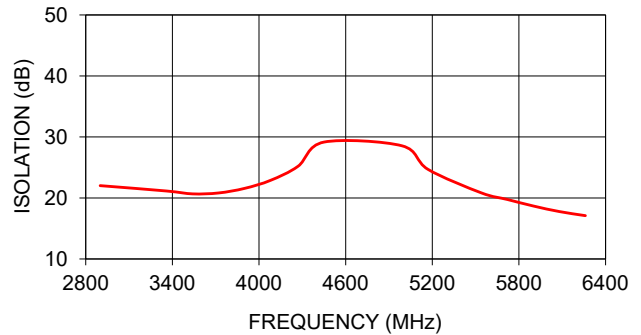

GP2X+
VSWR

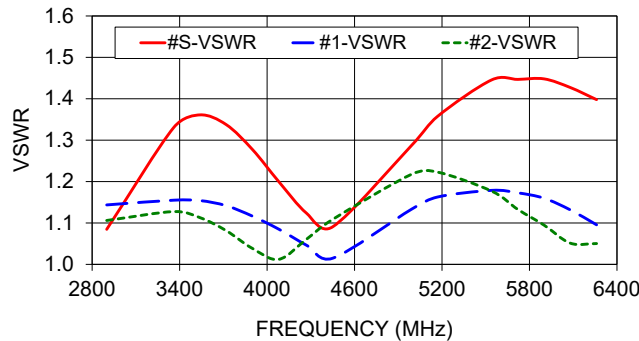

ESD RATING

Human Body Model (HBM): Class 1A (250 to < 500V) in accordance with ANSI/ESD STM 5.1 - 2001

Machine Model (MM): Class M2 (100V to < 250V) in accordance with ANSI/ESD STM 5.2 - 1999

NOTES

- A. Performance and quality attributes and conditions not expressly stated in this specification document are intended to be excluded and do not form a part of this specification document.
- B. Electrical specifications and performance data contained in this specification document are based on Mini-Circuit's applicable established test performance criteria and measurement instructions.
- C. The parts covered by this specification document are subject to Mini-Circuits standard limited warranty and terms and conditions (collectively, "Standard Terms"); Purchasers of this part are entitled to the rights and benefits contained therein. For a full statement of the standard terms and the exclusive rights and remedies thereunder, please visit Mini-Circuits' website at www.minicircuits.com/terms/viewterm.html

