



Wireless Power Transfer

Rx (receiving) coil units

WR483245-15F5-G

Wireless Power Transfer

Product compatible with RoHS directive
Halogen-free

Rx (receiving) coil units

Overview of WR483245-15F5-G

FEATURES

- Receiving coils for Wireless Power Transfer.
- Pre cracked ferrite is available for durable construction.
- Variety of thickness : from 0.50mm to 1.12mm.
- Flexible sheet type is available.
- Custom design is available based on each design requirements.

APPLICATION

Smartphones, cellular phones, handheld mobile terminals, and DSCs

SHAPE & DIMENSIONS

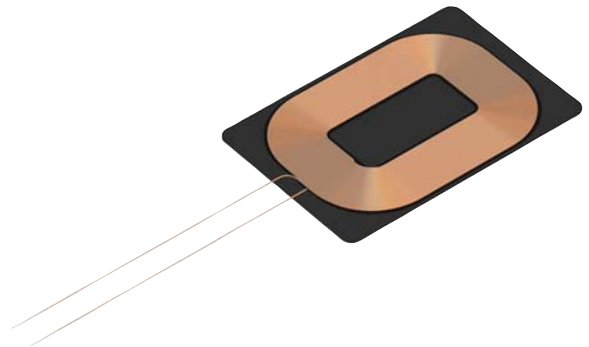
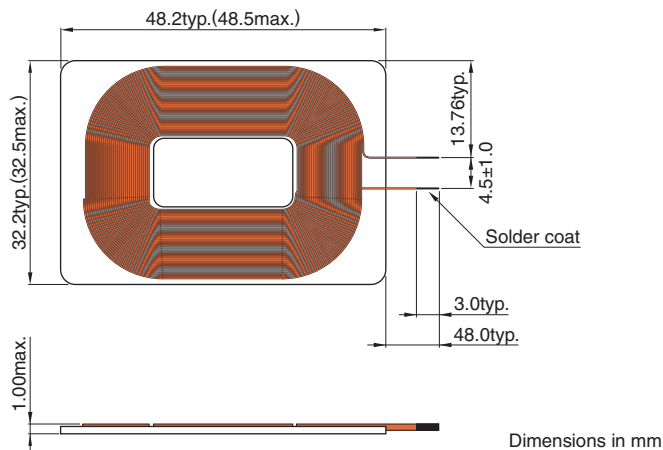

ELECTRICAL CHARACTERISTICS

CHARACTERISTICS SPECIFICATION TABLES

L x W dimensions (mm)	Thickness (mm)max.	Efficiency* (%)ref.	Inductance [100kHz, 1Vrms] (μH)	DC resistance [25°C] (Ω)max.	Part No.
48.2x32.2	1.00	72	13.0	0.20	WR483245-15F5-G

* Contact us for more information.

IC REFERENCE INFORMATION

IC	Manufacturer material name	Web
Please contact us.		

- RoHS Directive Compliant Product: See the following for more details. <https://product.tdk.com/info/en/environment/rohs/index.html>
- Halogen-free: Indicates that Cl content is less than 900ppm, Br content is less than 900ppm, and that the total Cl and Br content is less than 1500ppm.

⚠ Please be sure to request delivery specifications that provide further details on the features and specifications of the products for proper and safe use.
Please note that the contents may change without any prior notice due to reasons such as upgrading.

⚠ Reminders

- Do not use or store in locations where there are conditions such as gas corrosion (salt, acid, alkali, etc.).
- Self heating (temperature increase) occurs when the power is turned ON, so the tolerance should be sufficient for the set thermal design.
- Fully caution, if metal piece contacted with top of coil surface then it could be danger of generated heat.
- Do not use for a purpose outside of the contents regulated in the delivery specifications.
- The products listed on this catalog are intended for use in general electronic equipment (AV equipment, telecommunications equipment, home appliances, amusement equipment, computer equipment, personal equipment, office equipment, measurement equipment, industrial robots) under a normal operation and use condition.

The products are not designed or warranted to meet the requirements of the applications listed below, whose performance and/or quality require a more stringent level of safety or reliability, or whose failure, malfunction or trouble could cause serious damage to society, person or property.

If you intend to use the products in the applications listed below or if you have special requirements exceeding the range or conditions set forth in the each catalog, please contact us.

- | | |
|---|--|
| (1) Aerospace/aviation equipment | (8) Public information-processing equipment |
| (2) Transportation equipment (cars, electric trains, ships, etc.) | (9) Military equipment |
| (3) Medical equipment | (10) Electric heating apparatus, burning equipment |
| (4) Power-generation control equipment | (11) Disaster prevention/crime prevention equipment |
| (5) Atomic energy-related equipment | (12) Safety equipment |
| (6) Seabed equipment | (13) Other applications that are not considered general-purpose applications |
| (7) Transportation control equipment | |