

## High Efficiency 2-Channel WLED Driver with PWM Control

### Features

- High Efficiency (No Switching Losses)
- PWM Frequency as Low as 250 Hz
- Input Voltage Range: 3.0V to 5.5V
- Linear Driver Dropout of 52 mV at 30.2 mA
- Matching Better than  $\pm 0.5\%$  (Typical)
- Current Accuracy Better than 1.0% (Typical)
- Available in Thin SOT-23 and SC-70 Packages

### Applications

- Mobile Handsets
- Digital Cameras
- Portable Media/MP3 Players
- Portable Navigation Devices (GPS)
- Portable Applications

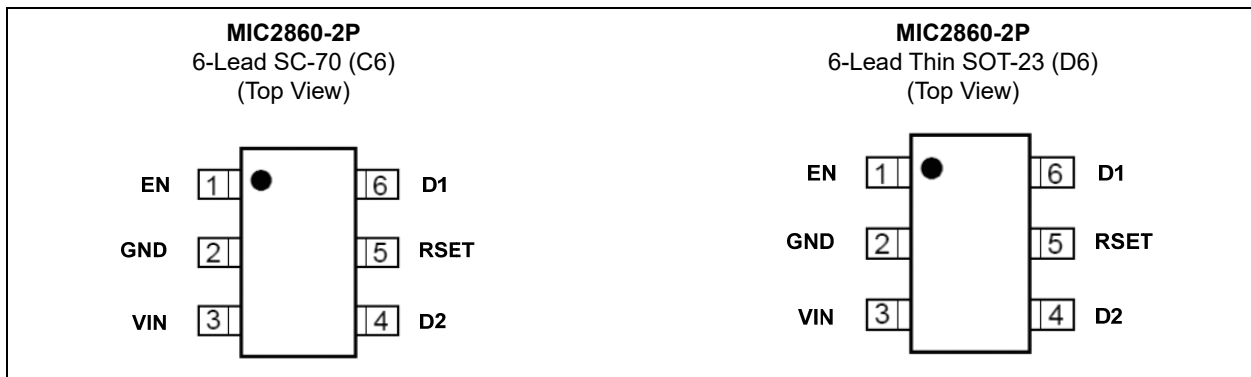
### General Description

The MIC2860-2P is a high efficiency white LED (WLED) driver designed to drive two WLEDs and greatly extend battery life for portable display backlighting and keypad backlighting in low-cost mobile devices. The MIC2860-2P architecture provides the highest possible efficiency by eliminating switching losses present in traditional charge pumps or inductive boost circuits. It features a typical dropout of 52 mV at 30.2 mA per channel. This allows the WLEDs to be driven directly from the battery, eliminating switching noise and losses present with the use of boost circuitry.

The two channels have typical matching of  $\leq \pm 0.5\%$ , which ensures uniform display illumination under all conditions. The WLED's brightness is externally preset by a resistor and dimmed using PWM interface operating down to less than 1% duty cycle.

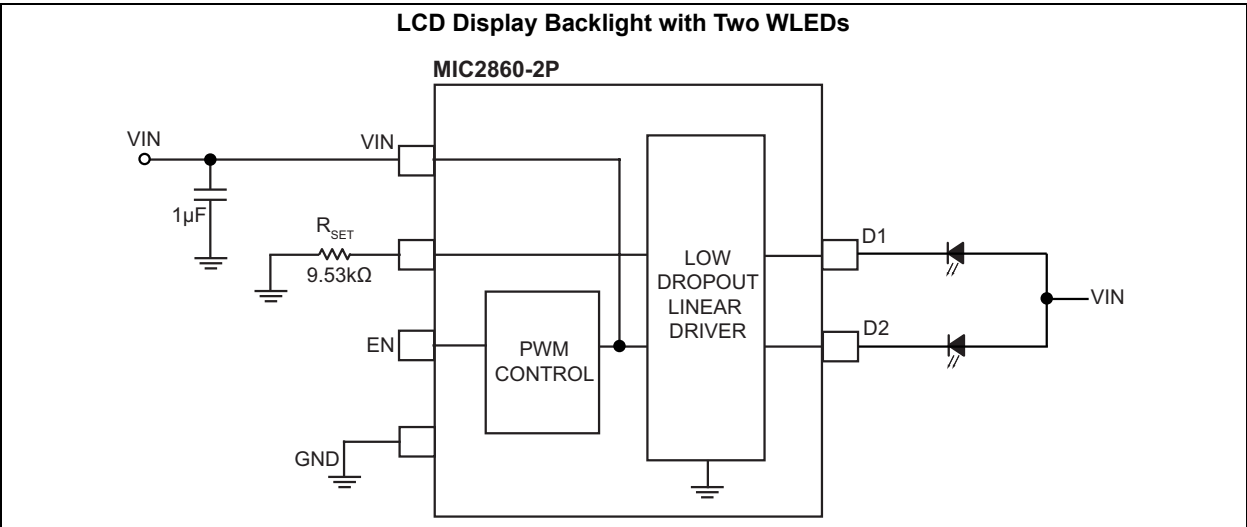
The MIC2860-2P is available in Thin SOT-23 and SC-70 6-lead packages with a junction temperature range of  $-40^{\circ}\text{C}$  to  $+125^{\circ}\text{C}$ .

### Package Types

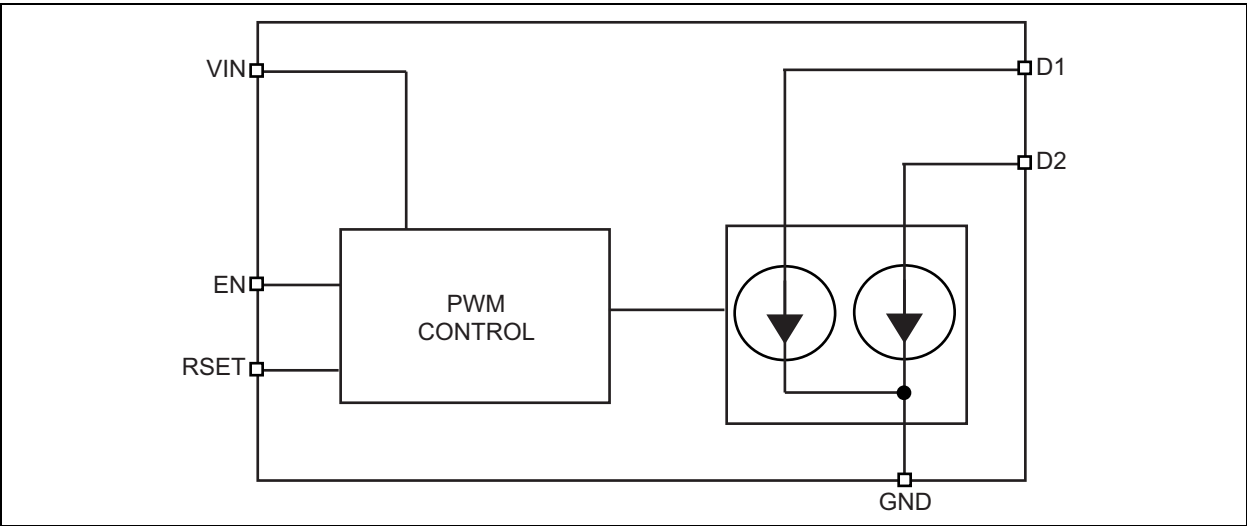


# MIC2860-2P

## Typical Application Circuit



## Functional Block Diagram



## 1.0 ELECTRICAL CHARACTERISTICS

### Absolute Maximum Ratings †

Main Input Voltage ( $V_{IN}$ ).....	-0.3V to +6V
Enable Input Voltage ( $V_{EN}$ ).....	-0.3V to $V_{IN}$
LED Driver Voltage ( $V_{D1, D2}$ ).....	-0.3V to $V_{IN}$
Power Dissipation .....	Internally Limited
ESD Rating .....	2 kV

### Operating Ratings ‡

Supply Voltage ( $V_{IN}$ ) .....	+3.0 to +5.5V
Enable Input Voltage ( $V_{EN}$ ).....	.0V to $V_{IN}$
LED Driver Voltage ( $V_{D1, D2}$ ).....	.0V to $V_{IN}$

† **Notice:** Stresses above those listed under “Absolute Maximum Ratings” may cause permanent damage to the device. This is a stress rating only and functional operation of the device at those or any other conditions above those indicated in the operational sections of this specification is not intended. Exposure to maximum rating conditions for extended periods may affect device reliability.

‡ **Notice:** The device is not guaranteed to function outside its operating ratings.

## ELECTRICAL CHARACTERISTICS

**Electrical Characteristics:**  $V_{IN} = V_{EN} = 3.6V$ ,  $C_{IN} = 1 \mu F$ ,  $R_{SET} = 9.53 k\Omega$ ;  $V_{D1, D2} = 0.6V$ ;  $T_J = +25^\circ C$ , **bold** values valid for  $-40^\circ C \leq T_J \leq +85^\circ C$ ; unless noted.

Parameter	Symbol	Min.	Typ.	Max.	Units	Conditions
Current Accuracy		<b>27.18</b>	30.2	<b>33.22</b>	mA	Note 1
Matching		—	$\pm 0.5$	$\pm 3$	%	Note 2
Dropout ( $V_{D1, D2}$ )	$V_{DROP}$	—	52	<b>125</b>	mV	Where $I_{LED} = 90\%$ of LED current seen at $V_{DROPNOM} = 0.6V$ , 100% brightness level
Ground/Supply Bias Current	$I_{GND}$	—	0.7	<b>1.5</b>	mA	$I_{OUT} = 30.2$ mA
Shutdown Current	$I_{SHDN}$	—	0.01	1	$\mu A$	Current source leakage, $V_{EN} = 0V$
<b>PWM Dimming</b>						
Enable Input Voltage	$V_{EN}$	—	—	<b>0.4</b>	V	Logic low
		<b>1.4</b>	—	—		Logic high
Enable Input Current	$I_{EN}$	—	0.01	<b>1</b>	$\mu A$	$V_{EN} \geq 1.4V$
Current Source Delay (50% Levels)		—	32	80	$\mu s$	Shutdown to ON
		—	1.5	4		Standby to ON
		—	0.3	—		ON to Standby
Current Source Transient Time	$t_{RISE}$	—	0.7	—	$\mu s$	10% to 90%
	$t_{FALL}$	—	0.2	—		
ON-to-Shutdown Time	$t_{ON\_SD}$	4	5.8	10	ms	$V_{EN} = 0V$

**Note 1:** As determined by the average current of all channels in use and all channels loaded.

**2:** The current through each LED meets the stated limits from the average current of all LEDs.

# MIC2860-2P

---

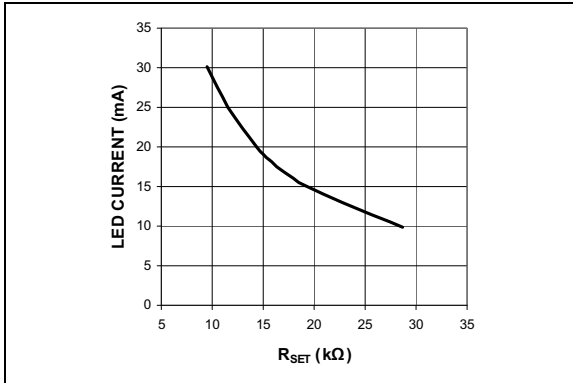
---

## TEMPERATURE SPECIFICATIONS

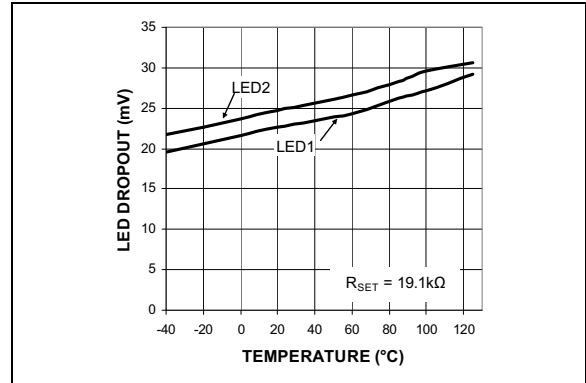
Parameters	Sym.	Min.	Typ.	Max.	Units	Conditions
<b>Temperature Ranges</b>						
Lead Temperature	$T_{LEAD}$	—	—	+260	°C	Soldering, 10 sec.
Junction Temperature Range	$T_J$	-40	—	+125	°C	—
Storage Temperature	$T_S$	-65	—	+150	°C	—
<b>Package Thermal Resistances</b>						
Thermal Resistance, SC-70 6-Ld	$\theta_{JA}$	—	256	—	°C/W	—
Thermal Resistance, TSOT 6-Ld	$\theta_{JA}$	—	177	—	°C/W	—

## 2.0 TYPICAL PERFORMANCE CURVES

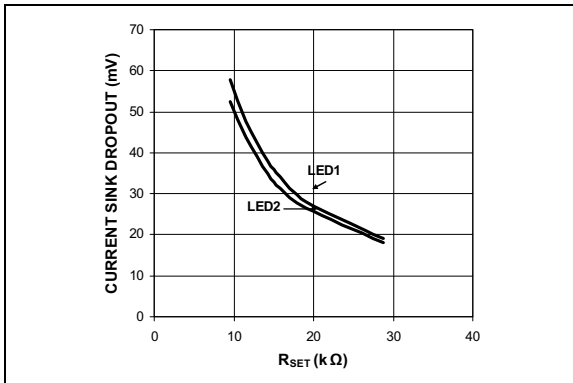
**Note:** The graphs and tables provided following this note are a statistical summary based on a limited number of samples and are provided for informational purposes only. The performance characteristics listed herein are not tested or guaranteed. In some graphs or tables, the data presented may be outside the specified operating range (e.g., outside specified power supply range) and therefore outside the warranted operating range.



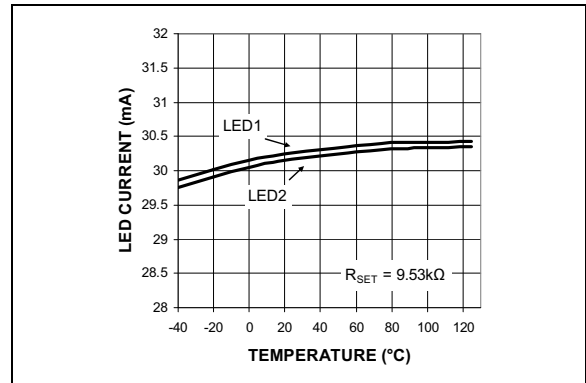
**FIGURE 2-1:** Peak LED Current vs.  $R_{SET}$ .



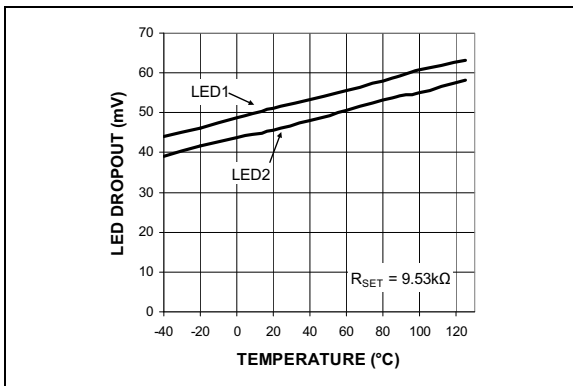
**FIGURE 2-4:** Dropout Voltage vs. Temperature.



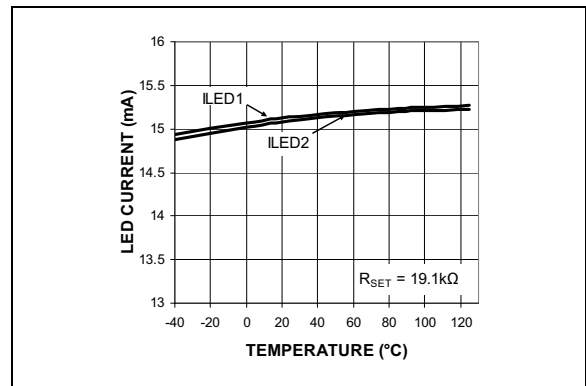
**FIGURE 2-2:** Dropout Voltage vs.  $R_{SET}$ .



**FIGURE 2-5:** LED Current vs. Temperature.

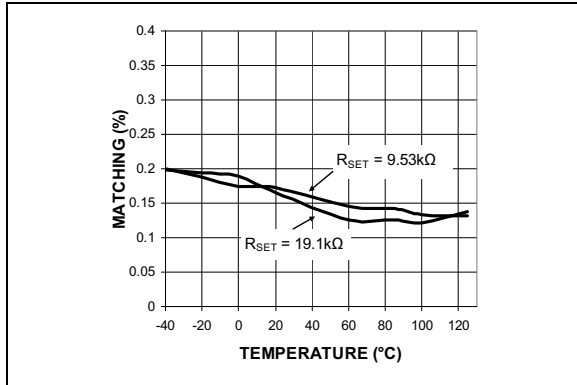


**FIGURE 2-3:** Dropout Voltage vs. Temperature.

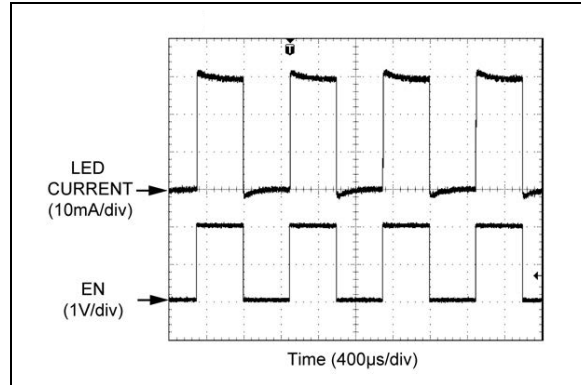


**FIGURE 2-6:** LED Current vs. Temperature.

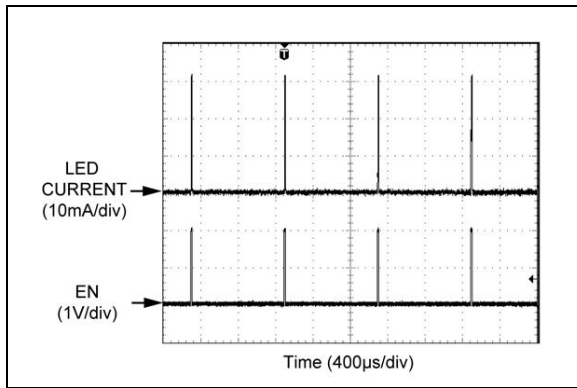
# MIC2860-2P



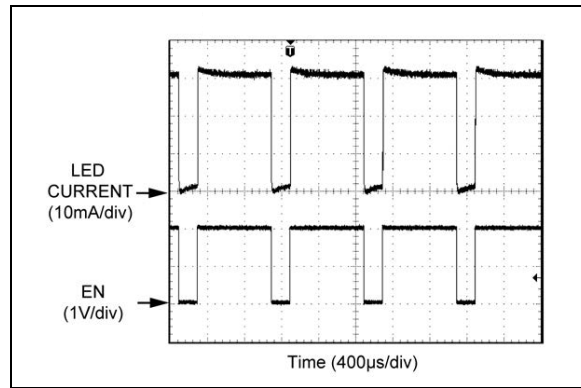
**FIGURE 2-7:** Matching vs. Temperature.



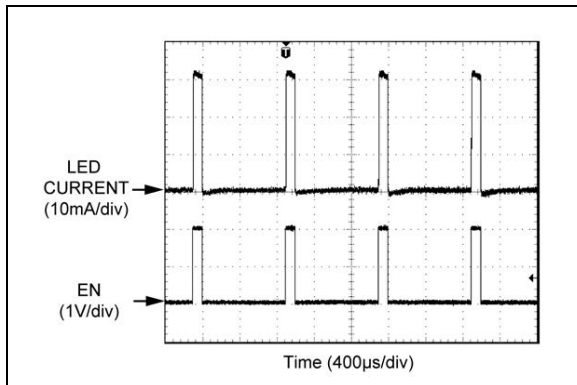
**FIGURE 2-10:** PWM Signal at 50% Duty Cycle.



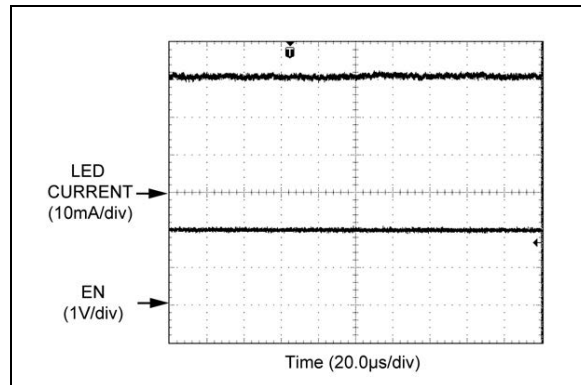
**FIGURE 2-8:** PWM Signal at 1% Duty Cycle.



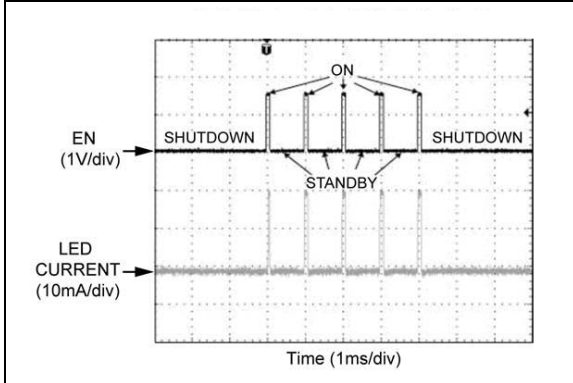
**FIGURE 2-11:** PWM Signal at 80% Duty Cycle.



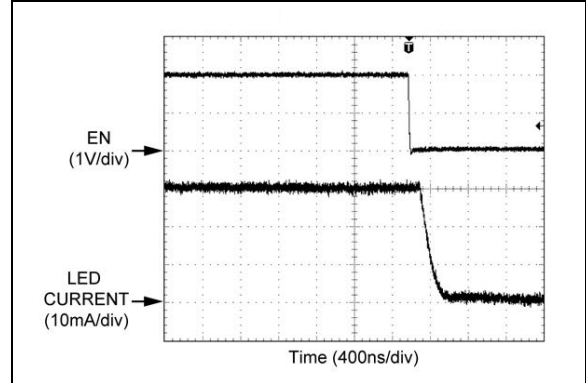
**FIGURE 2-9:** PWM Signal at 10% Duty Cycle.



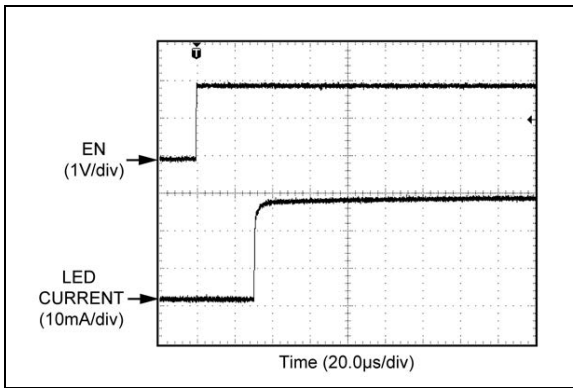
**FIGURE 2-12:** PWM Signal at 100% Duty Cycle.



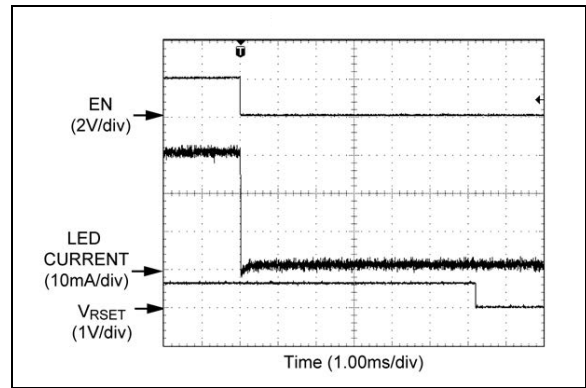
**FIGURE 2-13:** LED Startup into 10% Duty Cycle.



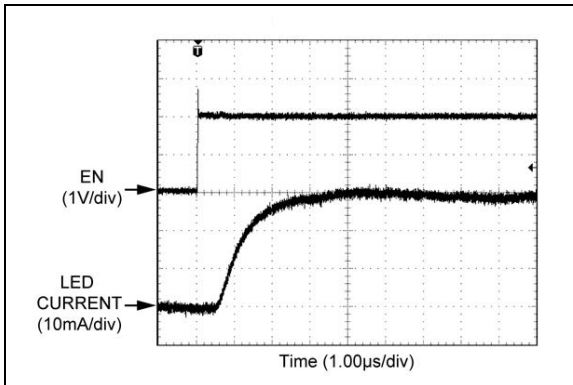
**FIGURE 2-16:** ON to Standby.



**FIGURE 2-14:** Shutdown to ON.



**FIGURE 2-17:** ON to Shutdown.



**FIGURE 2-15:** Standby to ON.

# MIC2860-2P

---

---

## 3.0 PIN DESCRIPTIONS

The descriptions of the pins are listed in [Table 3-1](#).

**TABLE 3-1: PIN FUNCTION TABLE**

Pin Number	Pin Name	Description
1	EN	PWM Control Pin. This pin is used as a PWM input for dimming of WLEDs. Do not leave floating.
2	GND	Ground.
3	VIN	Voltage Input. Connect at least 1 $\mu$ F ceramic capacitor between VIN and GND.
4	D2	LED2 driver. Connect LED anode to VIN and cathode to this pin. Do not leave floating.
5	RSET	An internal 1.27V reference sets the nominal maximum WLED current. Example, apply a 9.53 k $\Omega$ resistor between RSET and GND to set LED current to 30.2 mA at 100% duty cycle.
6	D1	LED1 driver. Connect LED anode to VIN and cathode to this pin. Do not leave floating.



## 4.0 FUNCTIONAL DESCRIPTION

The MIC2860-2P is a two channel WLED driver. The WLED driver is designed to maintain proper current regulation with LED current accuracy of 1% with a typical matching between the 2 channels of  $\pm 0.5\%$ . The WLEDs are driven independently from the input supply and will maintain regulation with a dropout of 52 mV at 30.2 mA. The low dropout of the linear drivers allows the WLEDs to be driven directly from the battery voltage and eliminates the need for large and inefficient charge pumps. The peak WLED current for each channel is set via an external resistor. If dimming is desired the MIC2860-2P can dim via a PWM signal.

### 4.1 Block Diagram

As shown in the [Functional Block Diagram](#), the MIC2860-2P consists of two current sinks with the peak current determined by  $R_{SET}$ . The linear drivers have a designated control block for enabling and dimming of the WLEDs. The MIC2860-2P is controlled by the PWM control block that receives PWM signals for dimming.

### 4.2 VIN

The input supply ( $V_{IN}$ ) provides power to the linear drivers and the control circuitry. The  $V_{IN}$  operating range is 3V to 5.5V. Due to wire inductance, a minimum bypass capacitor of 1  $\mu\text{F}$  should be placed close to input ( $V_{IN}$ ) pin and the ground (GND) pin.

### 4.3 EN

The EN pin enables the linear drivers. It can also be used for dimming with a PWM signal. See the [PWM Dimming Interface](#) section for details. Do not leave floating.

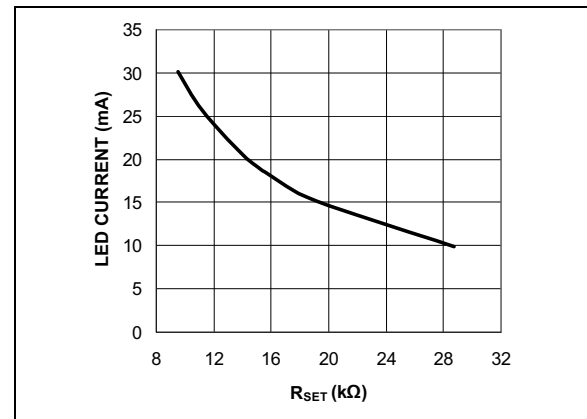
### 4.4 $R_{SET}$

The  $R_{SET}$  pin is used by connecting a  $R_{SET}$  resistor to ground to set the peak current of the linear drivers. The maximum LED current (EN = 100% Duty Cycle) set by the  $R_{SET}$  resistor is shown in the table below:

**TABLE 4-1: MAX. LED CURRENT VS.  $R_{SET}$  RESISTOR VALUES**

$R_{SET}$	$I_{LED}$
9.53 k $\Omega$	30.2 mA
11.5 k $\Omega$	25.0 mA
14.3 k $\Omega$	20.1 mA
15.8 k $\Omega$	18.2 mA
19.1 k $\Omega$	15.1 mA
28.7 k $\Omega$	10.0 mA

A plot of  $I_{LED}$  versus  $R_{SET}$  is shown in [Figure 4-1](#).



**FIGURE 4-1: Peak LED Current vs.  $R_{SET}$ .**

### 4.5 D1, D2

The D1 and D2 pins are the linear driver inputs for WLED 1 and 2, respectively. Connect the anodes of the WLEDs to  $V_{IN}$  and each cathode of the WLEDs to D1 and D2. When operating with a single WLED, D1 and D2 should be connected to the WLED cathode to parallel the outputs for improved dropout performance. Paralleling these pins can also be done to drive a higher current through a single WLED. Do not leave these pins floating.

### 4.6 GND

The ground pin is the ground path for the linear drivers. The current loop for the ground should be as small as possible. The ground of the input capacitor should be routed with low impedance traces to the GND pin and made as short as possible.

# MIC2860-2P

---

---

## 5.0 APPLICATION INFORMATION

### 5.1 PWM Dimming Interface

The MIC2860-2P can receive PWM signals from the EN pin for WLED dimming. Dimming is generated by pulsing the WLEDs on and off in synchronization with the PWM signal. The MIC2860-2P incorporates an internal shutdown delay to ensure that the internal control circuitry remains active during PWM dimming for optimum performance.

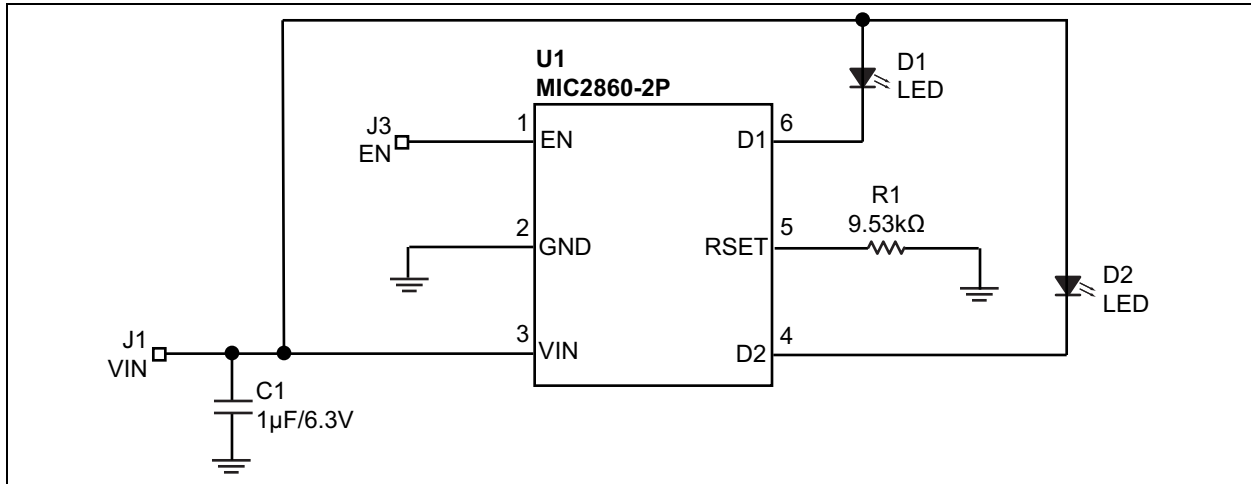
The lower PWM frequency range is recommended at 250 Hz due to the minimum standby to shutdown time of 4 ms. Because the period of 250 Hz is 4 ms, a 1% duty cycle would have an on time of 40  $\mu$ s and an off time of 3.96 ms. To support operation down to 1% duty cycle, the maximum off time must not exceed 4 ms or the drivers may go into the low  $I_Q$  shutdown state.

With PWM frequencies higher than 500 Hz the  $t_{RISE}$  (0.7  $\mu$ s) and  $t_{FALL}$  (0.2  $\mu$ s) times will have a greater effect on the accuracy of the outputs. An upper frequency of 500 Hz is recommended to maintain output accuracy with duty cycles down to 1%. For systems that do not require a duty cycle below 1%, the frequency of the PWM signal may be increased. For example, with a minimum duty cycle of 10% (3.02 mA with  $R_{SET} = 9.53 \text{ k}\Omega$ ) the PWM frequency can be increased to 10 kHz and still maintain accuracy.

### 5.2 Input Capacitor

The MIC2860-2P is a high performance, high bandwidth device. Stability can be maintained using a ceramic input capacitor of 1  $\mu$ F. Low-ESR ceramic capacitors provide optimal performance with a minimum amount of space. Additional high frequency capacitors, such as small valued NPO dielectric type capacitors, help filter out high-frequency noise and are good practice in any noise-sensitive circuit. X5R or X7R dielectrics are recommended for the input capacitor. Y5V dielectrics lose most of their capacitance over temperature and are therefore, not recommended.

## 6.0 TYPICAL APPLICATION SCHEMATIC






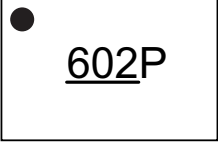

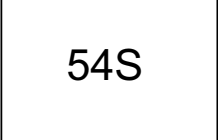

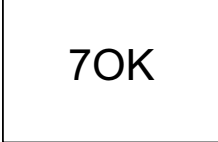
**TABLE 6-1: BILL OF MATERIALS**

Item	Part Number	Manufacturer	Description	Qty.
C1	C1608X5R0J105K	TDK	1 µF Ceramic Capacitor, 6.3V, X5R, Size 0603	1
R1	CRCW06032052FT1	Vishay	9.53 kΩ, 1%, Size 0603	1
U1	MIC2860-2PYC6	Microchip	2-Channel PWM Linear WLED Driver, SC-70	1
	MIC2860-2PYD6		2-Channel PWM Linear WLED Driver, SOT-23	

# MIC2860-2P

## 7.0 PACKAGING INFORMATION

### 7.1 Package Marking Information

6-Lead SC-70* (Front)	Example	6-Lead TSOT-23* (Front)	Example
			
6-Lead SC-70* (Back)	Example	6-Lead TSOT-23* (Back)	Example
			

<b>Legend:</b>	XX...X	Product code or customer-specific information
	Y	Year code (last digit of calendar year)
	YY	Year code (last 2 digits of calendar year)
	WW	Week code (week of January 1 is week '01')
	NNN	Alphanumeric traceability code
	(e3)	Pb-free JEDEC® designator for Matte Tin (Sn)
	*	This package is Pb-free. The Pb-free JEDEC designator (e3) can be found on the outer packaging for this package.
	•, ▲, ▼	Pin one index is identified by a dot, delta up, or delta down (triangle mark).
<b>Note:</b>	In the event the full Microchip part number cannot be marked on one line, it will be carried over to the next line, thus limiting the number of available characters for customer-specific information. Package may or may not include the corporate logo. Underbar ( ) symbol may not be to scale.	

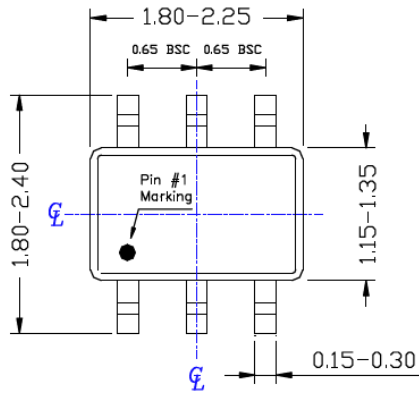
**Note:** If the full seven-character YYWWNNN code cannot fit on the package, the following truncated codes are used based on the available marking space:  
6 Characters = YWWNNN; 5 Characters = WWNNN; 4 Characters = WNNN; 3 Characters = NNN;  
2 Characters = NN; 1 Character = N

## 6-Lead SC-70 Package Outline and Recommended Land Pattern

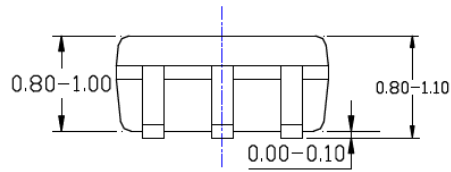
**TITLE**

6 LEAD SC70 PACKAGE OUTLINE & RECOMMENDED LAND PATTERN

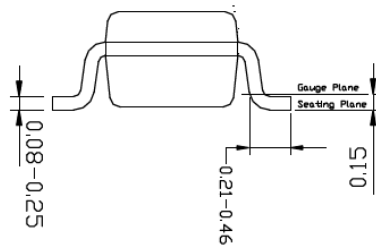
<b>DRAWING #</b>	SC70-6LD-PL-1	<b>UNIT</b>	MM
------------------	---------------	-------------	----



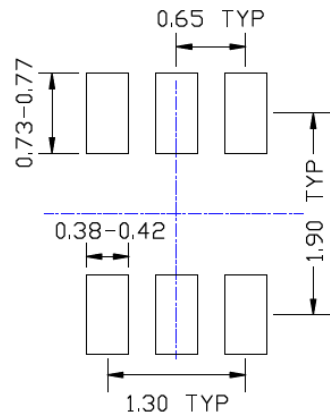
TOP VIEW



SIDE VIEW



END VIEW



RECOMMENDED  
LAND PATTERN

**NOTE:**

1. ALL DIMENSIONS ARE IN MILLIMETERS.
2. DIMENSIONS ARE INCLUSIVE OF PLATING.
3. DIMENSIONS ARE EXCLUSIVE OF MOLD FLASH & METAL BURR.

Note: For the most current package drawings, please see the Microchip Packaging Specification located at <http://www.microchip.com/packaging>.

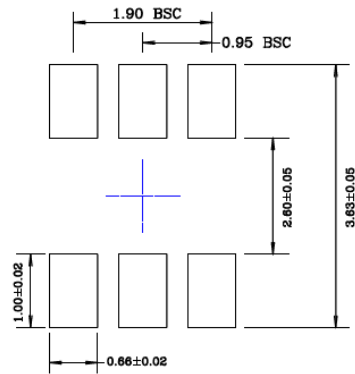
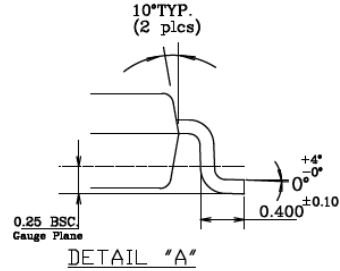
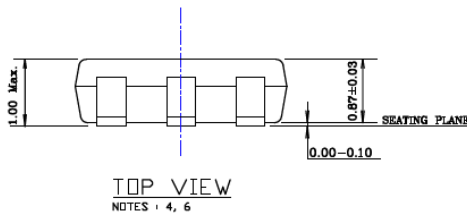
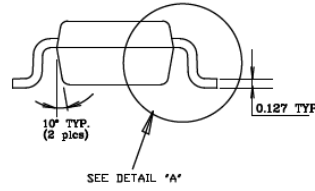
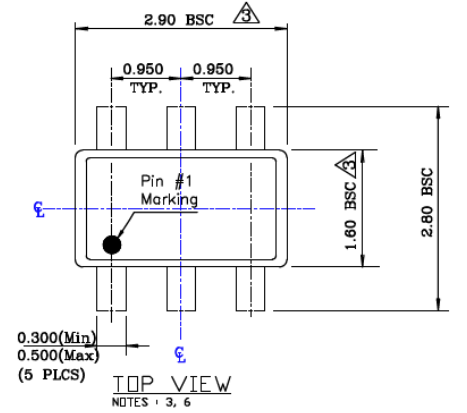
# MIC2860-2P

## 6-Lead Thin SOT-23 Package Outline and Recommended Land Pattern

**TITLE**

6 LEAD TSOT PACKAGE OUTLINE & RECOMMENDED LAND PATTERN

<b>DRAWING #</b>	TSOT-6LD-PL-1	<b>UNIT</b>	MM
------------------	---------------	-------------	----



**NOTE:**

1. Dimensions and tolerances are as per ANSI Y14.5M, 1994.
2. Die is facing up for mold. Die is facing down for trim/form, ie. reverse trim/form.
3. Dimensions are exclusive of mold flash and gate burr.
4. The footlength measuring is based on the gauge plane method.
5. All specification comply to Jedec Spec M0193 Issue C.
6. All dimensions are in millimeters.

Note: For the most current package drawings, please see the Microchip Packaging Specification located at <http://www.microchip.com/packaging>.

## APPENDIX A: REVISION HISTORY

### Revision A (June 2022)

- Converted Micrel document MIC2860-2P to Microchip data sheet DS20006695A.
- Minor text changes throughout.

# MIC2860-2P

---

---

NOTES:



## PRODUCT IDENTIFICATION SYSTEM

To order or obtain information, e.g., on pricing or delivery, contact your local Microchip representative or sales office.

<u>Part Number</u>	<u>X</u>	<u>XX</u>	<u>-XX</u>	<b>Examples:</b>
Device	Temp. Range	Package	Media Type	
<b>Device:</b>	MIC2860-2P:	High Efficiency 2-Channel WLED Driver with PWM Control		a) MIC2860-2PYC6-TR: MIC2860-2P, -40°C to +125°C Temp. Range, 6-Lead SC-70, 3,000/Reel
<b>Temperature Range:</b>	Y =	-40°C to +125°C		b) MIC2860-2PYD6-TR: MIC2860-2P, -40°C to +125°C Temp. Range, 6-Lead TSOT-23, 3,000/Reel
<b>Package:</b>	C6 =	6-Lead SC-70		<b>Note 1:</b> Tape and Reel identifier only appears in the catalog part number description. This identifier is used for ordering purposes and is not printed on the device package. Check with your Microchip Sales Office for package availability with the Tape and Reel option.
	D6 =	6-Lead Thin SOT-23		
<b>Media Type:</b>	TR =	3,000/Reel		

# MIC2860-2P

---

---

NOTES:

---

---

**Note the following details of the code protection feature on Microchip products:**

- Microchip products meet the specifications contained in their particular Microchip Data Sheet.
- Microchip believes that its family of products is secure when used in the intended manner, within operating specifications, and under normal conditions.
- Microchip values and aggressively protects its intellectual property rights. Attempts to breach the code protection features of Microchip product is strictly prohibited and may violate the Digital Millennium Copyright Act.
- Neither Microchip nor any other semiconductor manufacturer can guarantee the security of its code. Code protection does not mean that we are guaranteeing the product is "unbreakable" Code protection is constantly evolving. Microchip is committed to continuously improving the code protection features of our products.

---

This publication and the information herein may be used only with Microchip products, including to design, test, and integrate Microchip products with your application. Use of this information in any other manner violates these terms. Information regarding device applications is provided only for your convenience and may be superseded by updates. It is your responsibility to ensure that your application meets with your specifications. Contact your local Microchip sales office for additional support or, obtain additional support at <https://www.microchip.com/en-us/support/design-help/client-support-services>.

THIS INFORMATION IS PROVIDED BY MICROCHIP "AS IS". MICROCHIP MAKES NO REPRESENTATIONS OR WARRANTIES OF ANY KIND WHETHER EXPRESS OR IMPLIED, WRITTEN OR ORAL, STATUTORY OR OTHERWISE, RELATED TO THE INFORMATION INCLUDING BUT NOT LIMITED TO ANY IMPLIED WARRANTIES OF NON-INFRINGEMENT, MERCHANTABILITY, AND FITNESS FOR A PARTICULAR PURPOSE, OR WARRANTIES RELATED TO ITS CONDITION, QUALITY, OR PERFORMANCE.

IN NO EVENT WILL MICROCHIP BE LIABLE FOR ANY INDIRECT, SPECIAL, PUNITIVE, INCIDENTAL, OR CONSEQUENTIAL LOSS, DAMAGE, COST, OR EXPENSE OF ANY KIND WHATSOEVER RELATED TO THE INFORMATION OR ITS USE, HOWEVER CAUSED, EVEN IF MICROCHIP HAS BEEN ADVISED OF THE POSSIBILITY OR THE DAMAGES ARE FORESEEABLE. TO THE FULLEST EXTENT ALLOWED BY LAW, MICROCHIP'S TOTAL LIABILITY ON ALL CLAIMS IN ANY WAY RELATED TO THE INFORMATION OR ITS USE WILL NOT EXCEED THE AMOUNT OF FEES, IF ANY, THAT YOU HAVE PAID DIRECTLY TO MICROCHIP FOR THE INFORMATION.

Use of Microchip devices in life support and/or safety applications is entirely at the buyer's risk, and the buyer agrees to defend, indemnify and hold harmless Microchip from any and all damages, claims, suits, or expenses resulting from such use. No licenses are conveyed, implicitly or otherwise, under any Microchip intellectual property rights unless otherwise stated.

For information regarding Microchip's Quality Management Systems, please visit [www.microchip.com/quality](http://www.microchip.com/quality).

**Trademarks**

The Microchip name and logo, the Microchip logo, Adaptec, AVR, AVR logo, AVR Freaks, BesTime, BitCloud, CryptoMemory, CryptoRF, dsPIC, flexPWR, HELDO, IGL00, JukeBlox, KeeLoq, Klear, LANCheck, LinkMD, maXStylus, maXTouch, MediaLB, megaAVR, Microsemi, Microsemi logo, MOST, MOST logo, MPLAB, OptoLyzer, PIC, picoPower, PICSTART, PIC32 logo, PolarFire, Prochip Designer, QTouch, SAM-BA, SenGenuity, SpyNIC, SST, SST Logo, SuperFlash, Symmetricom, SyncServer, Tachyon, TimeSource, tinyAVR, UNI/O, Vectron, and XMEGA are registered trademarks of Microchip Technology Incorporated in the U.S.A. and other countries.

AgileSwitch, APT, ClockWorks, The Embedded Control Solutions Company, EtherSynch, Flashtec, Hyper Speed Control, HyperLight Load, Libero, motorBench, mTouch, Powermite 3, Precision Edge, ProASIC, ProASIC Plus, ProASIC Plus logo, Quiet-Wire, SmartFusion, SyncWorld, Temux, TimeCesium, TimeHub, TimePictra, TimeProvider, TrueTime, and ZL are registered trademarks of Microchip Technology Incorporated in the U.S.A.

Adjacent Key Suppression, AKS, Analog-for-the-Digital Age, Any Capacitor, AnyIn, AnyOut, Augmented Switching, BlueSky, BodyCom, Clockstudio, CodeGuard, CryptoAuthentication, CryptoAutomotive, CryptoCompanion, CryptoController, dsPICDEM, dsPICDEM.net, Dynamic Average Matching, DAM, ECAN, Espresso T1S, EtherGREEN, GridTime, IdealBridge, In-Circuit Serial Programming, ICSP, INICnet, Intelligent Paralleling, IntelliMOS, Inter-Chip Connectivity, JitterBlocker, Knob-on-Display, KoD, maxCrypto, maxView, memBrain, Mindi, MiWi, MPASM, MPF, MPLAB Certified logo, MPLIB, MPLINK, MultiTRAK, NetDetach, Omniscient Code Generation, PICDEM, PICDEM.net, PICkit, PICtail, PowerSmart, PureSilicon, QMatrix, REAL ICE, Ripple Blocker, RTAX, RTG4, SAM-ICE, Serial Quad I/O, simpleMAP, SimpliPHY, SmartBuffer, SmartHLS, SMART-I.S., storClad, SQI, SuperSwitcher, SuperSwitcher II, Switchtec, SynchroPHY, Total Endurance, Trusted Time, TSHARC, USBCheck, VariSense, VectorBlox, VeriPHY, ViewSpan, WiperLock, XpressConnect, and ZENA are trademarks of Microchip Technology Incorporated in the U.S.A. and other countries.

SQTP is a service mark of Microchip Technology Incorporated in the U.S.A.

The Adaptec logo, Frequency on Demand, Silicon Storage Technology, and Symmcom are registered trademarks of Microchip Technology Inc. in other countries.

GestIC is a registered trademark of Microchip Technology Germany II GmbH & Co. KG, a subsidiary of Microchip Technology Inc., in other countries.

All other trademarks mentioned herein are property of their respective companies.

© 2022, Microchip Technology Incorporated and its subsidiaries.

All Rights Reserved.

ISBN: 978-1-6683-0622-2



# MICROCHIP

## Worldwide Sales and Service

### AMERICAS

**Corporate Office**  
2355 West Chandler Blvd.  
Chandler, AZ 85224-6199  
Tel: 480-792-7200  
Fax: 480-792-7277  
Technical Support:  
<http://www.microchip.com/support>  
Web Address:  
[www.microchip.com](http://www.microchip.com)

#### Atlanta

Duluth, GA  
Tel: 678-957-9614  
Fax: 678-957-1455

#### Austin, TX

Tel: 512-257-3370

#### Boston

Westborough, MA  
Tel: 774-760-0087  
Fax: 774-760-0088

#### Chicago

Itasca, IL  
Tel: 630-285-0071  
Fax: 630-285-0075

#### Dallas

Addison, TX  
Tel: 972-818-7423  
Fax: 972-818-2924

#### Detroit

Novi, MI  
Tel: 248-848-4000

#### Houston, TX

Tel: 281-894-5983

#### Indianapolis

Noblesville, IN  
Tel: 317-773-8323  
Fax: 317-773-5453  
Tel: 317-536-2380

#### Los Angeles

Mission Viejo, CA  
Tel: 949-462-9523  
Fax: 949-462-9608  
Tel: 951-273-7800

#### Raleigh, NC

Tel: 919-844-7510

#### New York, NY

Tel: 631-435-6000

#### San Jose, CA

Tel: 408-735-9110  
Tel: 408-436-4270

#### Canada - Toronto

Tel: 905-695-1980  
Fax: 905-695-2078

### ASIA/PACIFIC

**Australia - Sydney**  
Tel: 61-2-9868-6733

**China - Beijing**  
Tel: 86-10-8569-7000

**China - Chengdu**  
Tel: 86-28-8665-5511

**China - Chongqing**  
Tel: 86-23-8980-9588

**China - Dongguan**  
Tel: 86-769-8702-9880

**China - Guangzhou**  
Tel: 86-20-8755-8029

**China - Hangzhou**  
Tel: 86-571-8792-8115

**China - Hong Kong SAR**  
Tel: 852-2943-5100

**China - Nanjing**  
Tel: 86-25-8473-2460

**China - Qingdao**  
Tel: 86-532-8502-7355

**China - Shanghai**  
Tel: 86-21-3326-8000

**China - Shenyang**  
Tel: 86-24-2334-2829

**China - Shenzhen**  
Tel: 86-755-8864-2200

**China - Suzhou**  
Tel: 86-186-6233-1526

**China - Wuhan**  
Tel: 86-27-5980-5300

**China - Xian**  
Tel: 86-29-8833-7252

**China - Xiamen**  
Tel: 86-592-2388138

**China - Zhuhai**  
Tel: 86-756-3210040

### ASIA/PACIFIC

**India - Bangalore**  
Tel: 91-80-3090-4444

**India - New Delhi**  
Tel: 91-11-4160-8631

**India - Pune**  
Tel: 91-20-4121-0141

**Japan - Osaka**  
Tel: 81-6-6152-7160

**Japan - Tokyo**  
Tel: 81-3-6880-3770

**Korea - Daegu**  
Tel: 82-53-744-4301

**Korea - Seoul**  
Tel: 82-2-554-7200

**Malaysia - Kuala Lumpur**  
Tel: 60-3-7651-7906

**Malaysia - Penang**  
Tel: 60-4-227-8870

**Philippines - Manila**  
Tel: 63-2-634-9065

**Singapore**  
Tel: 65-6334-8870

**Taiwan - Hsin Chu**  
Tel: 886-3-577-8366

**Taiwan - Kaohsiung**  
Tel: 886-7-213-7830

**Taiwan - Taipei**  
Tel: 886-2-2508-8600

**Thailand - Bangkok**  
Tel: 66-2-694-1351

**Vietnam - Ho Chi Minh**  
Tel: 84-28-5448-2100

### EUROPE

**Austria - Wels**  
Tel: 43-7242-2244-39  
Fax: 43-7242-2244-393

**Denmark - Copenhagen**  
Tel: 45-4485-5910  
Fax: 45-4485-2829

**Finland - Espoo**  
Tel: 358-9-4520-820

**France - Paris**  
Tel: 33-1-69-53-63-20  
Fax: 33-1-69-30-90-79

**Germany - Garching**  
Tel: 49-8931-9700

**Germany - Haan**  
Tel: 49-2129-3766400

**Germany - Heilbronn**  
Tel: 49-7131-72400

**Germany - Karlsruhe**  
Tel: 49-721-625370

**Germany - Munich**  
Tel: 49-89-627-144-0  
Fax: 49-89-627-144-44

**Germany - Rosenheim**  
Tel: 49-8031-354-560

**Israel - Ra'anana**  
Tel: 972-9-744-7705

**Italy - Milan**  
Tel: 39-0331-742611  
Fax: 39-0331-466781

**Italy - Padova**  
Tel: 39-049-7625286

**Netherlands - Drunen**  
Tel: 31-416-690399  
Fax: 31-416-690340

**Norway - Trondheim**  
Tel: 47-7288-4388

**Poland - Warsaw**  
Tel: 48-22-3325737

**Romania - Bucharest**  
Tel: 40-21-407-87-50

**Spain - Madrid**  
Tel: 34-91-708-08-90  
Fax: 34-91-708-08-91

**Sweden - Gothenberg**  
Tel: 46-31-704-60-40

**Sweden - Stockholm**  
Tel: 46-8-5090-4654

**UK - Wokingham**  
Tel: 44-118-921-5800  
Fax: 44-118-921-5820