

IEC Appliance Inlet C14 or C18 with Filter, Protection Degree IP65 into the Appliance, Fuseholder 1- or 2-pole, Front or Rear Mounting



IEC connector C14 or C18 with filter
 Screw-on from front side

With V-Lock Connection
 white
 5707.xxx.xxx.22 with IP54 V-Lock cord connection

from front side
 white
 5707 with IP54 Inlet Gasket



See below:
[Approvals and Compliances](#)

Description

- Panel mount :
 Screw-on version from front or rear side , Screws with sealing are included
- 4 Functions :
 Appliance Inlet protection class I or II , Line filter in standard and medical version , Fuseholder for fuse-links 5 x 20 mm , IP65 protection into the appliance
- For front side mounting versions a sealing kit IP54 for the power supply connection is available as an accessory: 4700.0021
- Option suffix ".22" offers IP54 for the power input in combination with V-Lock cordsets
- Quick connect terminals 6.3 x 0.8 mm

Unique Selling Proposition

- Sealed power entry module
- Strong in Design and Safety
- IP 65 protection to the appliance
- IP 54 protection to the cord connection

Characteristics

- Extreme robust design
- All single elements are already wired
- Screw type fuse carrier, slotted
- With EMC-shield
- Especially for applications in rough environments (see technical data)
- For applications according IEC/UL 62368-1 we recommend variants with bleed resistor
 Suitable for use in medical equipment according to IEC/UL 60601-1 (1 MOOP, 1 MOPP)

Other versions on request

- Class X1- and Y1-capacitors for enhanced withstand voltage
- Medical Version (M80)
- Additional factory-mounted sealing (IP54) of power input
- Version with current rating 3 A

Weblinks

[pdf data sheet](#), [html datasheet](#), [General Product Information](#), [Approvals](#), [Distributor-Stock-Check](#), [Accessories](#), [Detailed request for product](#)

Newly available variants corresponding to V-Lock mating cordset. The connector is equipped with a notch intended for use with the latching cordset. The cord latching system prevents against accidental removal of the cordset.

Technical Data

| | | | |
|---------------------------------|--|-----------------------------------|--|
| Ratings IEC | 1 - 8A @ Ta 40 °C / 250VAC; 50Hz | Appliance inlet/-outlet | C14 / C18 acc. to IEC 60320-1 |
| Ratings UL/CSA | 1 - 8A @ Ta 40 °C / 250VAC; 60Hz | | UL 498, CSA C22.2 no. 42 (for cold conditions) pin-temperature 70 °C, 8A, Protection Class I or II |
| Leakage Current | standard < 0.5mA (250V / 60Hz) medical < 5 µA (250 V / 60 Hz) | Fuseholder | 1-/2-pole, Shocksafe category PC2 acc. to IEC 60127-6, for fuse-links 5 x 20mm |
| Dielectric Strength | > 1.7kVDC between L-N > 2.7kVDC between L/N-PE Test voltage (2sec) > 4.0kVDC Protection class II between L/N-PE | Rated Power Acceptance @ Ta 23 °C | 5 x 20: 1.6W 1-pole/ 1,2W 2-pole per pole |
| Allowable Operation Temperature | -25 °C to 85 °C | Power Acceptance @ Ta > 23°C | Admissible power acceptance at higher ambient temperature see derating curves |
| Climatic Category | 25/085/21 acc. to IEC 60068-1 | Line Filter | Standard and Medical Version, IEC 60939, UL 1283, CSA C22.2 no. 8 Technical Details |
| IP-Protection | front side IP65 acc. to IEC 60529 rear-side IP65 acc. to IEC 60529 | MTBF | > 2'800'000h acc. to MIL-HB-217 F |
| Protection Class | Suitable for appliances with protection class I or II acc. to IEC 61140 | | |
| Terminal | Quick connect terminals 6.3 x 0.8 mm | | |
| Panel Thickness S | Screw, max 3mm Mounting screw torque max 0.8Nm 2 screws M3 with sealing are provided | | |
| Material | black / white / metallic, UL 94V-0 | | |

Approvals and Compliances



Detailed information on product approvals, code requirements, usage instructions and detailed test conditions can be looked up in [Details about Approvals](#)

SCHURTER products are designed for use in industrial environments. They have approvals from independent testing bodies according to national and international standards. Products with specific characteristics and requirements such as required in the automotive sector according to IATF 16949, medical technology according to ISO 13485 or in the aerospace industry can be offered exclusively with customer-specific, individual agreements by SCHURTER.

Approvals









The approval mark is used by the testing authorities to certify compliance with the safety requirements placed on electronic products.

Approval Reference Type: 5707

| Approval Logo | Certificates | Certification Body | Description |
|--|-------------------------------|--------------------|--|
|  | VDE Approvals | VDE | Certificate Number: 40016382 |
|  | UL Approvals | UL | UR File Number: E72928 |
|  | CQC Approvals | CQC | CQC Certificate Number: CQC21001310097 |



Product standards

Product standards that are referenced

| Organization | Design | Standard | Description |
|--|-----------------------|------------------|---|
|  | Designed according to | IEC 60320-1 | Appliance couplers for household and similar general purposes |
|  | Designed according to | IEC 60939 | Passive filters for suppressing electromagnetic interference |
|  | Designed according to | IEC 60127-6 | Miniature fuses. Part 6. Fuse-holders for miniature fuse-links |
|  | Designed according to | IEC 61058-1 | Switches for appliances. Part 1. General requirements |
|  | Designed according to | UL 498 | Standard for Attachment Plugs and Receptacles |
|  | Designed according to | UL 1283 | Electromagnetic interference filters |
|  | Designed according to | CSA C22.2 no. 42 | General Use Receptacles, Attachment Plugs, and Similar Wiring Devices |
|  | Designed according to | CSA C22.2 no. 8 | Electromagnetic interference (EMI) filters |









Application standards

Application standards where the product can be used

| Organization | Design | Standard | Description |
|--|--------------------------------|----------------|--|
|  | Suitable for applications acc. | IEC/UL 62368-1 | Audio/video, information and communication technology equipment - Part 1: Safety requirements |
|  | Suitable for applications acc. | IEC 60601-1 | Medical electrical equipment - Part 1: General requirements for basic safety and essential performance |
|  | Suitable for applications acc. | IEC 60335-1 | Safety of electrical appliances for household and similar purposes. Meets the requirements for appliances in unattended use. This includes the enhanced requirements of glow wire tests acc. to IEC 60695-2-11 or -12 & -13. |

Compliances

The product complies with following Guide Lines

| Identification | Details | Initiator | Description |
|---|--|-------------|--|
|  | CE declaration of conformity | SCHURTER AG | The CE marking declares that the product complies with the applicable requirements laid down in the harmonisation of Community legislation on its affixing in accordance with EU Regulation 765/2008. |
|  | UKCA declaration of conformity | SCHURTER AG | The UKCA marking declares that the product complies with the applicable requirements laid down in the British Amendment of Regulation (EC) 765/2008. |
|  | RoHS | SCHURTER AG | Directive RoHS 2011/65/EU, Amendment (EU) 2015/863 |
|  | China RoHS | SCHURTER AG | The law SJ / T 11363-2006 (China RoHS) has been in force since 1 March 2007. It is similar to the EU directive RoHS. |
|  | REACH | SCHURTER AG | On 1 June 2007, Regulation (EC) No 1907/2006 on the Registration, Evaluation, Authorization and Restriction of Chemicals 1 (abbreviated as "REACH") entered into force. |
|  | | SCHURTER AG | V-Lock system are based on a matching plug-dose combination. The connector is equipped with a notch intended for use with the latching cordset. The cord latching system prevents against accidental removal of the cordset. |
|  | White Paper Glow wire test | SCHURTER AG | Meets the requirements of IEC 60335-1 for appliances in unattended use. This includes the enhanced requirements of glow wire tests acc. to IEC 60695-2-11 or -12 &-13. |
|  | Medical Equipment | SCHURTER AG | Suitable for use in medical equipment according to IEC/UL 60601-1 (1 MOOP, 1 MOPP) |

Dimensions [mm]

Mounting from front side

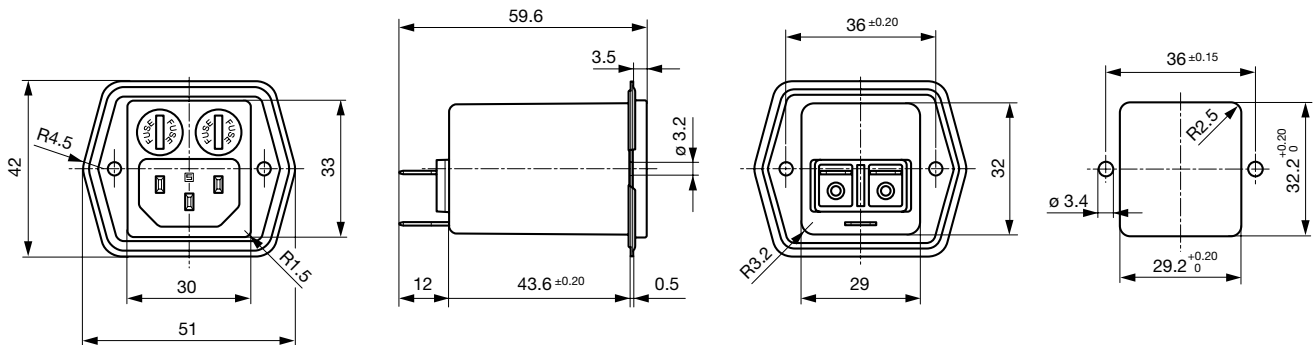

Mounting from rear side

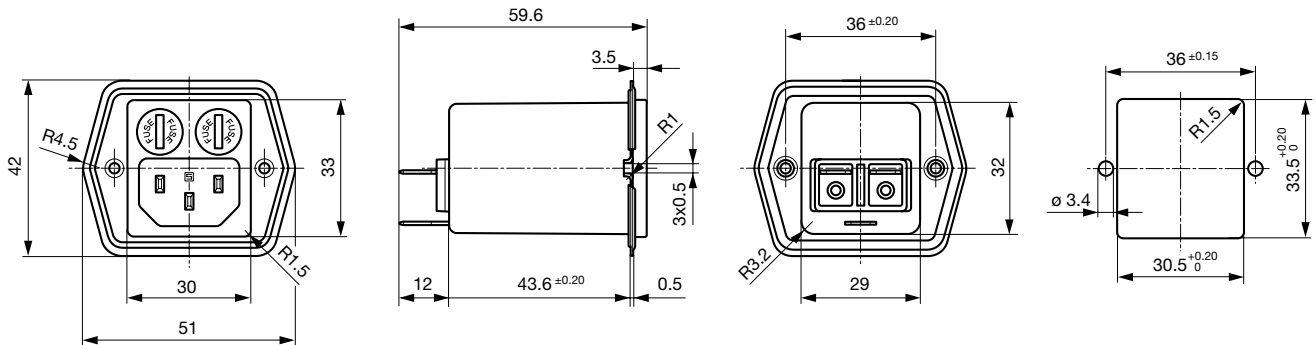

Fixing Screws M3

Assembly Instructions
 Mounting standard version

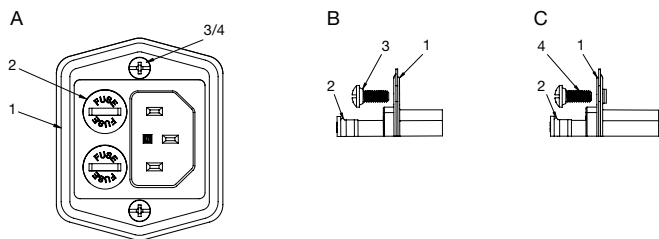

A) front view
 B) detail front mounting type
 C) detail rear mounting type

- 1) sealing of flange
- 2) sealing of fuseholder
- 3) sealing of screw hole (front mounting type: sealing ring on screw head)
- 4) sealing of screw hole (rear mounting type: sealing on screw thread)

Important:

- use supplied fuse caps (2) and mounting screws (3/4)
- optimal sealing requires even and solid panel opening
- recommended tightening torque for mounting screws (3/4): 0.5-0.8 Nm
- recommended tightening torque for fuse holder (2): 0.4 Nm
- IP65 protection between the inlet and connector pins, but no IP rating between the connector pins and the plug of the power cord!

Technical Data of Filter-Components

| Rated Current [A] | Filter-Type | Inductances L [mH] | Capacitance CX [nF] | Capacitance CY [nF] | R [MΩ] | | | | | | | | | | | |
|-------------------|-----------------------|--------------------|---------------------|--|--------|-----------------------|---------|-----|------|---|---|-----------------------|-------|-----|------|---|
| 1 | Standard version | 2 x 12 | 100 | 2.2 | 1 | | | | | | | | | | | |
| 2 | Standard version | 2 x 5.2 | 100 | 2.2 | 1 | | | | | | | | | | | |
| 4 | Standard version | 2 x 2 | 100 | 2.2 | 1 | | | | | | | | | | | |
| 6 | Standard version | 2 x 0.8 | 100 | 2.2 | 1 | | | | | | | | | | | |
| 8 | Standard version | 2 x 0.4 | 100 | 2.2 | 1 | | | | | | | | | | | |
| 1 | Medical Version (M5) | 2 x 12 | 100 | - | 1 | | | | | | | | | | | |
| 2 | Medical Version (M5) | 2 x 5.2 | 100 | - | 1 | | | | | | | | | | | |
| 4 | Medical Version (M5) | 2 x 2 | 100 | - | 1 | | | | | | | | | | | |
| 6 | Medical Version (M5) | 2 x 0.8 | 100 | - | 1 | | | | | | | | | | | |
| 8 | Medical Version (M5) | 2 x 0.4 | 100 | - </tr <tr> <td>2</td> <td>Medical Version (M80)</td> <td>2 x 5.2</td> <td>100</td> <td>0.47</td> <td>1</td> </tr> <tr> <td>4</td> <td>Medical Version (M80)</td> <td>2 x 2</td> <td>100</td> <td>0.47</td> <td>1</td> </tr> | 2 | Medical Version (M80) | 2 x 5.2 | 100 | 0.47 | 1 | 4 | Medical Version (M80) | 2 x 2 | 100 | 0.47 | 1 |
| 2 | Medical Version (M80) | 2 x 5.2 | 100 | 0.47 | 1 | | | | | | | | | | | |
| 4 | Medical Version (M80) | 2 x 2 | 100 | 0.47 | 1 | | | | | | | | | | | |

Diagrams

Standard version

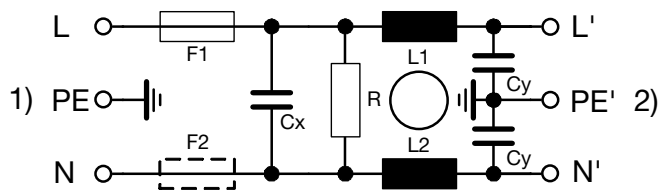

1) Line
 2) Load

Medical Version (M5)

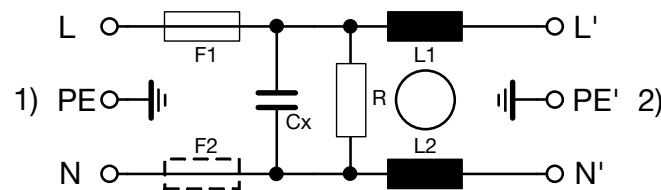

1) Line
 2) Load

Derating Curves

1-pole

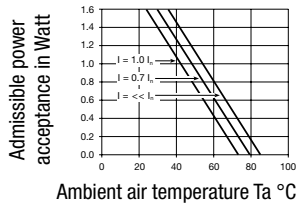

2-pole

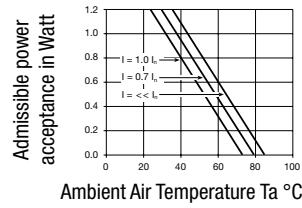

Attenuation Loss

- - - 50Ω differential mode ____ 50Ω common mode

Standard version

1 A

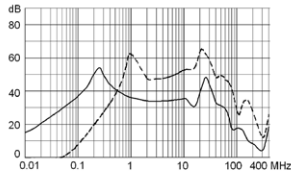

2 A

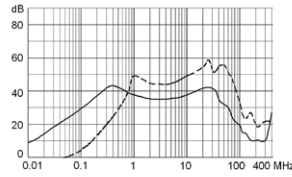

4 A

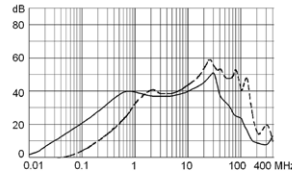

6 A

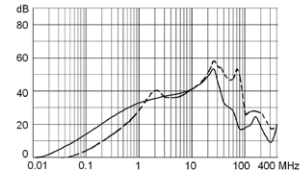

8 A

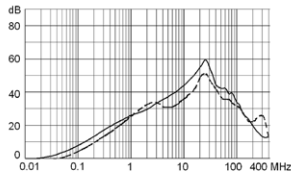

Medical version (M5)

1 A

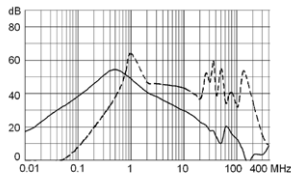

2 A

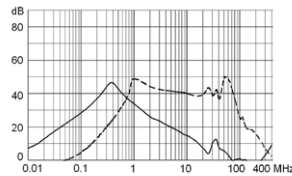

4 A

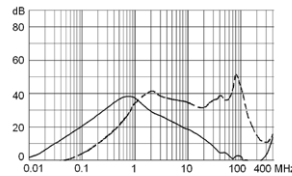

6 A

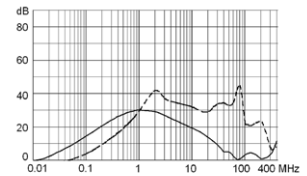

8 A

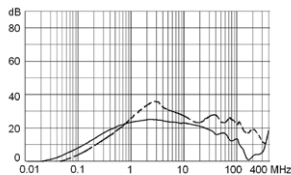

All Variants

| Rated Current [A] | Filter-Type | Mounting side | Cord retaining kits | Protection Class | Power Cord IP-protection | Fuseholder | Color | V-Lock | Order Number |
|-------------------|------------------|---------------|---------------------|------------------|--------------------------|------------|-------|--------|---------------|
| 1 | Standard version | Front Side | - | I | - | 1-pole | black | | 5707.0101.112 |
| 1 | Standard version | Rear Side | - | I | - | 1-pole | black | | 5707.0101.113 |
| 2 | Standard version | Front Side | - | I | - | 1-pole | black | | 5707.0201.112 |

| Rated Current [A] | Filter-Type | Mounting side | Cord retaining kits | Protection Class | Power Cord IP-protection | Fuseholder | Color | V-Lock | Order Number |
|-------------------|----------------------|---------------|---------------------|------------------|--------------------------|------------|-------|--------|------------------|
| 2 | Standard version | Rear Side | - | I | - | 1-pole | black | | 5707.0201.113 |
| 4 | Standard version | Front Side | - | I | - | 1-pole | black | | 5707.0401.112 |
| 4 | Standard version | Rear Side | - | I | - | 1-pole | black | | 5707.0401.113 |
| 6 | Standard version | Front Side | - | I | - | 1-pole | black | | 5707.0601.112 |
| 6 | Standard version | Rear Side | - | I | - | 1-pole | black | | 5707.0601.113 |
| 8 | Standard version | Front Side | - | I | - | 1-pole | black | | 5707.0801.112 |
| 8 | Standard version | Rear Side | - | I | - | 1-pole | black | | 5707.0801.113 |
| 1 | Standard version | Front Side | - | I | - | 2-pole | black | | 5707.0101.312 |
| 1 | Standard version | Rear Side | - | I | - | 2-pole | black | | 5707.0101.313 |
| 2 | Standard version | Front Side | - | I | - | 2-pole | black | | 5707.0201.312 |
| 2 | Standard version | Rear Side | - | I | - | 2-pole | black | | 5707.0201.313 |
| 4 | Standard version | Front Side | - | I | - | 2-pole | black | | 5707.0401.312 |
| 4 | Standard version | Rear Side | - | I | - | 2-pole | black | | 5707.0401.313 |
| 4 | Standard version | Rear Side | - | I | IP54 | 2-pole | black | ● | 5707.0401.313.22 |
| 6 | Standard version | Front Side | - | I | - | 2-pole | black | | 5707.0601.312 |
| 6 | Standard version | Rear Side | - | I | - | 2-pole | black | | 5707.0601.313 |
| 8 | Standard version | Front Side | - | I | - | 2-pole | black | | 5707.0801.312 |
| 8 | Standard version | Front Side | - | I | IP54 | 2-pole | black | | 5707.0801.312.01 |
| 8 | Standard version | Rear Side | - | I | - | 2-pole | black | | 5707.0801.313 |
| 8 | Standard version | Rear Side | - | I | - | 2-pole | black | ● | 5707.0801.313.21 |
| 1 | Medical Version (M5) | Front Side | - | I | - | 2-pole | black | | 5707.0103.312 |
| 1 | Medical Version (M5) | Rear Side | - | I | - | 2-pole | black | | 5707.0103.313 |
| 1 | Medical Version (M5) | Rear Side | - | I | - | 2-pole | black | ● | 5707.0103.313.21 |
| 2 | Medical Version (M5) | Front Side | - | I | - | 2-pole | black | | 5707.0203.312 |
| 2 | Medical Version (M5) | Rear Side | - | I | - | 2-pole | black | | 5707.0203.313 |
| 2 | Medical Version (M5) | Rear Side | - | I | - | 2-pole | black | ● | 5707.0203.313.21 |
| 4 | Medical Version (M5) | Rear Side | - | I | IP54 | 2-pole | black | ● | 3-100-897 |
| 4 | Medical Version (M5) | Front Side | - | I | - | 2-pole | black | | 5707.0403.312 |
| 4 | Medical Version (M5) | Rear Side | - | I | - | 2-pole | black | | 5707.0403.313 |
| 4 | Medical Version (M5) | Rear Side | - | I | - | 2-pole | black | ● | 5707.0403.313.21 |
| 6 | Medical Version (M5) | Front Side | - | I | - | 2-pole | black | | 5707.0603.312 |
| 6 | Medical Version (M5) | Rear Side | - | I | - | 2-pole | black | | 5707.0603.313 |
| 6 | Medical Version (M5) | Rear Side | - | I | - | 2-pole | black | ● | 5707.0603.313.21 |
| 6 | Medical Version (M5) | Front Side | - | I | - | 2-pole | white | | 5707.0613.312 |
| 6 | Medical Version (M5) | Front Side | - | I | - | 2-pole | white | ● | 5707.0613.312.21 |
| 6 | Medical Version (M5) | Rear Side | - | I | - | 2-pole | white | | 5707.0613.313 |
| 6 | Medical Version (M5) | Rear Side | - | I | - | 2-pole | white | ● | 5707.0613.313.21 |
| 8 | Medical Version (M5) | Front Side | - | I | - | 2-pole | black | | 5707.0803.312 |
| 8 | Medical Version (M5) | Front Side | - | I | IP54 | 2-pole | black | ● | 5707.0803.312.22 |
| 8 | Medical Version (M5) | Rear Side | - | I | - | 2-pole | black | | 5707.0803.313 |
| 8 | Medical Version (M5) | Rear Side | - | I | - | 2-pole | black | ● | 5707.0803.313.21 |
| 1 | Medical Version (M5) | Front Side | - | II | - | 2-pole | black | | 5707.0103.412 |
| 1 | Medical Version (M5) | Rear Side | - | II | - | 2-pole | black | | 5707.0103.413 |
| 2 | Medical Version (M5) | Front Side | - | II | - | 2-pole | black | | 5707.0203.412 |
| 2 | Medical Version (M5) | Rear Side | - | II | - | 2-pole | black | | 5707.0203.413 |
| 4 | Medical Version (M5) | Front Side | - | II | - | 2-pole | black | | 5707.0403.412 |
| 4 | Medical Version (M5) | Rear Side | - | II | - | 2-pole | black | | 5707.0403.413 |

| Rated Current [A] | Filter-Type | Mounting side | Cord retaining kits | Protection Class | Power Cord IP-protection | Fuseholder | Color | V-Lock | Order Number |
|-------------------|-----------------------|---------------|---------------------|------------------|--------------------------|------------|-------|--------|------------------|
| 6 | Medical Version (M5) | Front Side | - | II | - | 2-pole | black | | 5707.0603.412 |
| 6 | Medical Version (M5) | Rear Side | - | II | - | 2-pole | black | | 5707.0603.413 |
| 8 | Medical Version (M5) | Front Side | - | II | - | 2-pole | black | | 5707.0803.412 |
| 8 | Medical Version (M5) | Rear Side | - | II | - | 2-pole | black | | 5707.0803.413 |
| 2 | Medical Version (M80) | Front Side | - | I | IP54 | 2-pole | black | | 5707.0205.312.01 |
| 4 | Medical Version (M80) | Rear Side | - | I | IP54 | 2-pole | black | | 3-121-413 |

Most Popular.

Availability for all products can be searched real-time: <https://www.schurter.com/en/Stock-Check/Stock-Check-SCHURTER>

Packaging unit 10 Pcs

Accessories

Description



Wire_Harness
 Wire harness for SCHURTER products



Assorted_Covers
 Rear Cover

0859.0047



RC320
 Rear Cover for Power Entry Module

Mating Outlets/Connectors

Category / Description

[Connector Overview complete](#)



| | |
|---|---------|
| 4782 Mounting: Power Cord, 3 x 1 mm ² / 3 x 18 AWG, Cable, Connector: IEC C13 | 4782 |
| 4785 Mounting: Power Cord, 3 x 1 mm ² / 3 x 18 AWG, Cable, Connector: IEC C13 | 4785 |
| 4300-06 Mounting: Power Cord, 3 x 1 mm ² / 3 x 18 AWG, Cable, Connector: IEC C13 | 4300-06 |
| 4781 Mounting: Power Cord, Cable, Connector: IEC C15 | 4781 |
| 4784 Mounting: Power Cord, 3 x 1 mm ² / 3 x 18 AWG, Cable, Connector: IEC C15 | 4784 |

...

[Interconnection Cord Overview complete](#)

| | |
|--|-----------|
| Cord Sets 10 A, Interconnection, 2.0 m, IEC H05VV-F3G1.0, black | 6007.0204 |
| Cord Sets 10 A, Interconnection, 1.0 m, Connector IEC C13, H05VV-F3G1.0, black | 6007.0212 |
| Cord Sets 10 A, Interconnection, 2.0 m, Connector IEC C13, H05VV-F3G1.0, black | 6007.0214 |

[Power Supply Cord Overview complete](#)

| | |
|--|-----------|
| Cord Sets 10 A, Europlug, 2.5 m, Connector IEC C13, H05VV-F3G1.0, black | 6004.0215 |
| Cord Sets 10 A, Europlug, 2.5 m, Connector IEC C13, H05VV-F3G1.0, black | 6003.0215 |
| Cord Sets 10 A, uninsulated wires, 2.0 m, Connector IEC C13, H05VV-F3G1.0, black | 6000.0224 |
| Cord Sets 10 A, uninsulated wires, 2.0 m, Connector IEC C13, H05VV-F3G1.0, black | 6000.0214 |
| Cord Sets 10 A, United Kingdom, 2.5 m, Connector IEC C13, H05VV-F3G1.0, black | 6044.0215 |

...

[Power Supply or Interconnection Cord Overview complete](#)

| | |
|--|-----------|
| Cord Sets 10 A, United Kingdom, 2.0 m, Connector IEC H05VV-F3G1.0, black | 6044.0204 |
|--|-----------|

Mating Outlets/Connectors shuttered[Connector Overview complete](#)

| | |
|--|------|
| 4783 Mounting: Power Cord, 3 x 1 mm ² / 3 x 18 AWG, Cable, Connector: IEC C13 | 4783 |
|--|------|

[Power Cord Overview complete](#)

| | |
|---|---------|
| VAC13KS, Overview, V-Lock cord retaining, diverse Connector IEC C13, diverse, black | VAC13KS |
| VAC17KS, V-Lock cord retaining, diverse m, Connector IEC C17, diverse, black / grey / white | VAC17KS |