

## 144 nA I<sub>Q</sub> Low Quiescent Current Buck DC/DC Converter for Energy Harvester

No. EA-414-200508

### OVERVIEW

R1800K is a power-storing buck DC/DC converter for a photovoltaic and vibration energy harvester. A low operating quiescent current allows a harvester to be used under a low-illumination environment, and it is suitable for an equipment with low power supplied from a harvester.

### KEY BENEFITS

- Providing a low operating quiescent current (I<sub>Q</sub> 144 nA) and a high efficiency (approximately 90% @ 10 μA).
- A Control function that enables a maximum power optimizes a power supply from an energy harvester.

### KEY SPECIFICATIONS

- Input Voltage Range: 2.0 V to 5.5 V
- Output Voltage Range: 2.0 V to 4.5 V
- Output Voltage Accuracy: ±3.0%
- Operating Quiescent Current:  
Typ. 144 nA (T<sub>a</sub> = 25°C, at no load)
- Starting Power: 720 nW
- Reverse Current Protection (V<sub>IN</sub> ≥ 2.0 V)
- Accuracy of Maximum Power Voltage: 200 mV

### APPLICATIONS

- Energy harvesting module of a photovoltaic and vibration energy harvester

### PACKAGE



**DFN(PLP)2730-12**  
2.7 mm x 3.0 mm x 0.6 mm

### SELECTION GUIDE

Product Name	Package	Quantity per Reel
R1800KxxxA-TR	DFN(PLP)2730-12	5,000 pcs

xxx: Select the ideal combination of the set output voltage (V<sub>SET</sub>) and the set maximum power voltage (V<sub>MPSET</sub>) from the code number starting from 002.

### TYPICAL CHARACTERISTICS

Efficiency vs. Output Current V<sub>SET</sub> = 3.3 V

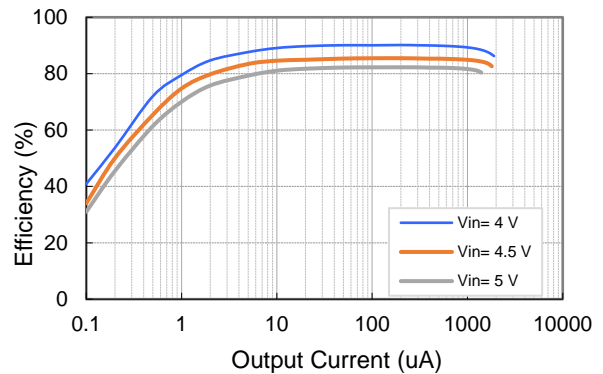

### TYPICAL APPLICATION

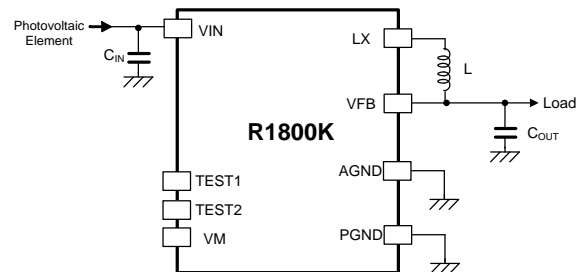

L = 22 μH, C<sub>IN</sub> = 10 μF, C<sub>OUT</sub> = 47 μF



## PIN DESCRIPTION

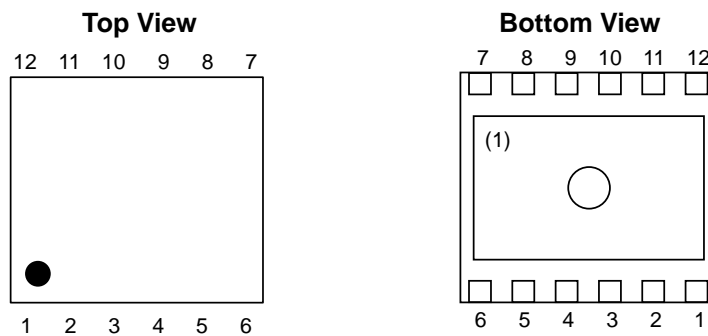

**DFN(PLP)2730-12 Pin Configuration**

### DFN(PLP)2730-12 Pin Description

Pin No.	Symbol	Description
1	AGND	AGND Pin
2	TEST1	Pin for Testing (Must not be connected)
3	TEST2	Pin for Testing (Must not be connected)
4	VM	Pin for Testing (Must not be connected)
5	NC	No Connection (Must not be connected)
6	NC	No Connection (Must not be connected)
7	VFB	Feedback Pin
8	PGND	PGND Pin
9, 10	LX	DC/DC Switching Pin
11, 12	VIN	Pin for Connecting Photovoltaic Element

<sup>(1)</sup> The tab on the bottom of the package enhances thermal performance and is electrically connected to GND (substrate level). It is recommended that the tab be connected to the ground plane on the board, or otherwise be left floating.

---

**R1800K**

---

No. EA-414-200508

**ABSOLUTE MAXIMUM RATINGS****Absolute Maximum Ratings**

(GND = 0 V)

Symbol	Parameter	Rating	Unit
$V_{IN}$	VIN Pin Voltage	-0.3 to 6.5	V
$V_{LX}$	LX Pin Voltage	-0.3 to $V_{IN} + 0.3$	V
$V_{VFB}$	VFB Pin Voltage	-0.3 to 6.5	V
$P_D$	Power Dissipation <sup>(1)</sup> [ DFN(PLP)2730-12, JEDEC STD. 51-7 Test Land Pattern ]	1850	mW
$T_j$	Junction Temperature Range	-40 to 85	°C
$T_{stg}$	Storage Temperature Range	-55 to 125	°C

**ABSOLUTE MAXIMUM RATINGS**

Electronic and mechanical stress momentarily exceeded absolute maximum ratings may cause permanent damage and may degrade the lifetime and safety for both device and system using the device in the field. The functional operation at or over these absolute maximum ratings is not assured.

**RECOMMENDED OPERATING CONDITIONS****Recommended Operating Conditions**

Symbol	Parameter	Rating	Unit
$V_{IN}$	Input Voltage	2.0 to 5.5	V
$T_a$	Operating Temperature Range	-40 to 85	°C

**RECOMMENDED OPERATING CONDITIONS**

All of electronic equipment should be designed that the mounted semiconductor devices operate within the recommended operating conditions. The semiconductor devices cannot operate normally over the recommended operating conditions, even if they are used over such conditions by momentary electronic noise or surge. And the semiconductor devices may receive serious damage when they continue to operate over the recommended operating conditions.

---

<sup>(1)</sup> Refer to *POWER DISSIPATION* for detailed information.

---

## ELECTRICAL CHARACTERISTICS

The specifications surrounded by  are guaranteed by design engineering at  $-40^{\circ}\text{C} \leq T_a \leq 85^{\circ}\text{C}$ .

### R1800K Electrical Characteristics

( $T_a = 25^{\circ}\text{C}$ )

Symbol	Parameter	Condition	Min.	Typ.	Max.	Unit
$V_{\text{OUT}}$	Output Voltage	$V_{\text{IN}} \geq V_{\text{SET}} + 0.5 \text{ V}$ , at no load	<span style="border: 1px solid black;">x 0.97</span>		<span style="border: 1px solid black;">x 1.03</span>	V
$I_{\text{Q}}$	Operating Quiescent Current	$V_{\text{IN}} = 5.0 \text{ V}$ , $V_{\text{SET}} = 3.0 \text{ V}$ , device not switching		144	<span style="border: 1px solid black;">300</span>	nA
$P_{\text{ST}}$	Minimum Starting Power	$T_a = 25^{\circ}\text{C}$ , $V_{\text{IN}} = 4 \text{ V}$ , $V_{\text{SET}} = 3.3 \text{ V}$ , when constant current is applied		720		nW
$V_{\text{MP}}$	Accuracy of Maximum Power Voltage				<span style="border: 1px solid black;">200</span>	mV
$I_{\text{REV}}$	Reverse Current	$V_{\text{IN}} \geq 2.0 \text{ V}$ , $V_{\text{FB}} = 4.5 \text{ V}$ (When $V_{\text{IN}}$ drops from 2.5 V or more) Charging current to $C_{\text{IN}}$ and $C_{\text{OUT}}$ are not included <sup>(1)</sup>		10	<span style="border: 1px solid black;">100</span>	nA

All test items listed under Electrical Characteristics are done under the pulse load condition ( $T_j \approx T_a = 25^{\circ}\text{C}$ ).  
Test circuit is operated with "Open Loop Control" ( $\text{GND} = 0 \text{ V}$ ), unless otherwise specified.

<sup>(1)</sup> Reverse current protection operates at  $V_{\text{IN}} \geq 2 \text{ V}$ . It does not function with the voltage under 2 V. Set as  $V_{\text{MPSET}} > V_{\text{SET}} + 0.5 \text{ V}$ . Due to having a hysteresis in the reverse current protection, a state may be detected as a reverse current even if  $V_{\text{IN}} = V_{\text{OUT}}$ .

---

**R1800K**

---

No. EA-414-200508

The specifications surrounded by  are guaranteed by design engineering at  $-40^{\circ}\text{C} \leq T_a \leq 85^{\circ}\text{C}$ .**Product-specific Electrical Characteristics**

Product Name	V <sub>OUT</sub> [V]			V <sub>MP</sub> [V]	
	Min.	Typ.	Max.	Typ.	Max.
R1800K002A	<span style="border: 1px solid black;">1.940</span>	2.0	<span style="border: 1px solid black;">2.060</span>	2.5	<span style="border: 1px solid black;">2.7</span>
R1800K003A	<span style="border: 1px solid black;">1.940</span>	2.0	<span style="border: 1px solid black;">2.060</span>	3.8	<span style="border: 1px solid black;">4.0</span>
R1800K004A	<span style="border: 1px solid black;">1.940</span>	2.0	<span style="border: 1px solid black;">2.060</span>	4.0	<span style="border: 1px solid black;">4.2</span>
R1800K005A	<span style="border: 1px solid black;">1.940</span>	2.0	<span style="border: 1px solid black;">2.060</span>	4.5	<span style="border: 1px solid black;">4.7</span>
R1800K006A	<span style="border: 1px solid black;">1.940</span>	2.0	<span style="border: 1px solid black;">2.060</span>	5.0	<span style="border: 1px solid black;">5.2</span>
R1800K008A	<span style="border: 1px solid black;">3.201</span>	3.3	<span style="border: 1px solid black;">3.399</span>	3.8	<span style="border: 1px solid black;">4.0</span>
R1800K009A	<span style="border: 1px solid black;">3.201</span>	3.3	<span style="border: 1px solid black;">3.399</span>	4.0	<span style="border: 1px solid black;">4.2</span>
R1800K010A	<span style="border: 1px solid black;">3.201</span>	3.3	<span style="border: 1px solid black;">3.399</span>	4.5	<span style="border: 1px solid black;">4.7</span>
R1800K011A	<span style="border: 1px solid black;">3.201</span>	3.3	<span style="border: 1px solid black;">3.399</span>	5.0	<span style="border: 1px solid black;">5.2</span>
R1800K014A	<span style="border: 1px solid black;">4.365</span>	4.5	<span style="border: 1px solid black;">4.635</span>	5.0	<span style="border: 1px solid black;">5.2</span>
R1800K016A	<span style="border: 1px solid black;">3.783</span>	3.9	<span style="border: 1px solid black;">4.017</span>	4.4	<span style="border: 1px solid black;">4.6</span>
R1800K019A	<span style="border: 1px solid black;">2.910</span>	3.0	<span style="border: 1px solid black;">3.090</span>	4.4	<span style="border: 1px solid black;">4.6</span>
R1800K020A	<span style="border: 1px solid black;">2.910</span>	3.0	<span style="border: 1px solid black;">3.090</span>	4.2	<span style="border: 1px solid black;">4.4</span>
R1800K021A	<span style="border: 1px solid black;">2.619</span>	2.7	<span style="border: 1px solid black;">2.781</span>	3.9	<span style="border: 1px solid black;">4.1</span>
R1800K022A	<span style="border: 1px solid black;">2.619</span>	2.7	<span style="border: 1px solid black;">2.781</span>	4.4	<span style="border: 1px solid black;">4.6</span>
R1800K023A	<span style="border: 1px solid black;">2.619</span>	2.7	<span style="border: 1px solid black;">2.781</span>	5.0	<span style="border: 1px solid black;">5.2</span>

## THEORY OF OPERATION

### MAXIMUM POWER CONTROL

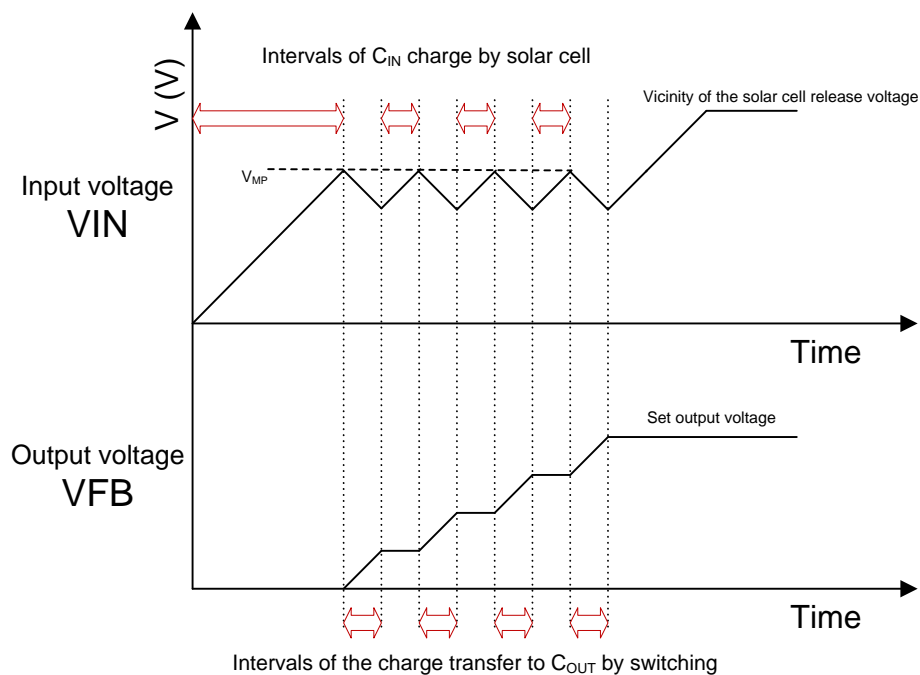

R1800K transfers power to a secondary side at the maximum power voltage ( $V_{MP}$ ), which is the operating point of the maximum amount of power generation of a solar cell. After R1800K receives power from the solar cell, the input voltage increases and when it reaches the  $V_{MP}$ , a switching starts and the R1800K transfers power to the secondary side. When a power transfer amount exceeds the supplied power from the solar cell, the input voltage decreases by the switching. At a certain point, the switching stops and a state changes to a charging mode. When the input voltage reaches the  $V_{MP}$  again, the R1800K transfers power to the secondary side. By repeating this operation enables transferring power to the secondary side while maintaining the operating point of the maximum amount of power generation of the solar cell.

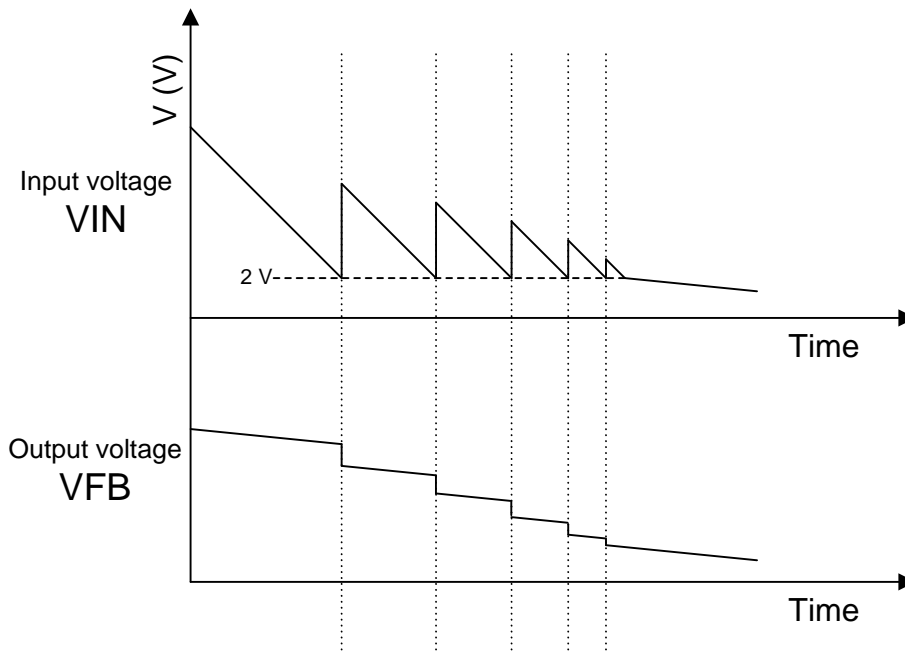
**REVERSE CURRENT DETECTION**

R1800K has a reverse current protection to maintain an electric charge of the output side when the light is cut off. When the light is cut off after a normal operation and a power supply from the solar cell is discontinued, the charge of supply current of a circuit connected respectively to the input and output sides is drawn. When the input voltage drops below the output voltage, the reverse current protection operates (at the backflow) and prevents the charge drawn from the output side. As shown in the figure above, this protection operates at 2 V or higher. When the input voltage drops below 2 V, the charge of the output side flows back to the input side. The drawn charge increases for a moment, but the R1800K returns to the reverse current protection state. The average amount of charge drawn from the output side is extremely minute.



## APPLICATION INFORMATION

### Typical Application Circuit

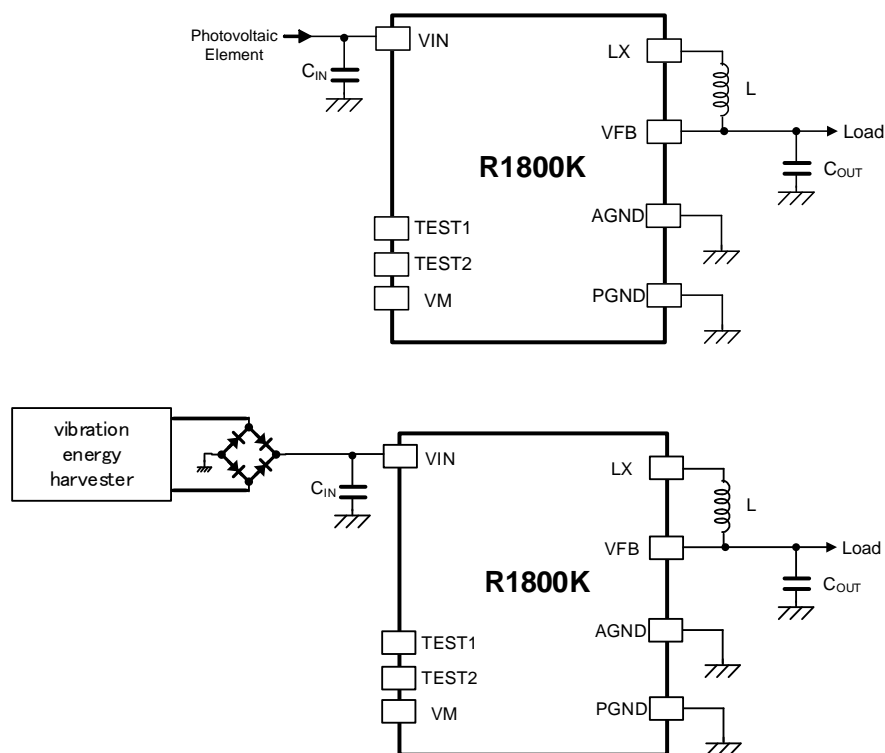

R1800K Typical Application Circuit

### Recommended External Components

Symbol	Descriptions	Parts Name
C <sub>IN</sub>	Ceramic Capacitor 10 μF or higher	C1608X5R1E106M080AC
C <sub>OUT</sub>	Ceramic Capacitor 47 μF or higher	C3216X6S1A476M160AC
	Large-capacity Electrical Storage Device	Refer below table
L	Inductor 22 μH	VLS201612CX-220M-1

### Recommended Large-capacity Electrical Storage Devices

Manufacturer	Series	Parts Name	Capacity	Type	Supplement
TDK	CeraCharge™	BCT1812M101AG	100μAh	All-solid-state Li-ion	CeraCharge™ is a trademark of TDK
NICHICON	SLB series	SLB03070LR35	350μAh	Li-ion	
NGK	EnerCera®	ET1210C-R ET2016C-R ET271704P-H	5mAh 25mAh 5mAh	Li-ion	EnerCera® is a trademark of NGK
Murata	CT series	CT04120	3mAh	Li-ion	

## TECHNICAL NOTES

The performance of a power source circuit using this device is highly dependent on a peripheral circuit. A peripheral component or the device mounted on PCB should not exceed a rated voltage, a rated current or a rated power. When designing a peripheral circuit, please be fully aware of the following points.

- External components must be connected as close as possible to the IC and make wiring as short as possible. Especially, the capacitor connected in between  $V_{IN}$  pin and GND pin must be wiring the shortest.
- If their impedance is high, internal voltage of the IC may shift by the switching current, and the operating may be unstable. Make the power supply and GND lines sufficient.
- As for wirings of the power, the ground, the inductor, the LX and the VFB pins, due consideration must be given to large current occurred by switching.
- Using a ceramic capacitor with a lower equivalent series resistance (ESR) is recommended; a capacitor of 10 $\mu$ F or higher for  $C_{IN}$  between  $V_{IN}$  and GND pins, a capacitor of 47 $\mu$ F or higher for  $C_{OUT}$ . Using a mass-storage device for  $C_{OUT}$  also is recommended. Please choose capacitors depending on the bias characteristics,  $V_{IN}$  and  $V_{OUT}$ . (Refer to *Recommended External Components*)
- Please choose inductors which have low direct-current resistance, enough allowable current and low magnetic saturation. Current-limited circuit may operate with LX peak current before reaching expected load current in case of low allowable current and extremely low inductance value under load condition.
- Note that the current-limited circuit is self-heating and radiation environment sensitive.

- **PCB Layout**

R1800KxxxA-TR (PKG:DFN(PLP)2730-12)

Top Layer

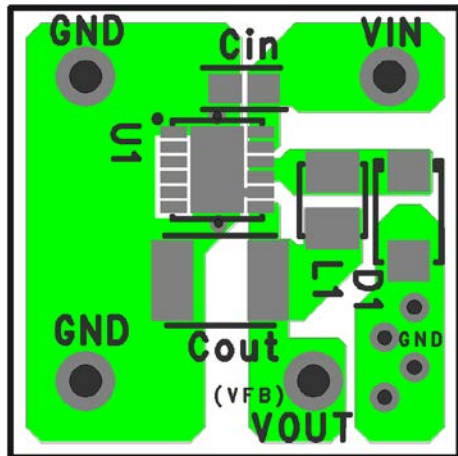

Bottom Layer

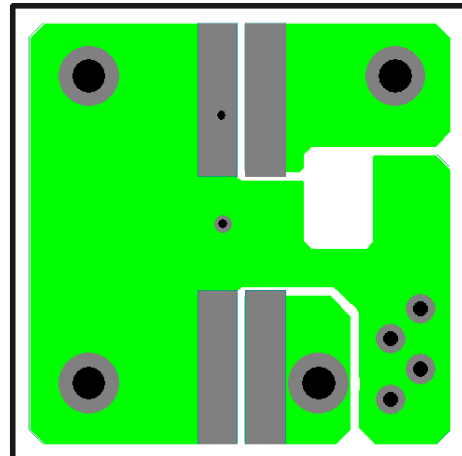

**TYPICAL CHARACTERISTICS**

Note: Typical Characteristics are intended to be used as reference data; they are not guaranteed.

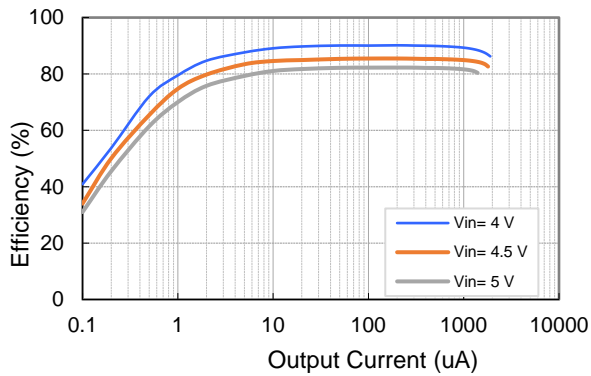
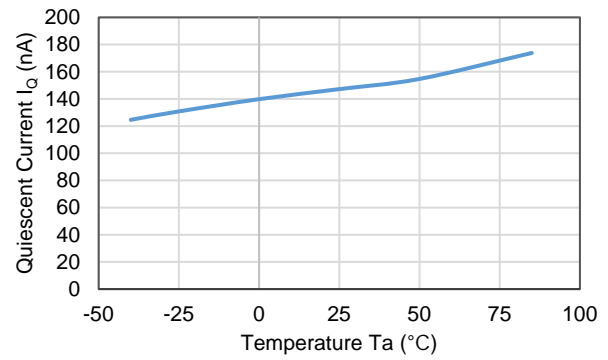
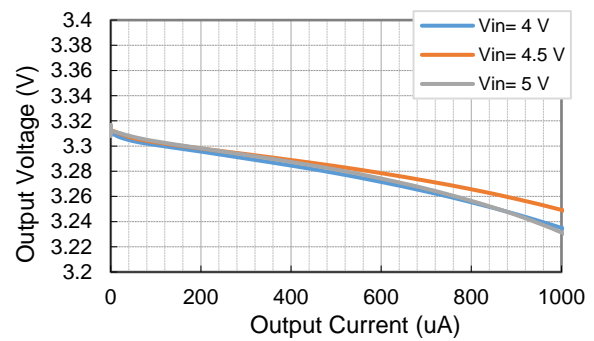
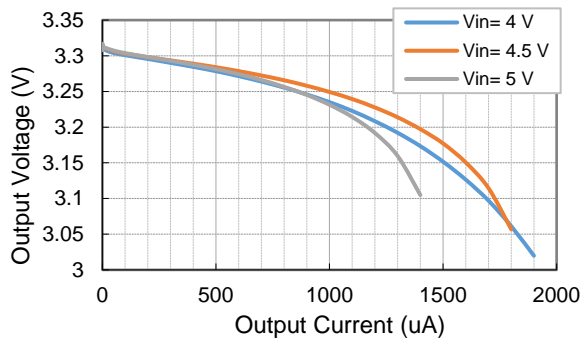
**1) Efficiency vs. Output Current**  $V_{SET} = 3.3\text{ V}$ **2) Quiescent Current vs. Temperature****3) Output Voltage vs. Output Current**

The power dissipation of the package is dependent on PCB material, layout, and environmental conditions. The following measurement conditions are based on JEDEC STD. 51-7.

**Measurement Conditions**

Item	Measurement Conditions
Environment	Mounting on Board (Wind Velocity = 0 m/s)
Board Material	Glass Cloth Epoxy Plastic (Four-Layer Board)
Board Dimensions	76.2 mm × 114.3 mm × 0.8 mm
Copper Ratio	Outer Layer (First Layer): Less than 95% of 50 mm Square Inner Layers (Second and Third Layers): Approx. 100% of 50 mm Square Outer Layer (Fourth Layer): Approx. 100% of 50 mm Square
Through-holes	φ 0.3 mm × 23 pcs

**Measurement Result**

(Ta = 25°C, Tjmax = 85°C)

Item	Measurement Result
Power Dissipation	1850 mW
Thermal Resistance (θja)	θja = 32°C/W
Thermal Characterization Parameter (ψjt)	ψjt = 8°C/W

θja: Junction-to-Ambient Thermal Resistance

ψjt: Junction-to-Top Thermal Characterization Parameter

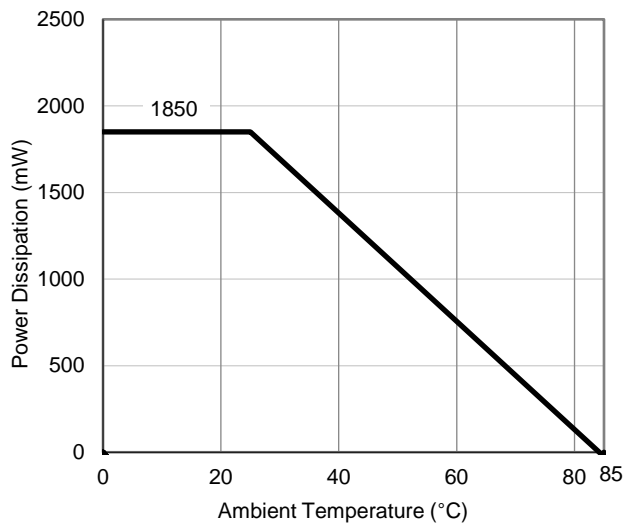

**Power Dissipation vs. Ambient Temperature**

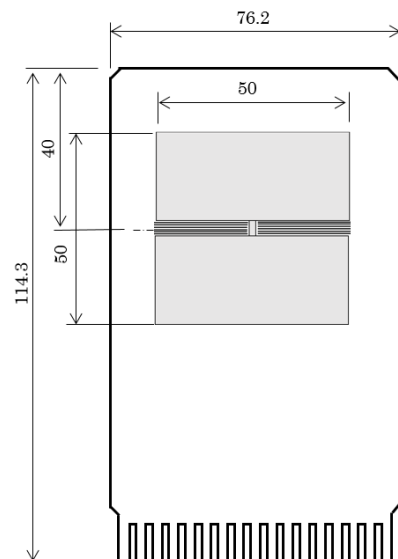

**Measurement Board Pattern**

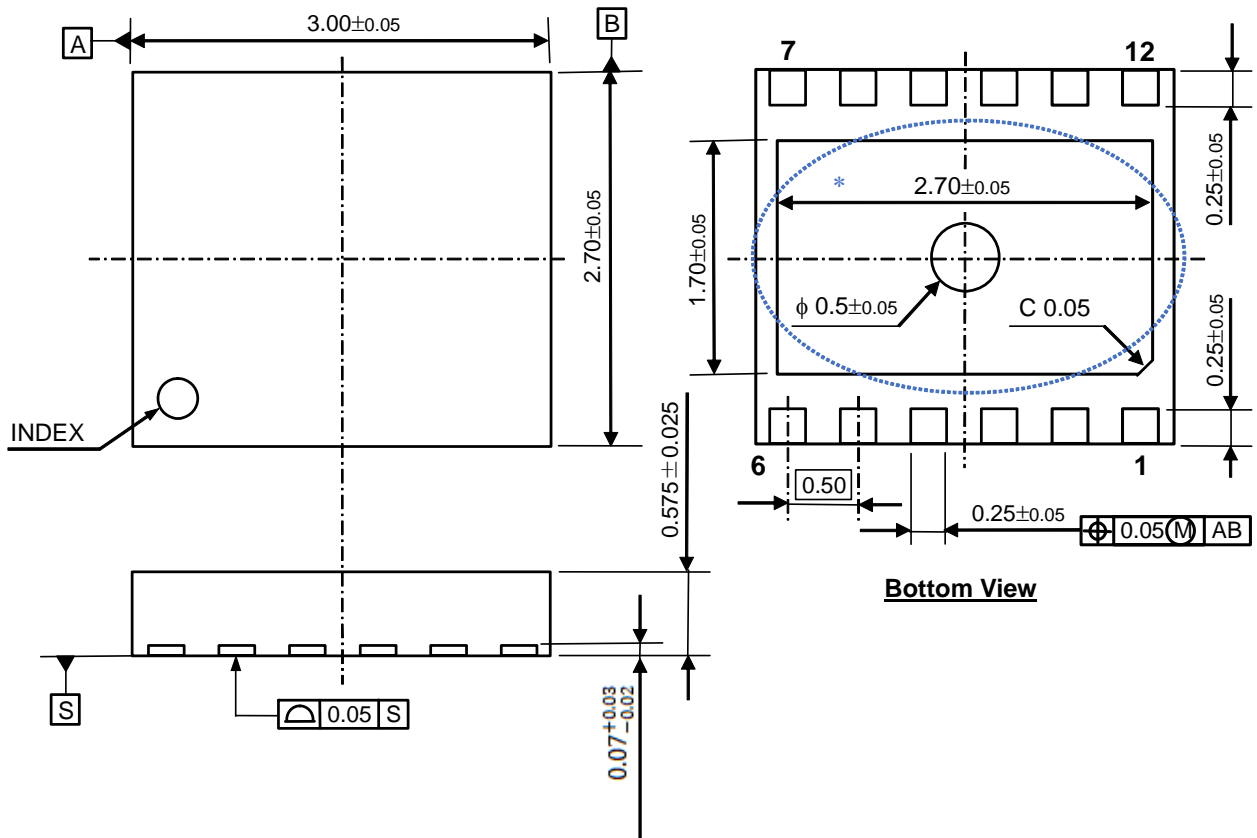

DFN(PLP)2730-12 Package Dimensions (Unit: mm)

\*The tab on the bottom of the package shown by blue circle is a substrate potential (GND). It is recommended that this tab be connected to the ground plane on the board but it is possible to leave the tab floating.



1. The products and the product specifications described in this document are subject to change or discontinuation of production without notice for reasons such as improvement. Therefore, before deciding to use the products, please refer to our sales representatives for the latest information thereon.
2. The materials in this document may not be copied or otherwise reproduced in whole or in part without prior written consent of our company.
3. Please be sure to take any necessary formalities under relevant laws or regulations before exporting or otherwise taking out of your country the products or the technical information described herein.
4. The technical information described in this document shows typical characteristics of and example application circuits for the products. The release of such information is not to be construed as a warranty of or a grant of license under our company's or any third party's intellectual property rights or any other rights.
5. The products listed in this document are intended and designed for use as general electronic components in standard applications (office equipment, telecommunication equipment, measuring instruments, consumer electronic products, amusement equipment etc.). Those customers intending to use a product in an application requiring extreme quality and reliability, for example, in a highly specific application where the failure or misoperation of the product could result in human injury or death (aircraft, spacevehicle, nuclear reactor control system, traffic control system, automotive and transportation equipment, combustion equipment, safety devices, life support system etc.) should first contact us.
6. We are making our continuous effort to improve the quality and reliability of our products, but semiconductor products are likely to fail with certain probability. In order to prevent any injury to persons or damages to property resulting from such failure, customers should be careful enough to incorporate safety measures in their design, such as redundancy feature, fire containment feature and fail-safe feature. We do not assume any liability or responsibility for any loss or damage arising from misuse or inappropriate use of the products.
7. Anti-radiation design is not implemented in the products described in this document.
8. The X-ray exposure can influence functions and characteristics of the products. Confirm the product functions and characteristics in the evaluation stage.
9. WLCSP products should be used in light shielded environments. The light exposure can influence functions and characteristics of the products under operation or storage.
10. There can be variation in the marking when different AOI (Automated Optical Inspection) equipment is used. In the case of recognizing the marking characteristic with AOI, please contact our sales or our distributor before attempting to use AOI.
11. Please contact our sales representatives should you have any questions or comments concerning the products or the technical information.



**Nisshinbo Micro Devices Inc.**

**Official website**

<https://www.nisshinbo-microdevices.co.jp/en/>

**Purchase information**

<https://www.nisshinbo-microdevices.co.jp/en/buy/>

