

Automotive Ethernet

Common Mode Choke for 100Base-T1

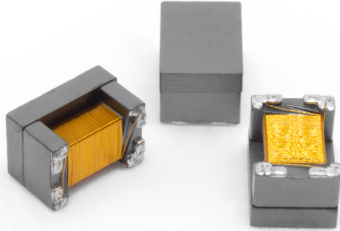

- Ⓢ Meet IEEE802.3bw and OA TC1 v2.0 Requirements
- Ⓢ Meets AEC-Q200 Requirement
- Ⓢ PPAP Documentation Support
- Ⓢ Approved by Major Automotive OEMs and PHY Partners
- Ⓢ Operating Temperature: - 40°C to +125°C
- Ⓢ Factory IATF-16949 Certified
- Ⓢ Patented Technology
- Ⓢ Open Alliance TC1 Test Report Available

Electrical Specifications 25°C

Part Number	Insertion Loss (dB MAX)			Return Loss (dB MIN)			Common Mode Rejection (dB MIN)			Differential to Common Mode Rejection (dB MIN)			
	1-60MHz			1-10MHz	30MHz	60MHz	1MHz	10-100MHz	40MHz	1000MHz	1-10 MHz	100 MHz	1000 MHz
AE2002	-1			-26	-21.1	-18	-23	-42	-25	-15	-70	-50	-24

Part Number	Insertion Loss (dB MAX)			Return Loss (dB MIN)			Common Mode Rejection (dB MIN)			Differential to Common Mode Rejection (dB MIN)		
	1-10MHz	33MHz	66MHz	1-10MHz	33MHz	66MHz	1MHz	10-80MHz	200MHz	1-10 MHz	100 MHz	200 MHz
AE0100	-0.5	-0.7	-1	-27	-22	-19	-25	-45	-37	-70	-50	-40

Notes:

- DCR per winding is 5.0mOHms for AE2002 and 3.5mOhms for AE0100
- I_{max} for both parts is 100mA
- Voltage rating for both parts is 60V Max

Mechanical

AE2002

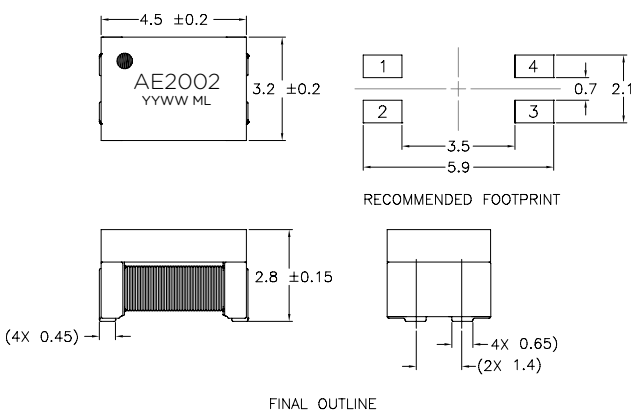

AE0100

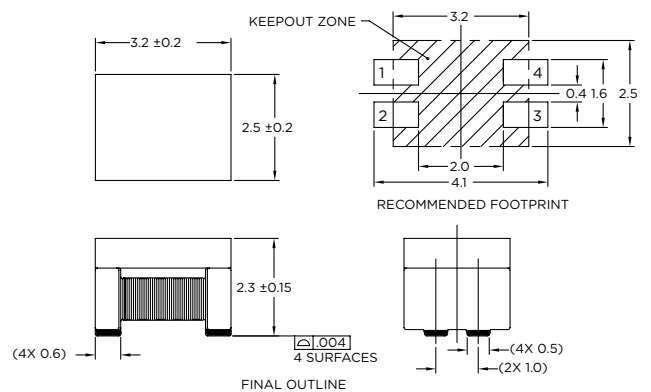

Schematic

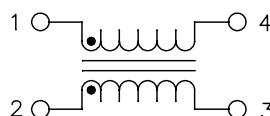

Dimensions: Inches (mm)
Unless otherwise specified, all tolerances are ± .010 (0.25)

Impedance Plot

AE2002

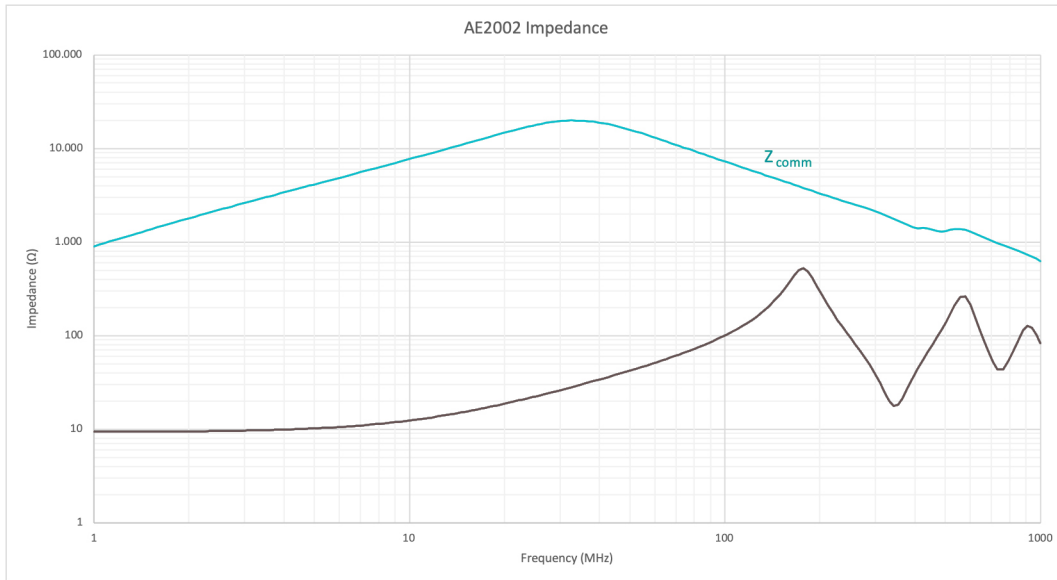

AE0100

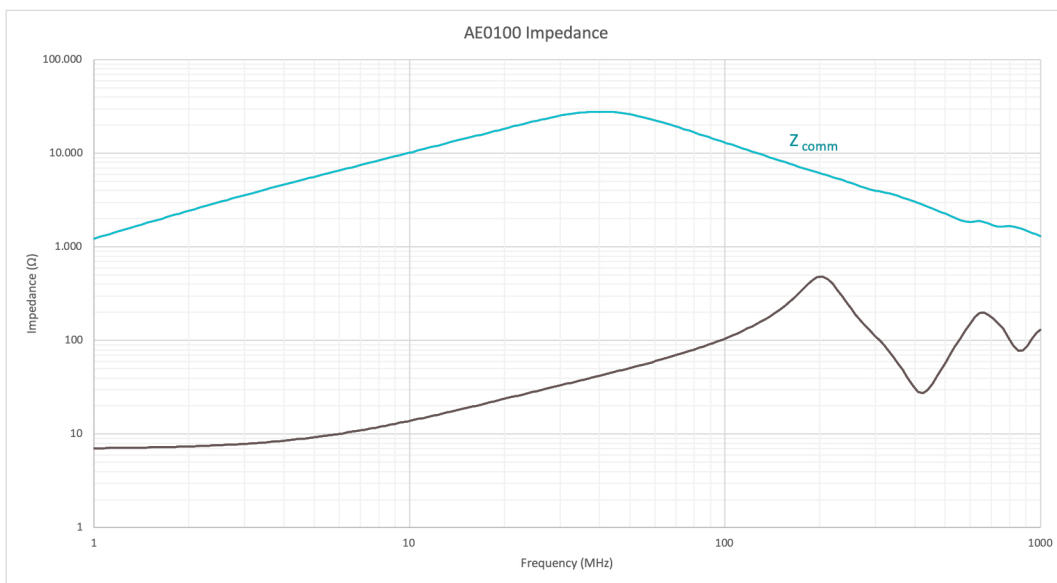

Automotive Ethernet

Common Mode Choke for 100Base-T1

Tape & Reel

AE2002 / AE0100

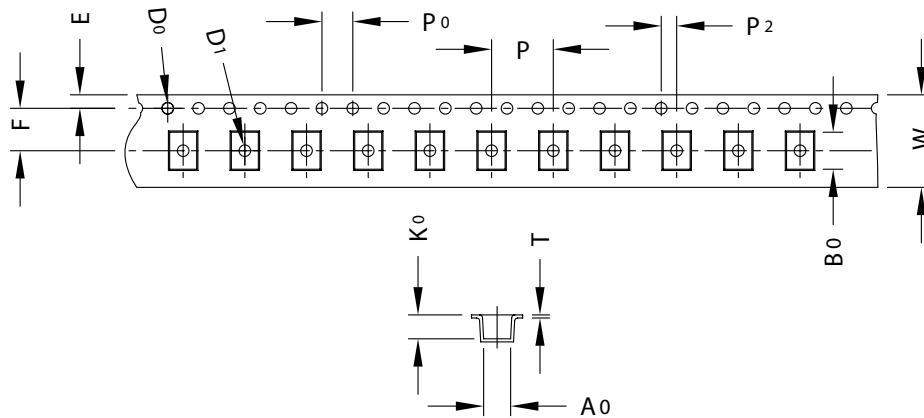

Dim Chart

Item	Quantity/ Reel	W	A ₀	B ₀	K ₀	P	F	E	D ₀	D ₁	P ₀	P ₂	T
AE2002	2500	12.00 ±0.30	3.5 ±0.10	4.8 ±0.10	3.1 ±0.10	8.00 ±0.10	5.50 ±0.10	1.75 ±0.10	1.50 ^{+0.10} _{-0.00}	1.50 ^{+0.10} _{-0.00}	4.00 ±0.10	2.00 ±0.10	0.40 ±0.05
AE0100	3000	12.00 ±0.30	2.7 ±0.10	3.5 ±0.10	2.6 ±0.10	4.00 ±0.10	5.50 ±0.10	1.75 ±0.10	1.50 ^{+0.10} _{-0.00}	1.50 ^{+0.10} _{-0.00}	4.00 ±0.10	2.00 ±0.10	0.40 ±0.05

For More Information:

Americas - prodinfornetworkamericas@pulseelectronics.com | Europe - comms-apps-europe@pulseelectronics.com | Asia - prodinfornetworkapac@pulseelectronics.com

Performance warranty of products offered on this data sheet is limited to the parameters specified. Data is subject to change without notice. Other brand and product names mentioned herein may be trademarks or registered trademarks of their respective owners. © Copyright, 2021. Pulse Electronics, Inc. All rights reserved.