

- 925 MHz Low-loss SAW Filter
- Optimized for use with the TRC103 Transceiver
- Balanced 150 ohm IC Interface
- Complies with Directive 2002/95/EC (RoHS)
- Moisture Sensitivity Level: 1
- AEC-Q200 Qualified

RF3620E

**925.0 MHz
 SAW Filter**

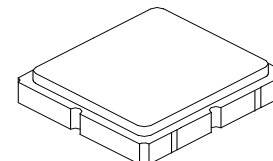

SM3030-8

Absolute Maximum Ratings

Rating	Value	Units
Input Power Level	+15	dBm
DC Voltage	±5	V
Operating Temperature Range	-40 to +85	°C
Storage Temperature Range in Tape and Reel	-40 to +85	°C

Electrical Characteristics

Characteristic	Sym	Notes	Min	Typ	Max	Units
Center Frequency	f_c			925.0		MHz
1 dB Bandwidth	BW_1			12	16	MHz
Maximum Insertion Loss, 920.0 to 930.0 MHz	IL_{MAX}			2.3	3.0	dB
Amplitude Ripple, p-p, 922.0 to 928.0 MHz				0.5	1.0	
Rejection Referenced to Insertion Loss at 925.0 MHz:						
300 to 810 MHz			36	41		
810 to 895 MHz			46	51		
1000 to 1265 MHz			47	52		
1265 to 2000 MHz			34.5	40		
2000 to 2500 MHz			30	35		
2500 to 3000 MHz			30	35		
Source Impedance	Z_S			50		Ω
Load Impedance	Z_L			150		Ω

Case Style	SM3030-8 3.0 x 3.0 mm Nominal Footprint		
Lid Symbolization (Y=year, WW=week, S=shift) dot=pin 1 indicator	A31, YWWS		
Standard Reel Quantity	Reel Size 7 Inch	500 Pieces/Reel	
	Reel Size 13 Inch	3000 Pieces/Reel	

Electrical Connections

Connection	Terminals
Single-ended Port	6
Balanced Port	1, 3
Case Ground	4, 5, 7, 8
No Connection	2

CAUTION: Electrostatic Sensitive Device. Observe precautions for handling.

NOTES:

1. The design, manufacturing process, and specifications of this device are subject to change.
2. US or International patents may apply.
3. RoHS compliant from the first date of manufacture.

RF3620E - TRC103 Application Circuit

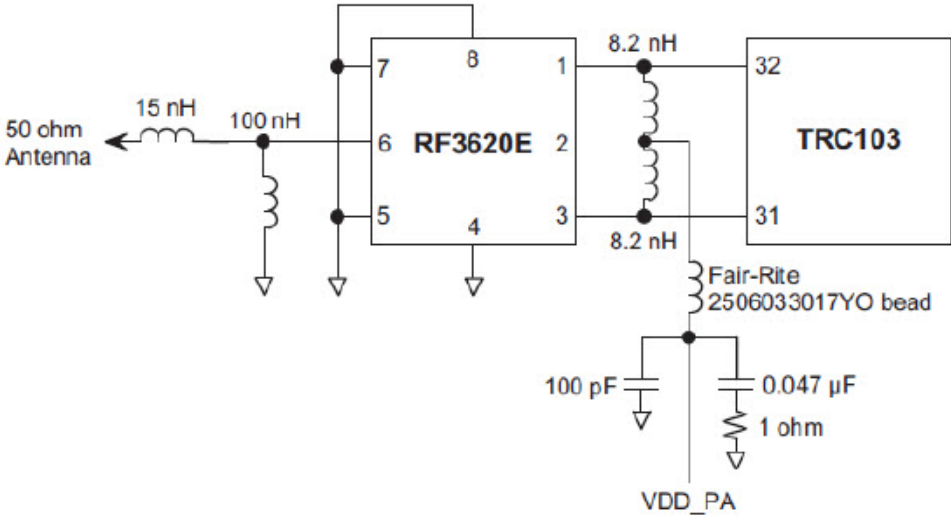

RF3620E Passband Response

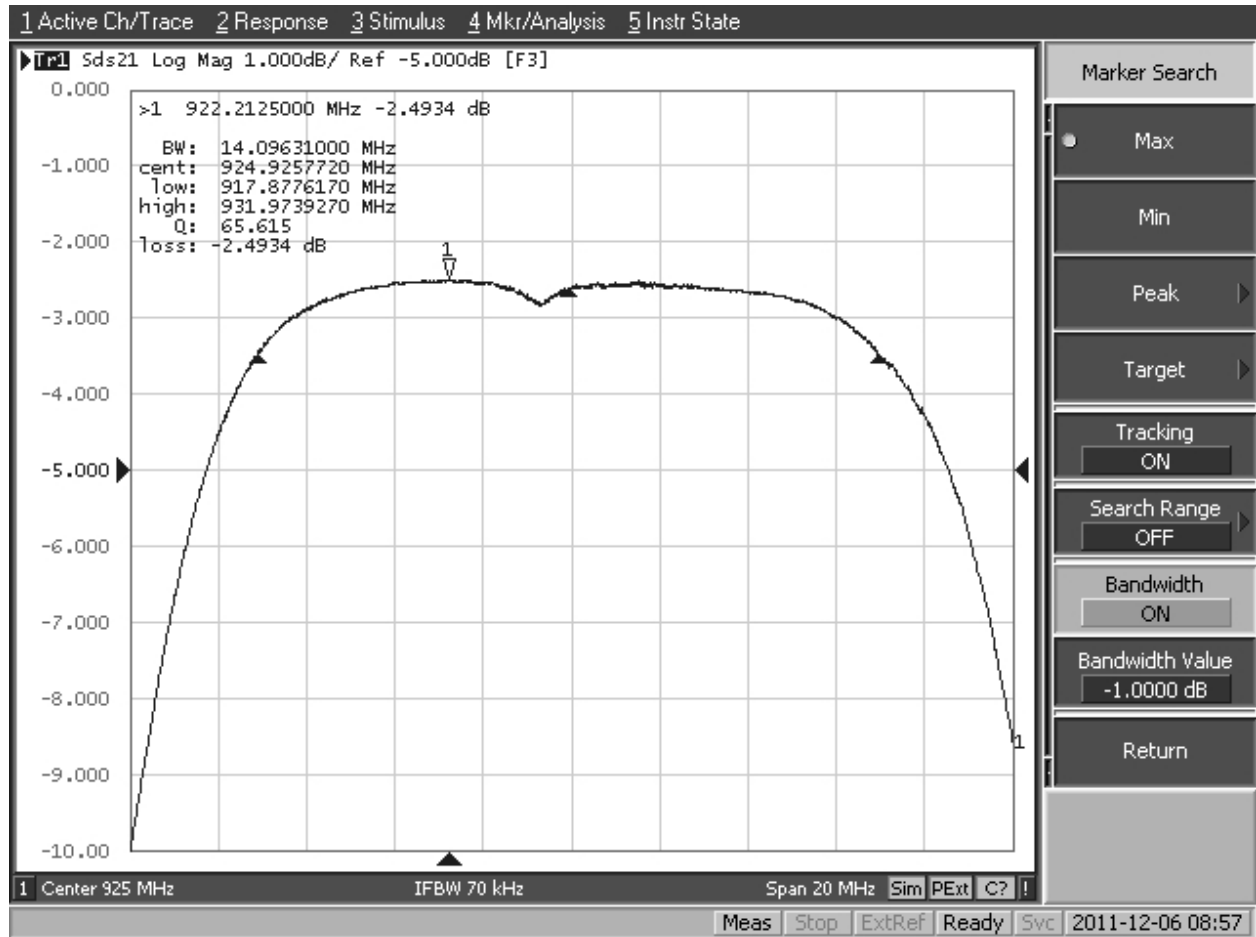

RF3620E Response, 875 to 975 MHz

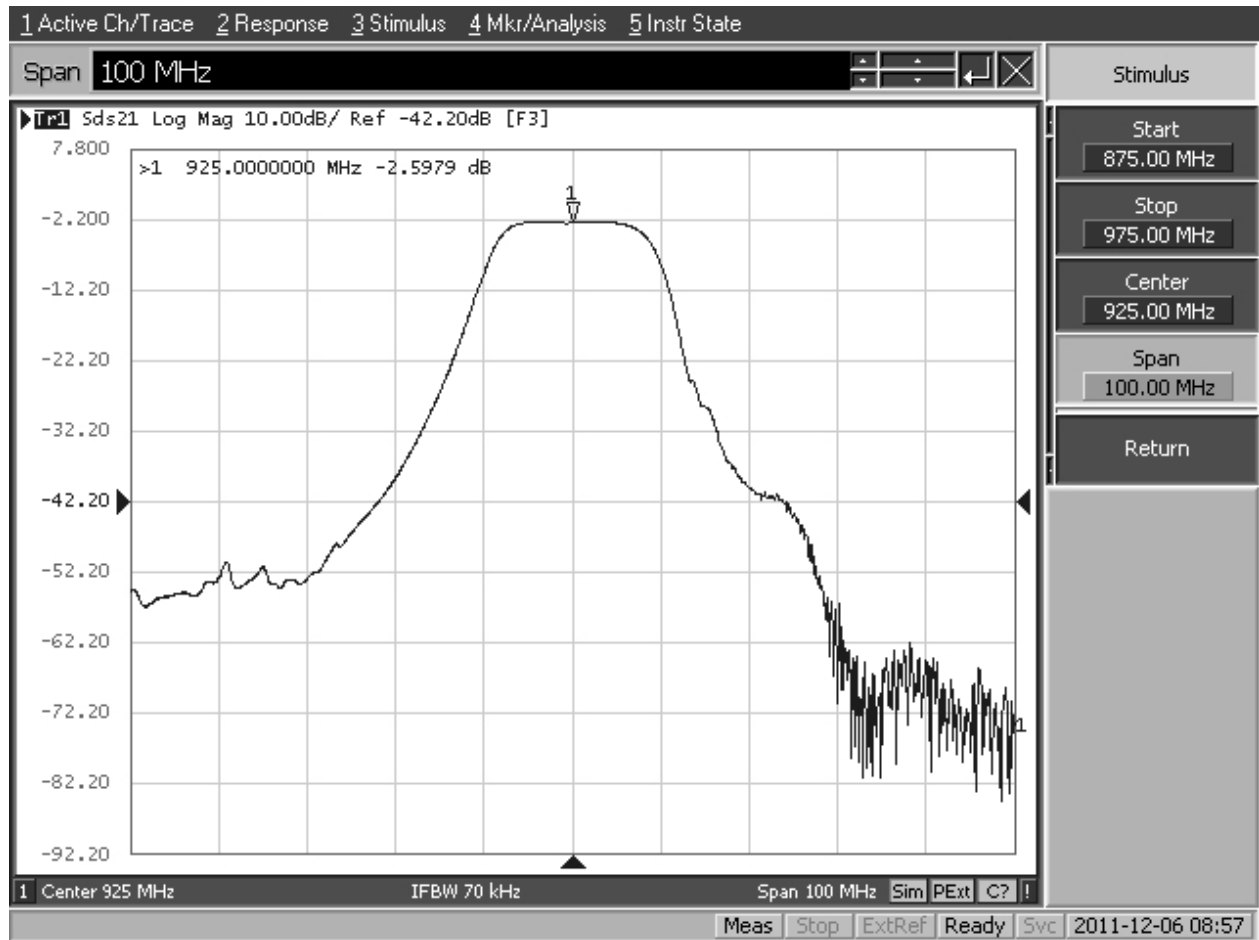

RF3620E Broadband Response

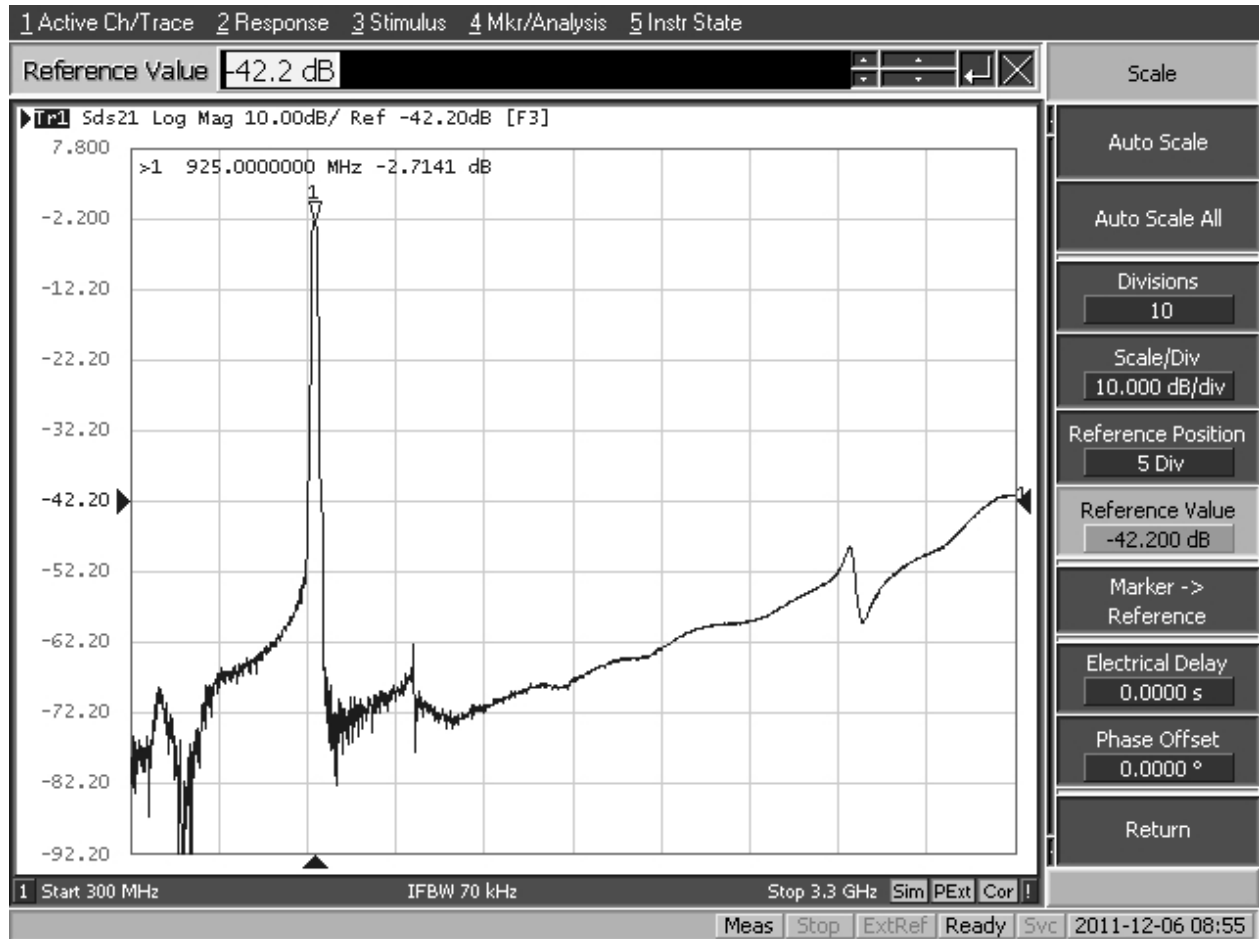

RF3620E Impedance Plots

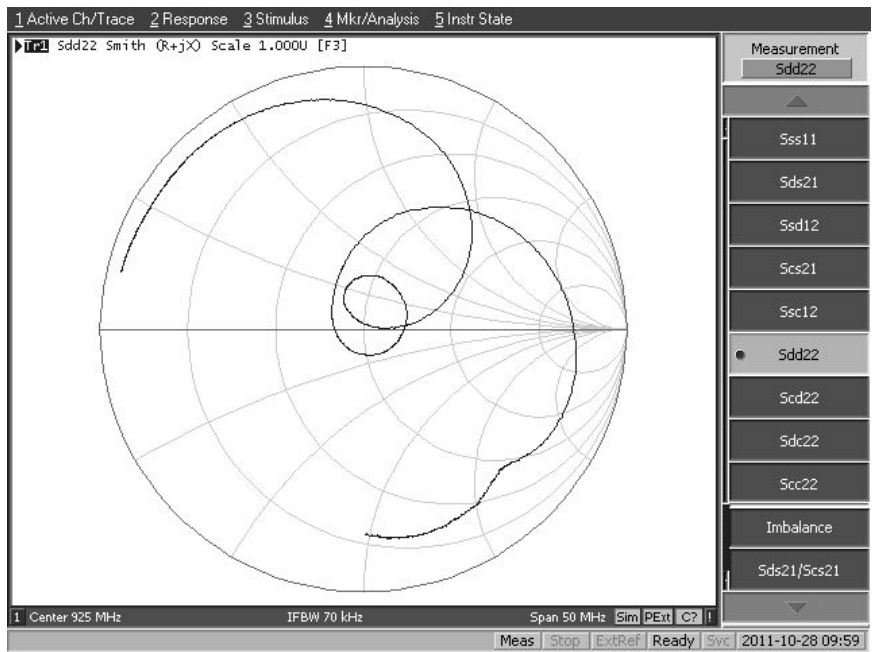
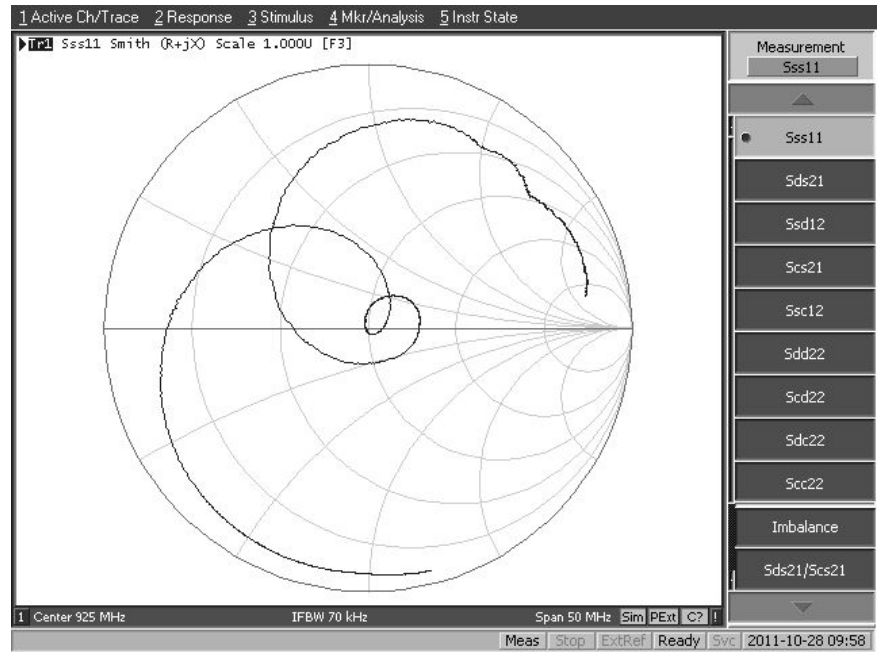

8-Terminal Ceramic Surface-Mount Case 3.0 X 3.0 mm Nominal Footprint

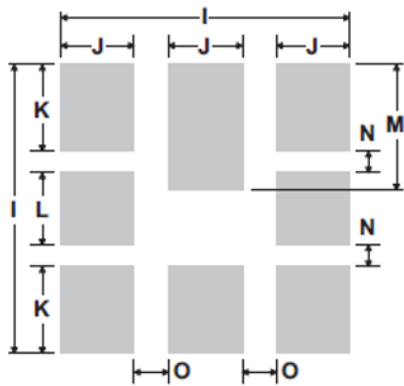
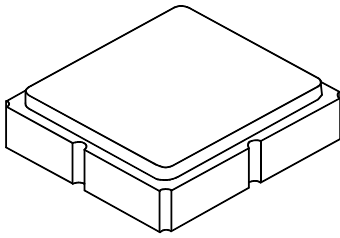

PCB Footprint Top View

Case and PCB Footprint Dimensions

Dimension	mm			Inches		
	Min	Nom	Max	Min	Nom	Max
A	2.87	3.0	3.13	0.113	0.118	0.123
B	2.87	3.0	3.13	0.113	0.118	0.123
C	1.14	1.27	1.40	0.045	0.050	0.055
D	0.79	0.92	1.05	0.031	0.036	0.041
E	0.62	0.75	0.88	0.024	0.029	0.034
F	0.47	0.60	0.73	0.018	0.024	0.029
G	0.47	0.60	0.73	0.018	0.024	0.029
H	1.07	1.20	1.33	0.042	0.047	0.052
I		3.19			0.126	
J		0.81			0.032	
K		0.96			0.038	
L		0.81			0.032	
M		1.39			0.055	
N		0.23			0.009	
O		0.38			0.015	

Case Materials

Materials	
Solder Pad Plating	0.3 to 1.0 μm Gold over 1.27 to 8.89 μm Nickel
Lid Plating	2.0 to 3.0 μm Nickel
Body	Al_2O_3 Ceramic

TOP VIEW

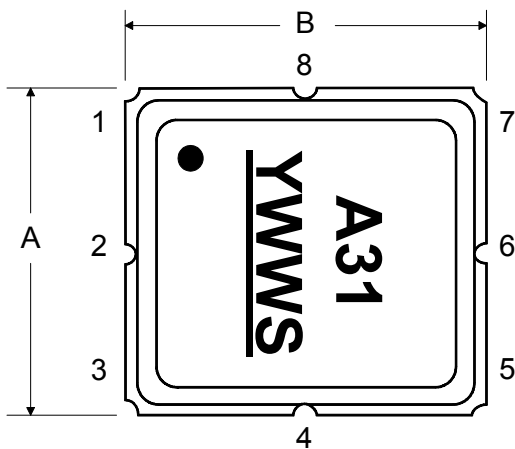

BOTTOM VIEW

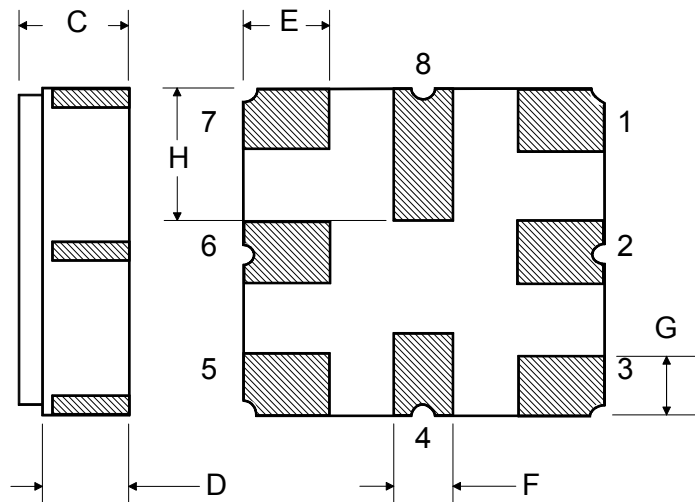

Recommended Reflow Profile

1. Preheating shall be fixed at 150~180°C for 60~90 seconds.
2. Ascending time to preheating temperature 150°C shall be 30 seconds min.
3. Heating shall be fixed at 220°C for 50~80 seconds and at 260°C +0/-5°C peak (10 seconds).
4. Time: 5 times maximum.

