

Self Protected High Side Driver with Temperature Shutdown and Current Limit

NCV8460A

The NCV8460A is a fully protected High-Side driver that can be used to switch a wide variety of loads, such as bulbs, solenoids and other actuators. The device is internally protected from an overload condition by an active current limit and thermal shutdown.

A diagnostic output reports ON and OFF state open load conditions as well as thermal shutdown.

Features

- Short Circuit Protection
- Thermal Shutdown with Automatic Restart
- CMOS compatible control input
- Open Load Detection in On and Off State
- Diagnostic Output
- Undervoltage and Overvoltage Shutdown
- Loss of Ground Protection
- ESD protection
- Slew Rate Control for Low EMI Switching
- Very Low Standby Current
- NCV Prefix for Automotive and Other Applications Requiring Unique Site and Control Change Requirements; AEC Qualified and PPAP Capable
- These Devices are Pb-Free and are RoHS Compliant

Typical Applications

- Switch a Variety of Resistive, Inductive and Capacitive Loads
- Can Replace Electromechanical Relays and Discrete Circuits
- Automotive / Industrial

PRODUCT SUMMARY

Parameter	Symbol	Value	Units
Operating Voltage Range	V_S	6 to 36	V
$R_{DSon(max)}$ $T_J = 25^\circ\text{C}$	R_{ON}	60	m Ω
Output Current Limit (min)	I_{lim}	6	A

MARKING DIAGRAM



V8460A = Specific Device Code
A = Assembly Location
L = Wafer Lot
Y = Year
W = Work Week
▪ = Pb-Free Package

PIN CONNECTIONS

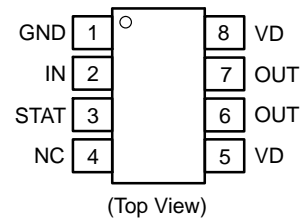

ORDERING INFORMATION

Device	Package	Shipping†
NCV8460ADR2G	SOIC-8 (Pb-Free)	2500 / Tape & Reel

†For information on tape and reel specifications, including part orientation and tape sizes, please refer to our Tape and Reel Packaging Specifications Brochure, BRD8011/D.

NCV8460A

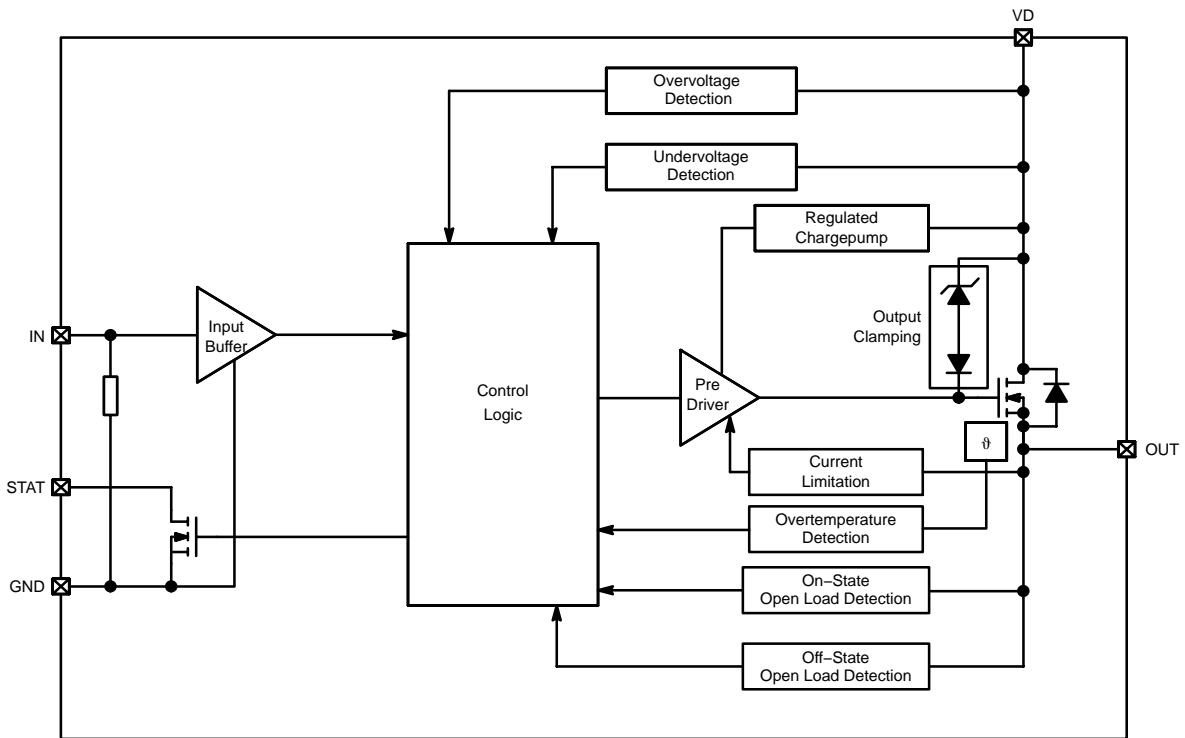

Figure 1. Block Diagram

PIN DESCRIPTION

Pin #	Symbol	Description
1	GND	Ground
2	IN	Logic Level Input
3	STAT	Status Output
4	N/C	No Connection
5	V _D	Supply Voltage
6	OUT	Output
7	OUT	Output
8	V _D	Supply Voltage

NCV8460A

MAXIMUM RATINGS

Rating	Symbol	Value		Unit
		Min	Max	
DC Supply Voltage	V_D	-0.3	41	V
Peak Transient Input Voltage (Load Dump 42.5 V, $V_D = 13.5$ V, $R_{LOAD} = 6.5$ Ω , ISO7637-2 pulse 5)	V_{peak}		56	V
Input Voltage	V_{in}	-8	8	V
Input Current	I_{in}	-5	5	mA
Output Current (Note 1)	I_{out}	-6	Internally Limited	A
Negative Ground Current	$-I_{gnd}$	-200	-	mA
Status Current	I_{status}	-5	5	mA
Power Dissipation, $T_A = 25^\circ\text{C}$	P_{tot}	1.183		W
Electrostatic Discharge (HBM Model 100 pF / 1500 Ω)				DC
Input		4		kV
Status		3.5		kV
Output		5		kV
V_D		5		kV
Single Pulse Inductive Load Switching Energy (Note 2) ($L = 1.8$ mH, $V_{bat} = 13.5$ V; $I_L = 9$ A, $T_{Jstart} = 150^\circ\text{C}$)	E_{AS}	100		mJ
Operating Junction Temperature	T_J	-40	+150	$^\circ\text{C}$
Storage Temperature	$T_{storage}$	-55	+150	$^\circ\text{C}$

Stresses exceeding those listed in the Maximum Ratings table may damage the device. If any of these limits are exceeded, device functionality should not be assumed, damage may occur and reliability may be affected.

1. Reverse Output current has to be limited by the load to stay within absolute maximum ratings and thermal performance.
2. Not subjected to production testing.

THERMAL RESISTANCE RATINGS

Parameter	Symbol	Max Value	Unit
Thermal Resistance Junction-to-Lead	$R_{\theta JL}$	30	$^\circ\text{C/W}$
Junction-to-Ambient (min. Pad)	$R_{\theta JA}$	110.8	$^\circ\text{C/W}$
Junction-to-Ambient (1" square pad size, FR-4, 1 oz Cu)	$R_{\theta JA}$	105.6	$^\circ\text{C/W}$

NCV8460A

ELECTRICAL CHARACTERISTICS ($8 \leq V_D \leq 36$ V; $-40^\circ\text{C} < T_J < 150^\circ\text{C}$ unless otherwise specified)

Rating	Symbol	Conditions	Value			Unit
			Min	Typ	Max	
Operating Supply Voltage	V_D		6	–	36	V
Undervoltage Shutdown	V_{UV}		3	5	6	V
Undervoltage	V_{UV_Rst}				6.5	V
Overvoltage Shutdown	V_{OV}		36			V
On Resistance	R_{ON}	$I_{out} = 2$ A; $T_J = 25^\circ\text{C}$, $V_D > 8$ V $I_{out} = 2$ A, $V_D > 8$ V			60 120	m Ω
Standby Current	I_D	Off State, $V_{in} = V_{out} = 0$ V, $V_D = 13.5$ V On State; $V_{in} = 5$ V, $V_D = 13.5$ V, $I_{out} = 0$ A		10 1.5	20 3.5	μ A mA
Output Leakage Current	I_L	$V_{in} = V_{out} = 0$ V $V_{in} = 0$ V, $V_{out} = 3.5$ V $V_{in} = V_{out} = 0$ V, $V_D = 13.5$ V	-20		50 10 3	μ A

INPUT CHARACTERISTICS

Input Voltage – Low	V_{in_low}				1.25	V
Input Current – Low	I_{in_low}	$V_{in} = 1.25$ V	1			μ A
Input Voltage – High	V_{in_high}		3.25			V
Input Current – High	I_{in_high}	$V_{in} = 3.25$ V			10	μ A
Input Hysteresis Voltage	V_{hyst}		0.25			V
Input Clamp Voltage	V_{in_cl}	$I_{in} = 1$ mA $I_{in} = -1$ mA	11 -13	12 -12	13 -11	V

SWITCHING CHARACTERISTICS

Turn-On Delay Time	t_{d_on}	to 10% V_{out} , $V_D = 13.5$ V, $R_L = 6.5$ Ω		40		μ s
Turn-Off Delay Time	t_{d_off}	to 90% V_{out} , $V_D = 13.5$ V, $R_L = 6.5$ Ω		30		μ s
Slew Rate On	dV_{out} / dt_{on}	10% to 80% V_{out} , $V_D = 13.5$ V, $R_L = 6.5$ Ω		0.9		V / μ s
Slew Rate Off	dV_{out} / dt_{off}	90% to 10% V_{out} , $V_D = 13.5$ V, $R_L = 6.5$ Ω		0.7		V / μ s

OUTPUT DIODE CHARACTERISTICS (Note 3)

Forward Voltage	V_F	$I_{out} = -1.3$ A, $T_J = 150^\circ\text{C}$			0.6	V
-----------------	-------	---	--	--	-----	---

STATUS PIN CHARACTERISTICS

Status Output Voltage Low	V_{stat_low}	$I_{stat} = 1.6$ mA		0.2	0.5	V
Status Leakage Current	$I_{stat_leakage}$	$V_{stat} = 5$ V		1	10	μ A
Status Pin Input Capacitance	C_{stat}	$V_{stat} = 5$ V (Note 3)			100	pF
Status Clamp Voltage	V_{stat_cl}	$I_{stat} = 1$ mA $I_{stat} = -1$ mA	10 -2.2	11 -1.2	12 -0.6	V

PROTECTION FUNCTIONS (Note 4)

Temperature Shutdown (Note 3)	T_{SD}		150	175	200	$^\circ\text{C}$
Temperature Shutdown Hysteresis (Note 3)	T_{SD_hyst}		7	15		$^\circ\text{C}$
Output Current Limit	I_{lim}	8 V $< V_D < 36$ V	6	9	15	A
		6 V $< V_D < 36$ V			15	A
Status Delay in Overload	t_{d_stat}				20	μ s
Switch Off Output Clamp Voltage	V_{clamp}	$I_{out} = 2$ A, $V_{in} = 0$ V, $L = 6$ mH	$V_D - 41$	$V_D - 45$	$V_D - 55$	V

3. Not subjected to production testing

4. To ensure long term reliability under heavy overload or short circuit conditions, protection and related diagnostic signals must be used together with a proper hardware/software strategy. If the devices operates under abnormal conditions this hardware/software solutions must limit the duration and number of activation cycles.

NCV8460A

ELECTRICAL CHARACTERISTICS ($8 \leq V_D \leq 36 \text{ V}$; $-40^\circ\text{C} < T_J < 150^\circ\text{C}$ unless otherwise specified)

Rating	Symbol	Conditions	Value			Unit
			Min	Typ	Max	
DIAGNOSTICS CHARACTERISTICS						
Openload On State Detection Threshold	I_{OL}	$V_{in} = 5 \text{ V}$	30		500	mA
Openload On State Detection Delay	$t_{d_OL_on}$	$I_{out} = 0 \text{ A}$			220	μs
Openload Off State Detection Threshold	V_{OL}	$V_{in} = 0 \text{ V}$	1.5	–	3.5	V
Openload Detection Delay at Turn Off	$t_{d_OL_off}$				1000	μs

3. Not subjected to production testing

4. To ensure long term reliability under heavy overload or short circuit conditions, protection and related diagnostic signals must be used together with a proper hardware/software strategy. If the device operates under abnormal conditions this hardware/software solutions must limit the duration and number of activation cycles.

Product parametric performance is indicated in the Electrical Characteristics for the listed test conditions, unless otherwise noted. Product performance may not be indicated by the Electrical Characteristics if operated under different conditions.

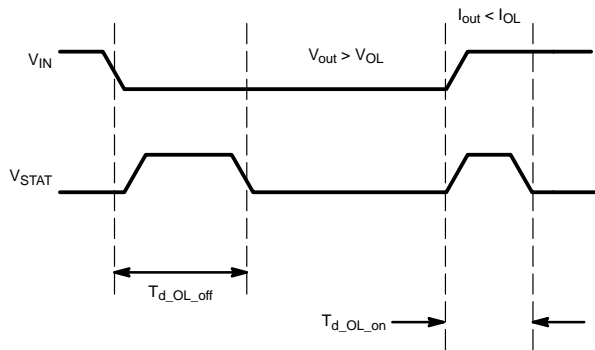

Figure 2. Open Load Status Timing (with external pull-up)

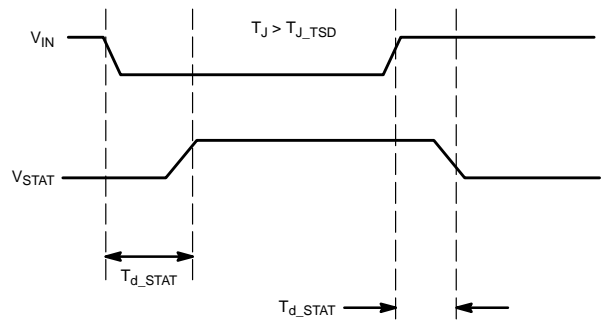

Figure 3. Overtemperature Status Timing

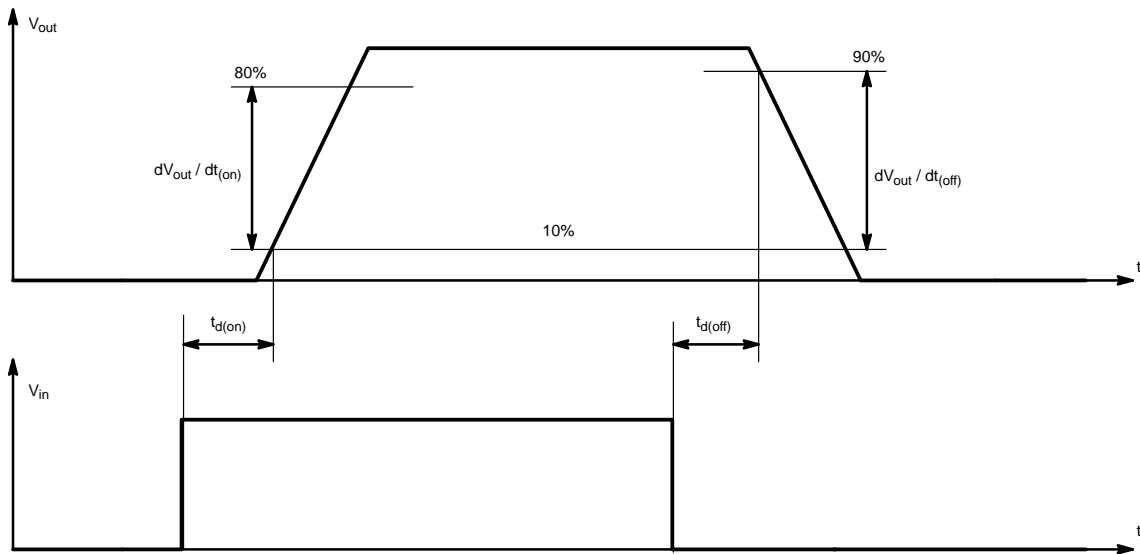

Figure 4. Switching Timing Diagram

NCV8460A

STATUS PIN TRUTH TABLE

Conditions	Input	Output	Status
Normal Operation	L	L	H
	H	H	H
Undervoltage	L	L	X
	H	L	X
Overvoltage	L	L	H
	H	L	H
Current Limitation	L	L	H
	H	X	($T_J < T_{SD}$) H
	H	X	($T_J > T_{SD}$) L
Overtemperature	L	L	H
	H	L	L
Output Voltage > V_{OL}	L	H	L
	H	H	H
Output Current < I_{OL}	L	L	H
	H	H	L

NCV8460A

TYPICAL CHARACTERISTICS CURVES

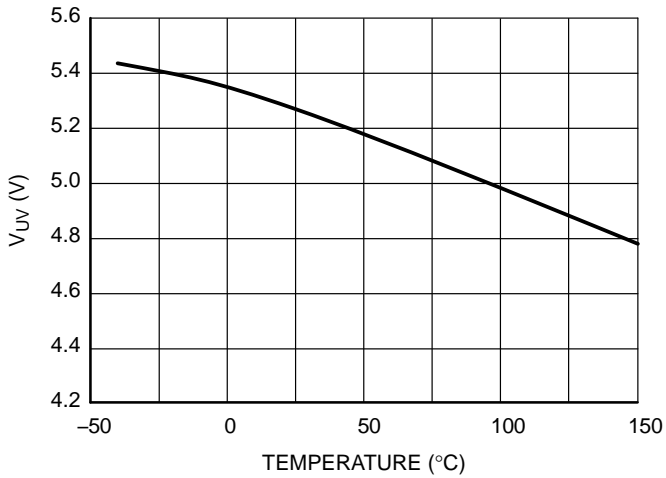

Figure 5. Undervoltage Shutdown vs. Temperature

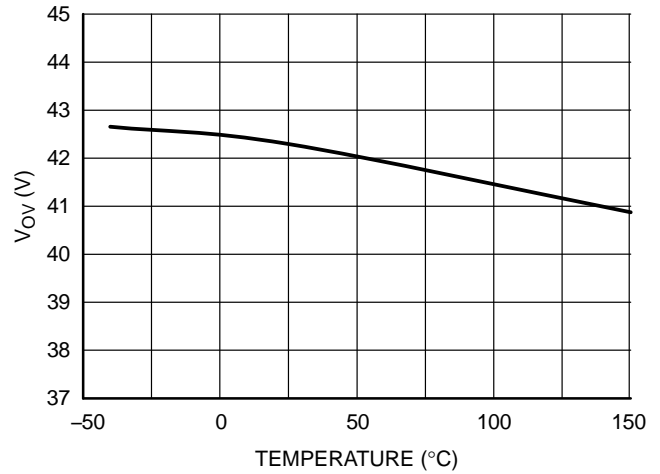

Figure 6. Overvoltage Shutdown vs. Temperature

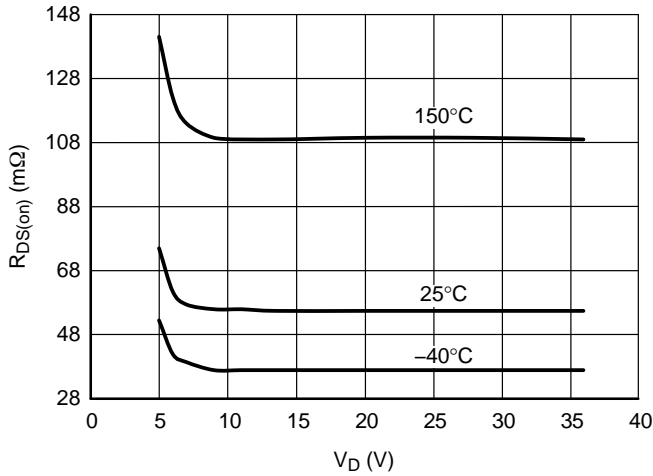

Figure 7. R_{DS(on)} vs. V_D

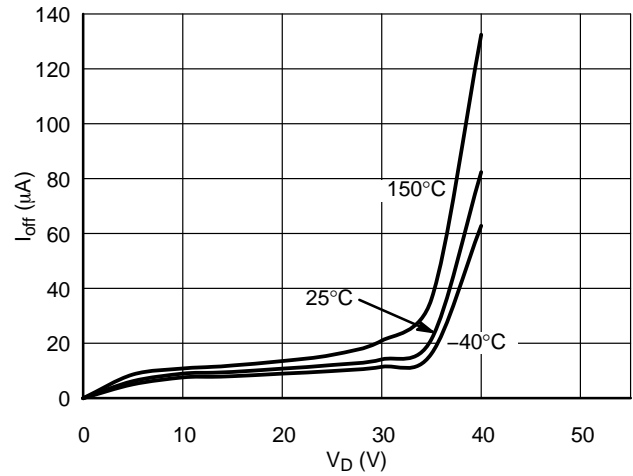
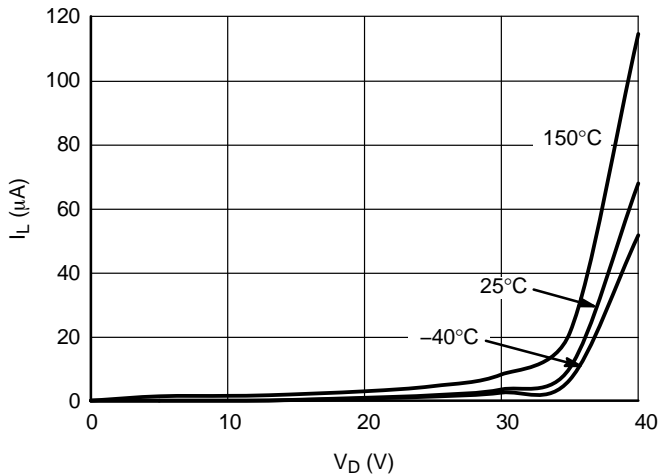

Figure 8. OFF State Standby Current vs. V_D



**Figure 9. Output Leakage vs. V_D
V_{out} = 0 V**

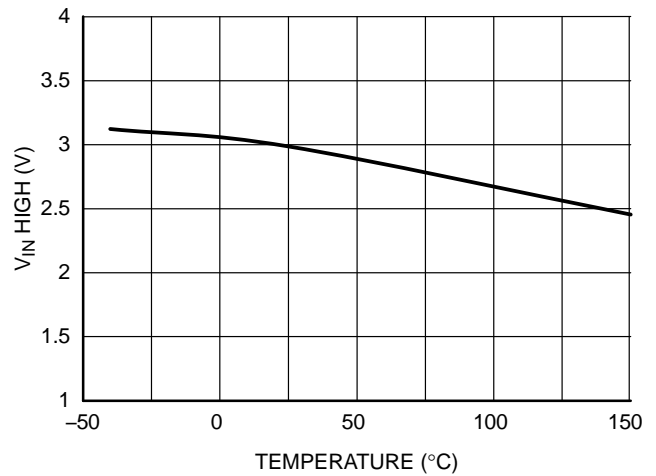

Figure 10. V_{in} Threshold High vs. Temperature

NCV8460A

TYPICAL CHARACTERISTICS CURVES

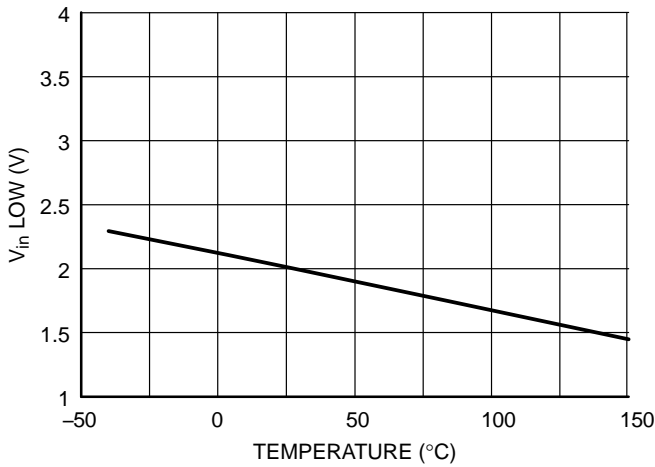

Figure 11. V_{in} Threshold Low vs. Temperature

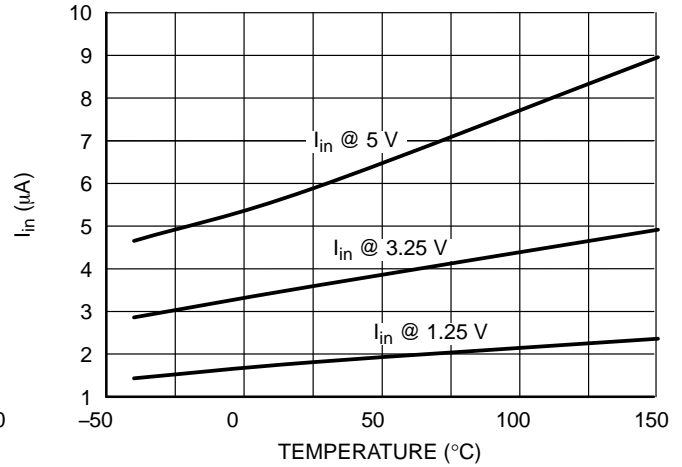

Figure 12. Input Current vs. Temperature

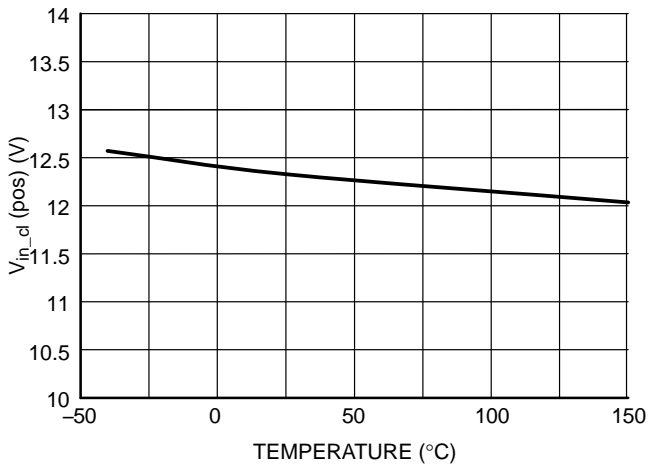

Figure 13. Input Clamp Voltage (Positive) vs. Temperature

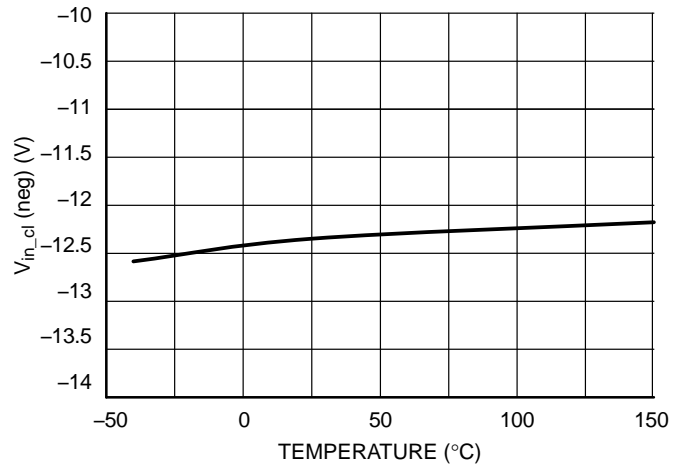

Figure 14. Input Clamp Voltage (Negative) vs. Temperature

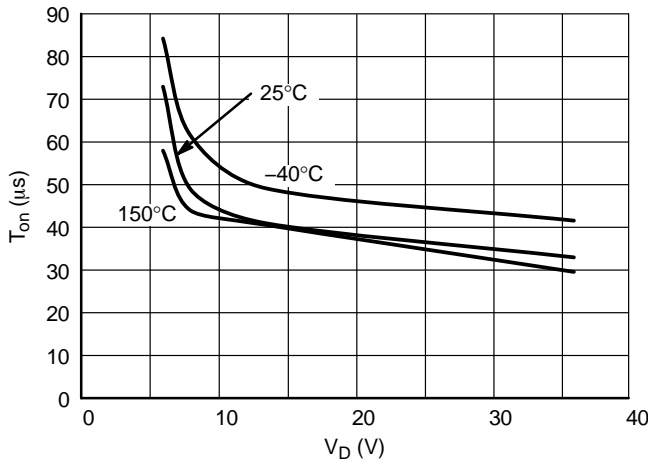

Figure 15. Turn On Time vs. V_D

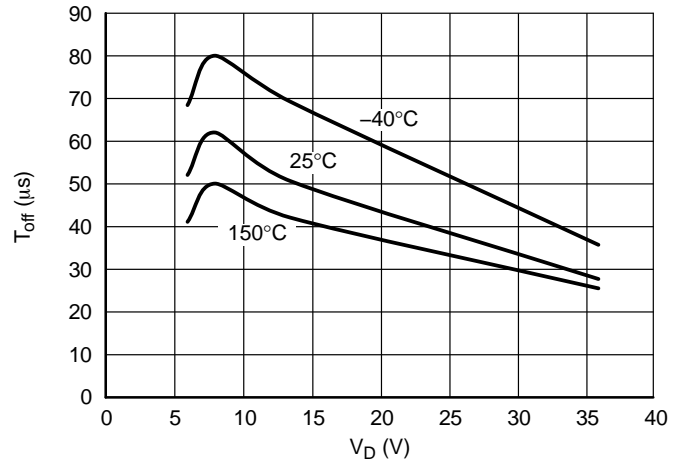

Figure 16. Turn Off Time vs. V_D

TYPICAL CHARACTERISTICS CURVES

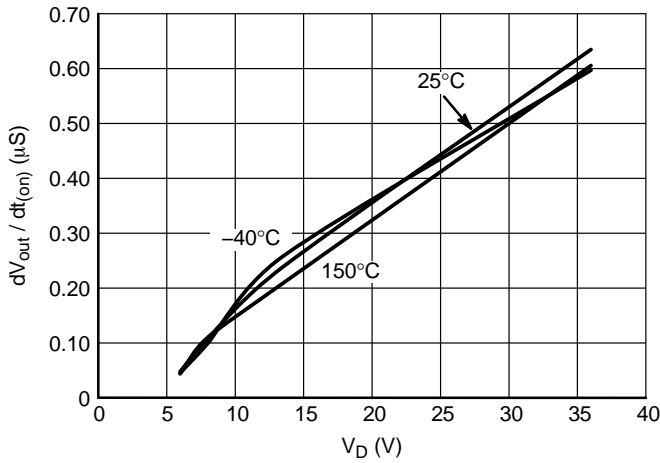

Figure 17. Slew Rate ON vs. V_D

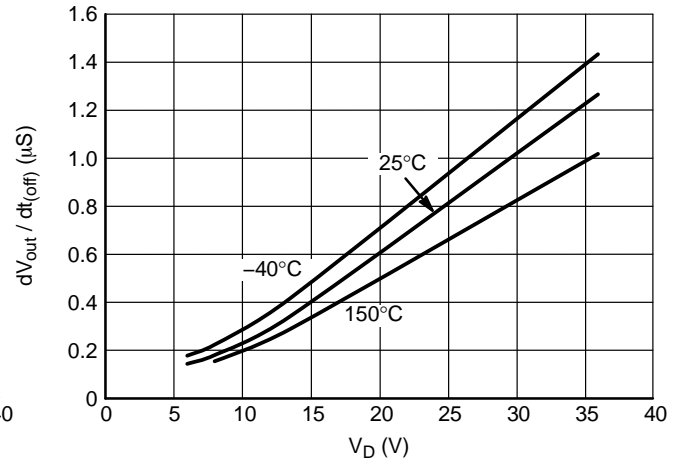

Figure 18. Slew Rate OFF vs. V_D

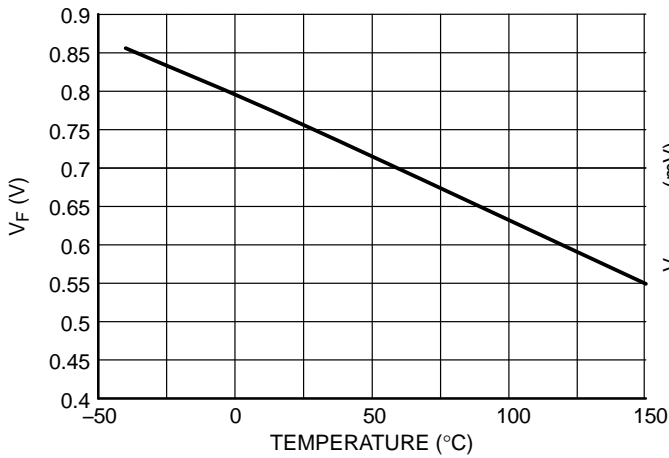

Figure 19. Forward Voltage (@ -1.3 A) vs. Temperature

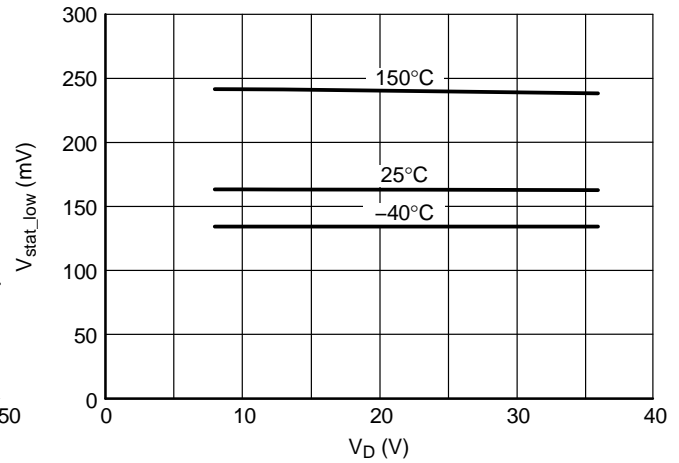

Figure 20. STAT Low Voltage vs. V_D

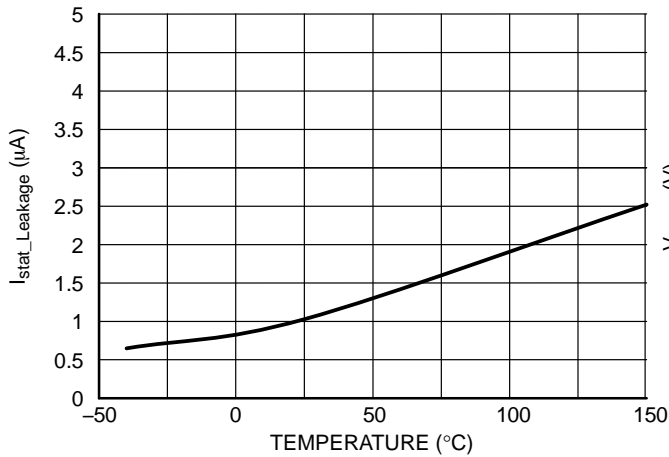

Figure 21. Status Leakage Current vs. Temperature

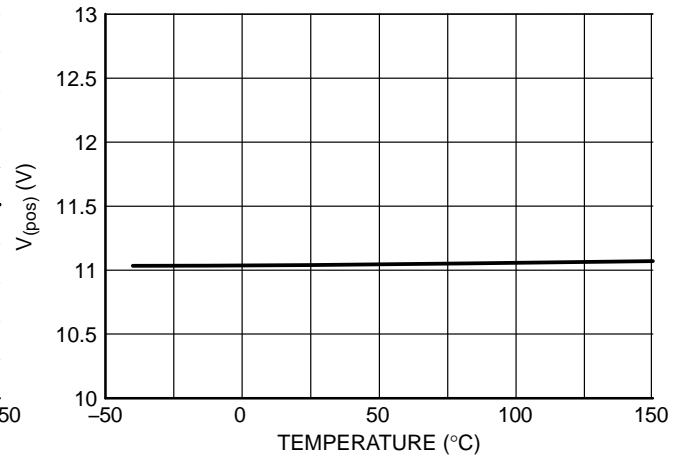

Figure 22. Status Clamp Voltage (Positive) vs. Temperature

TYPICAL CHARACTERISTICS CURVES

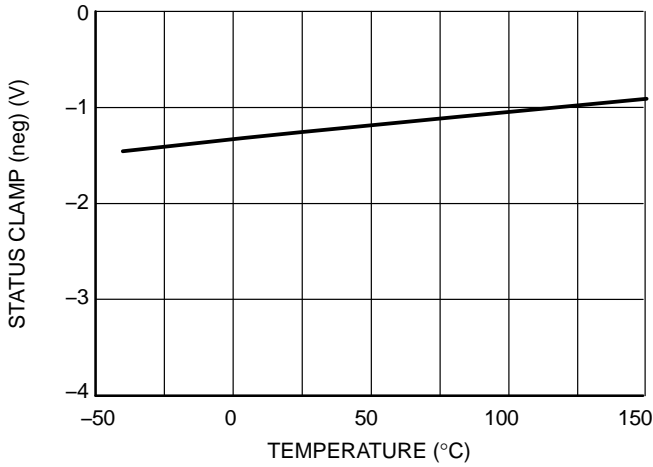

Figure 23. Status Clamp Voltage (Negative) vs. Temperature

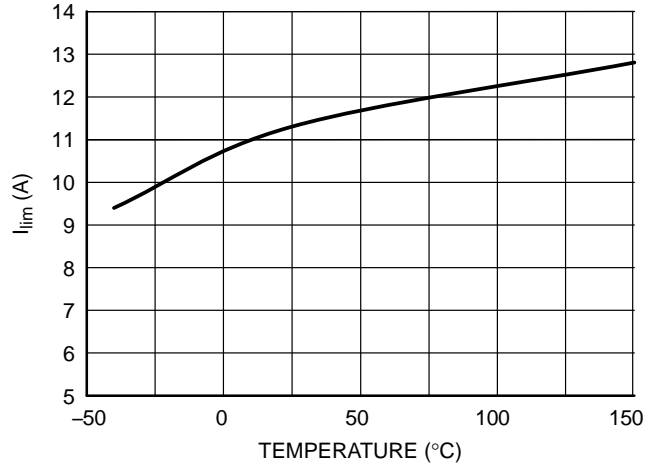

Figure 24. Current Limit vs. Temperature
 $V_D = 13.5$ V

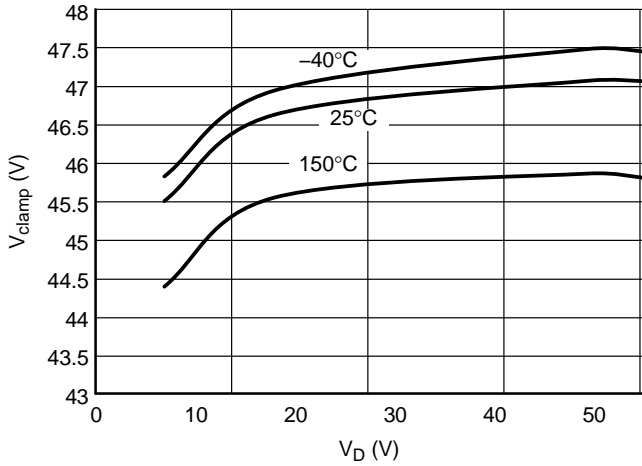

Figure 25. Turn Off Output Clamp Voltage vs. V_D and Temperature

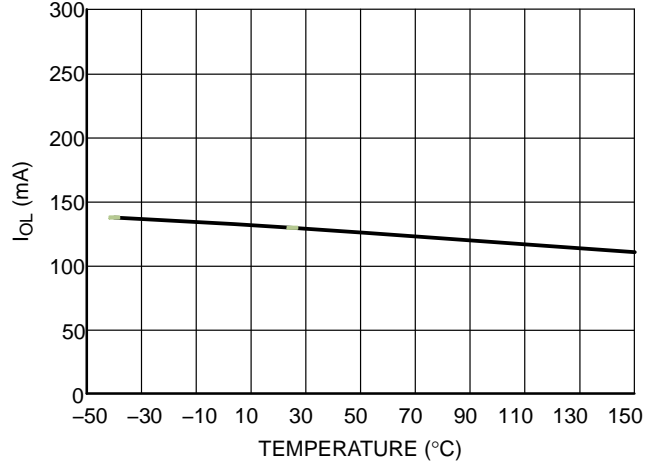

Figure 26. ON State Open Load Detection vs. Temperature
 $V_D = 13.5$ V

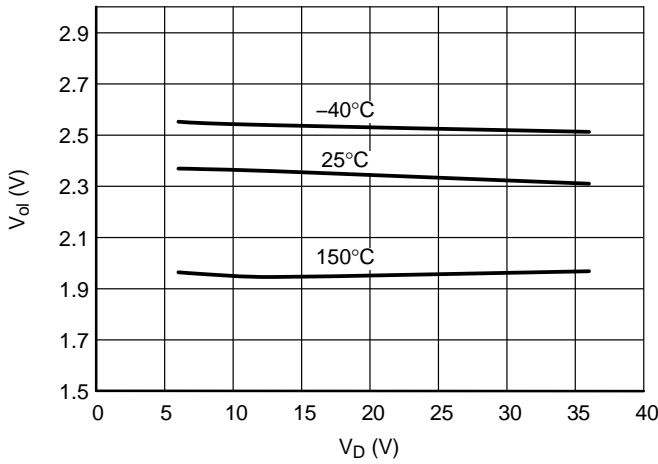

Figure 27. Off State OL Detection Threshold vs. V_D and Temperature

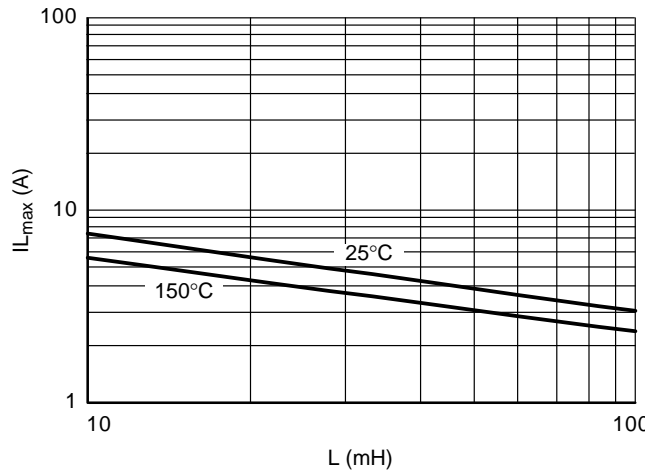

Figure 28. Single-Pulse Maximum Switch-off Current vs. Load Inductance

NCV8460A

TYPICAL CHARACTERISTICS CURVES

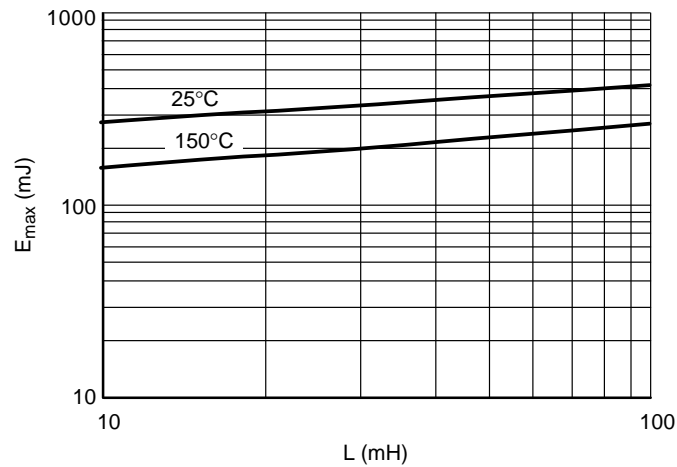

Figure 29. Single-Pulse Maximum Switch-off Current vs. Load Inductance

ISO 7637-2: 2004(E) PULSE TEST RESULTS

ISO 7637-2:2004(E)	Test Levels				Delays and Impedance
Test Pulse	I	II	III	IV	
1	-25 V	-50 V	-75 V	-100 V	2 ms, 10 Ω
2a	+25 V	+50 V	+37 V	+50 V	0.05 ms, 10 Ω
3a	-25 V	-50 V	-112 V	-150 V	0.1 μs, 50 Ω
3b	+25 V	+50 V	+75 V	+100 V	0.1 μs, 50 Ω
4	-4 V	-5 V	-6 V	-7 V	5 s, .01 Ω
5 (Load Dump)	+26.5 V	+46.5 V	+66.5 V	+86.5 V	400 ms, 2 Ω

ISO 7637-2:2004(E)	Test Results			
Test Pulse	I	II	III	IV
1	C	C	C	C
2a	C	C	C	C
3a	C	C	C	C
3b	C	C	C	C
4	C	C	C	C
5 (Load Dump)	C	E	E	E

Class	Functional Status
A	All functions of a device perform as designed during and after exposure to disturbance.
B	All functions of a device perform as designed during exposure. However, one or more of them can go beyond specified tolerance. All functions return automatically to within normal limits after exposure is removed. Memory functions shall remain class A.
C	One or more functions of a device do not perform as designed during exposure but return automatically to normal operation after exposure is removed.
D	One or more functions of a device do not perform as designed during exposure and do not return to normal operation until exposure is removed and the device is reset by simple
E	One or more functions of a device do not perform as designed during and after exposure and cannot be returned to proper operation without replacing the device.

NCV8460A

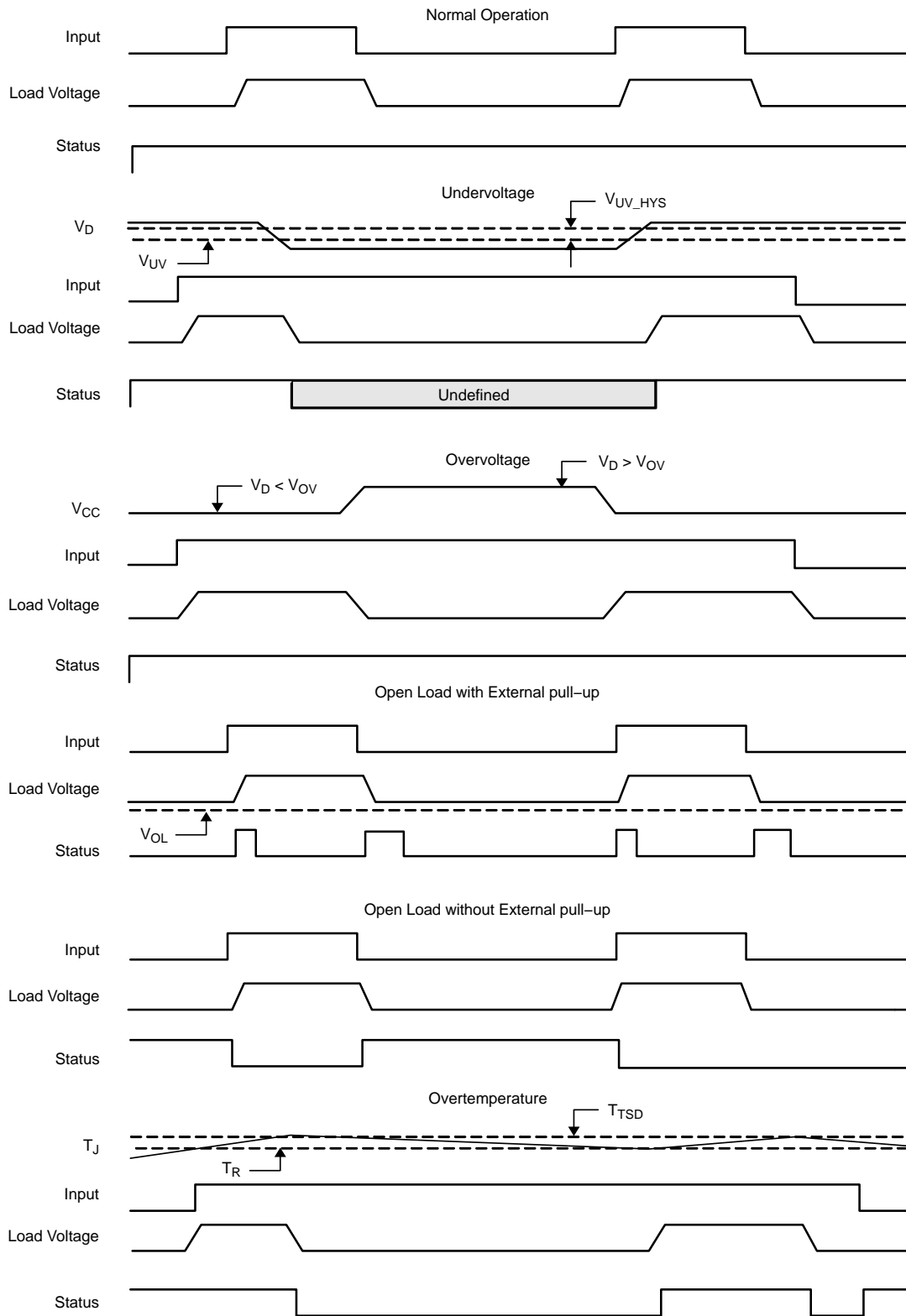

Figure 30. Waveforms

NCV8460A

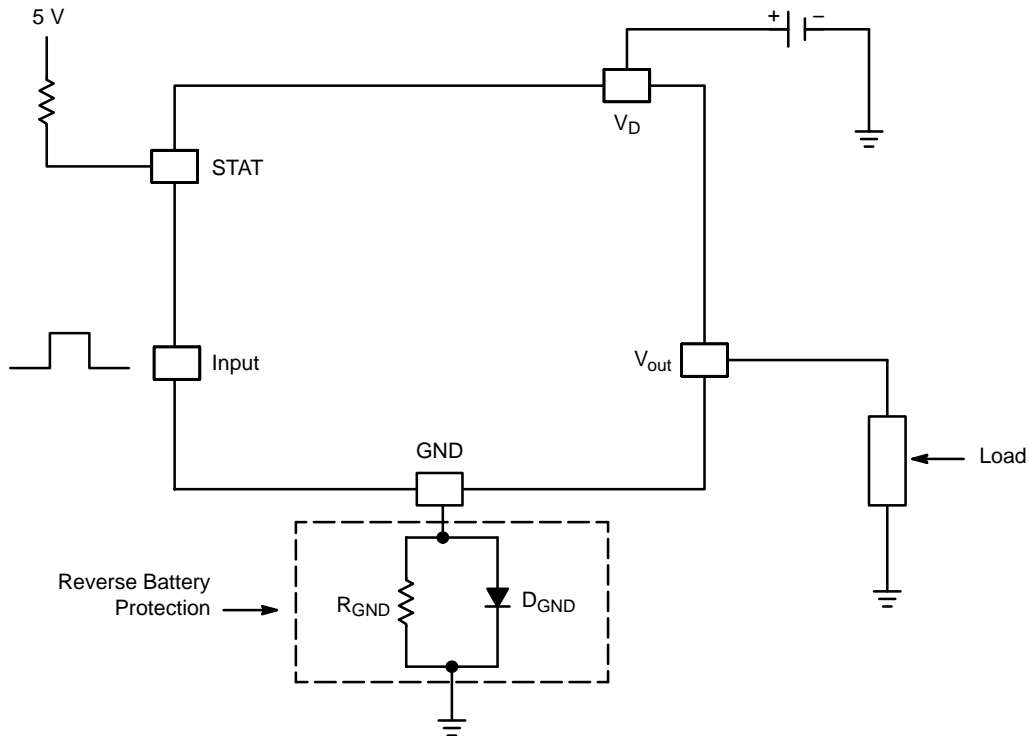

Figure 31. Application Diagram

Reverse Battery Protection

An external resistor R_{GND} is required to adequately protect the device from a Reverse Battery event. The resistor value can be calculated using the following two formulas.

1. $R_{GND} \leq 600 \text{ mV} / (I_d \text{ (on) max})$
2. $R_{GND} \geq (-V_D) / (-I_{gnd})$

Maximum $(-I_{gnd})$ current, which is the reverse GND pin current, can be found in the Maximum Ratings section. Several High Side Devices can share same the reverse battery protection resistor. Please note that the sum of $(I_d \text{ (on) max})$ of all devices should be used to calculate R_{GND} value. If the microprocessor ground is not common with the device ground, R_{GND} will produce a voltage offset $((I_d \text{ (on) max}) \times R_{GND})$ with respect to the IN and STAT pins.

This offset will be increased when more than one device shares the resistor.

Power Dissipation during a reverse battery event is equal to:

$$P_D = (-V_D)^2 / R_{GND}$$

In the case of high power dissipation due to several devices sharing R_{GND} , it is recommended to place a diode D_{GND} in the ground path as an alternate reverse battery protection method. When driving an inductive load, a 1 k Ω resistor should be placed in parallel with the D_{GND} diode. This method will also produce a voltage offset of ~600 mV with respect to the IN and STAT pins. This diode can also be shared amongst several High Side Devices. This voltage offset will vary if D_{GND} is shared by multiple devices.

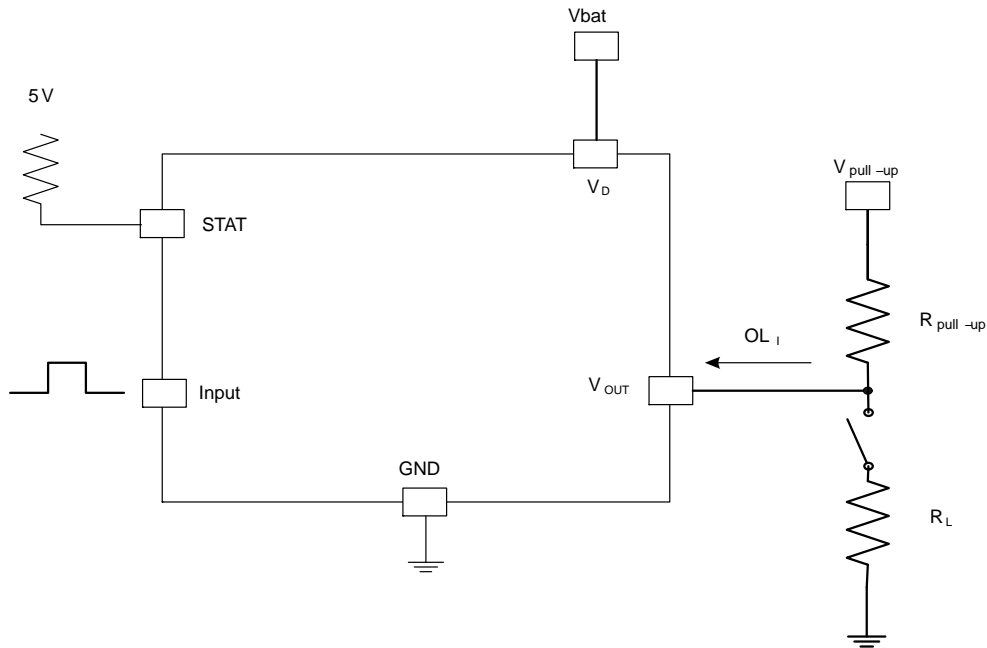

Figure 32. Open Load Detection In Off State

OFF State Open Load Detection

Off State Open Load Detection requires an external pull-up resistor ($R_{pull-up}$) connected between V_{OUT} pin and a positive supply voltage ($V_{pull-up}$).

The external $R_{pull-up}$ resistor value should be selected to ensure that a false OFF State OL condition is not detected when the load (R_L) is connected. A V_{OUT} voltage above the V_{OL_min} (Openload Off State Detection Threshold) minimum value with the load (R_L) connected needs to be avoided. The following formula shows this relationship:

$$V_{OUT} = \left(V_{pull-up} / (R_L + R_{pull-up}) \right) R_L < V_{OL_min}$$

In addition to ensuring the selected $R_{pull-up}$ resistor value does not cause a false OFF State OL detection condition

when the load is connected, the $R_{pull-up}$ must also not cause the OFF State OL to miss detecting an OL condition when the load is disconnected. A V_{OUT} voltage below the V_{OL_max} (Openload Off State Detection Threshold) maximum value with the load (R_L) disconnected needs to be avoided. The following formula shows this relationship:

$$R_{pull-up} < (V_{pull-up} - V_{OL_max}) / OL_1$$

$$OL_1 = I_L (\text{Output Leakage with } V_{OUT} = 3.5 \text{ V})$$

Because I_d (OFF) may significantly increase if V_{OUT} is pulled high (up to several mA), $R_{pull-up}$ resistor should be connected to a supply that is switched OFF when the module is in standby.

NCV8460A

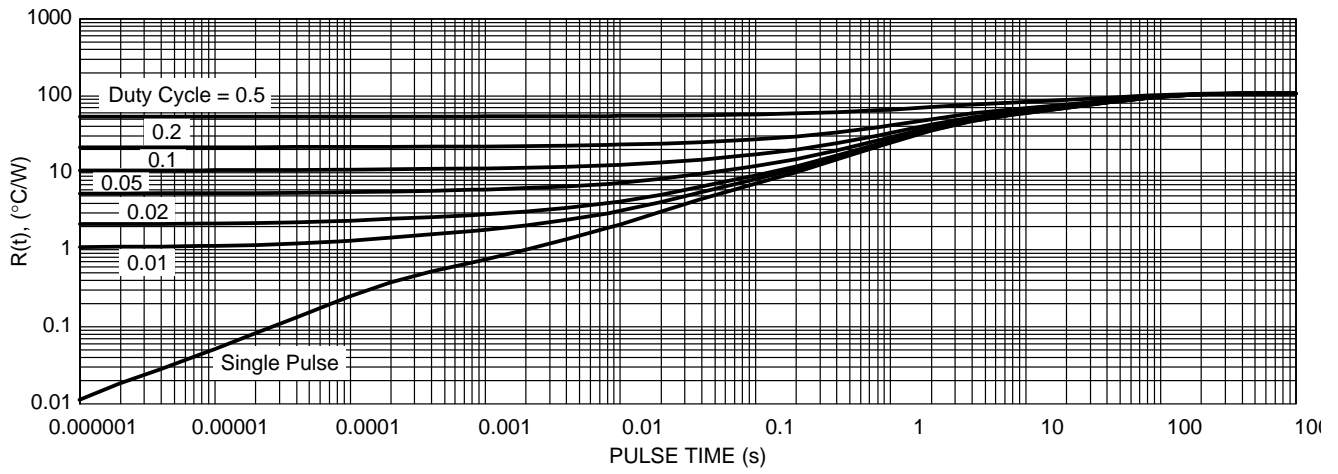

Figure 33. Transient Thermal Impedance

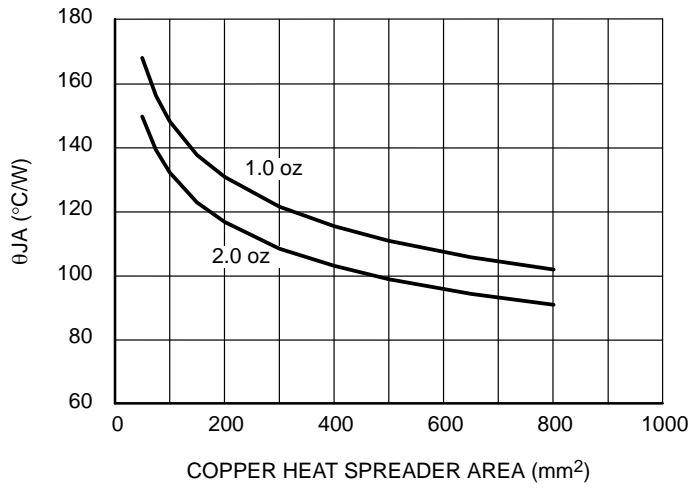

Figure 34. $R_{\theta JA}$ vs Copper Area

MECHANICAL CASE OUTLINE PACKAGE DIMENSIONS



SCALE 1:1

SOIC-8 NB
CASE 751-07
ISSUE AK

DATE 16 FEB 2011



- NOTES:
1. DIMENSIONING AND TOLERANCING PER ANSI Y14.5M, 1982.
 2. CONTROLLING DIMENSION: MILLIMETER.
 3. DIMENSION A AND B DO NOT INCLUDE MOLD PROTRUSION.
 4. MAXIMUM MOLD PROTRUSION 0.15 (0.006) PER SIDE.
 5. DIMENSION D DOES NOT INCLUDE DAMBAR PROTRUSION. ALLOWABLE DAMBAR PROTRUSION SHALL BE 0.127 (0.005) TOTAL IN EXCESS OF THE D DIMENSION AT MAXIMUM MATERIAL CONDITION.
 6. 751-01 THRU 751-06 ARE OBSOLETE. NEW STANDARD IS 751-07.

DIM	MILLIMETERS		INCHES	
	MIN	MAX	MIN	MAX
A	4.80	5.00	0.189	0.197
B	3.80	4.00	0.150	0.157
C	1.35	1.75	0.053	0.069
D	0.33	0.51	0.013	0.020
G	1.27 BSC		0.050 BSC	
H	0.10	0.25	0.004	0.010
J	0.19	0.25	0.007	0.010
K	0.40	1.27	0.016	0.050
M	0°	8°	0°	8°
N	0.25	0.50	0.010	0.020
S	5.80	6.20	0.228	0.244

GENERIC MARKING DIAGRAM*

SOLDERING FOOTPRINT*

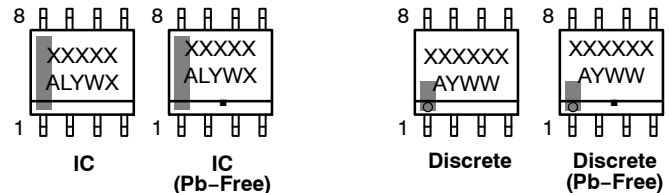
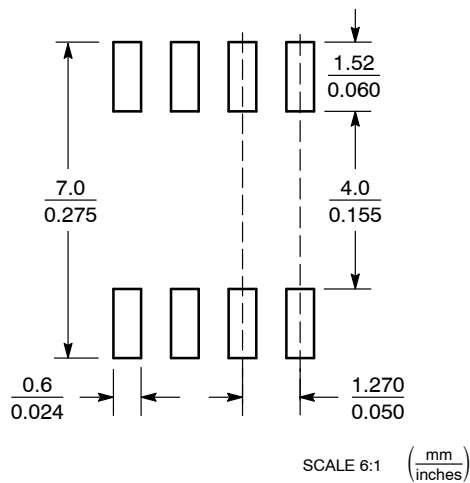

XXXXXX = Specific Device Code
 A = Assembly Location
 L = Wafer Lot
 Y = Year
 W = Work Week
 ■ = Pb-Free Package

XXXXXX = Specific Device Code
 A = Assembly Location
 Y = Year
 WW = Work Week
 ■ = Pb-Free Package

*This information is generic. Please refer to device data sheet for actual part marking. Pb-Free indicator, "G" or microdot "•", may or may not be present. Some products may not follow the Generic Marking.

*For additional information on our Pb-Free strategy and soldering details, please download the ON Semiconductor Soldering and Mounting Techniques Reference Manual, SOLDERRM/D.

STYLES ON PAGE 2

DOCUMENT NUMBER:	98ASB42564B	Electronic versions are uncontrolled except when accessed directly from the Document Repository. Printed versions are uncontrolled except when stamped "CONTROLLED COPY" in red.
DESCRIPTION:	SOIC-8 NB	PAGE 1 OF 2

onsemi and ONsemi are trademarks of Semiconductor Components Industries, LLC dba onsemi or its subsidiaries in the United States and/or other countries. onsemi reserves the right to make changes without further notice to any products herein. onsemi makes no warranty, representation or guarantee regarding the suitability of its products for any particular purpose, nor does onsemi assume any liability arising out of the application or use of any product or circuit, and specifically disclaims any and all liability, including without limitation special, consequential or incidental damages. onsemi does not convey any license under its patent rights nor the rights of others.

SOIC-8 NB
CASE 751-07
ISSUE AK

DATE 16 FEB 2011

- | | | | |
|---|--|--|--|
| <p>STYLE 1:
 PIN 1. EMITTER
 2. COLLECTOR
 3. COLLECTOR
 4. EMITTER
 5. EMITTER
 6. BASE
 7. BASE
 8. EMITTER</p> | <p>STYLE 2:
 PIN 1. COLLECTOR, DIE, #1
 2. COLLECTOR, #1
 3. COLLECTOR, #2
 4. COLLECTOR, #2
 5. BASE, #2
 6. EMITTER, #2
 7. BASE, #1
 8. EMITTER, #1</p> | <p>STYLE 3:
 PIN 1. DRAIN, DIE #1
 2. DRAIN, #1
 3. DRAIN, #2
 4. DRAIN, #2
 5. GATE, #2
 6. SOURCE, #2
 7. GATE, #1
 8. SOURCE, #1</p> | <p>STYLE 4:
 PIN 1. ANODE
 2. ANODE
 3. ANODE
 4. ANODE
 5. ANODE
 6. ANODE
 7. ANODE
 8. COMMON CATHODE</p> |
| <p>STYLE 5:
 PIN 1. DRAIN
 2. DRAIN
 3. DRAIN
 4. DRAIN
 5. GATE
 6. GATE
 7. SOURCE
 8. SOURCE</p> | <p>STYLE 6:
 PIN 1. SOURCE
 2. DRAIN
 3. DRAIN
 4. SOURCE
 5. SOURCE
 6. GATE
 7. GATE
 8. SOURCE</p> | <p>STYLE 7:
 PIN 1. INPUT
 2. EXTERNAL BYPASS
 3. THIRD STAGE SOURCE
 4. GROUND
 5. DRAIN
 6. GATE 3
 7. SECOND STAGE Vd
 8. FIRST STAGE Vd</p> | <p>STYLE 8:
 PIN 1. COLLECTOR, DIE #1
 2. BASE, #1
 3. BASE, #2
 4. COLLECTOR, #2
 5. COLLECTOR, #2
 6. EMITTER, #2
 7. EMITTER, #1
 8. COLLECTOR, #1</p> |
| <p>STYLE 9:
 PIN 1. EMITTER, COMMON
 2. COLLECTOR, DIE #1
 3. COLLECTOR, DIE #2
 4. EMITTER, COMMON
 5. EMITTER, COMMON
 6. BASE, DIE #2
 7. BASE, DIE #1
 8. EMITTER, COMMON</p> | <p>STYLE 10:
 PIN 1. GROUND
 2. BIAS 1
 3. OUTPUT
 4. GROUND
 5. GROUND
 6. BIAS 2
 7. INPUT
 8. GROUND</p> | <p>STYLE 11:
 PIN 1. SOURCE 1
 2. GATE 1
 3. SOURCE 2
 4. GATE 2
 5. DRAIN 2
 6. DRAIN 2
 7. DRAIN 1
 8. DRAIN 1</p> | <p>STYLE 12:
 PIN 1. SOURCE
 2. SOURCE
 3. SOURCE
 4. GATE
 5. DRAIN
 6. DRAIN
 7. DRAIN
 8. DRAIN</p> |
| <p>STYLE 13:
 PIN 1. N.C.
 2. SOURCE
 3. SOURCE
 4. GATE
 5. DRAIN
 6. DRAIN
 7. DRAIN
 8. DRAIN</p> | <p>STYLE 14:
 PIN 1. N-SOURCE
 2. N-GATE
 3. P-SOURCE
 4. P-GATE
 5. P-DRAIN
 6. P-DRAIN
 7. N-DRAIN
 8. N-DRAIN</p> | <p>STYLE 15:
 PIN 1. ANODE 1
 2. ANODE 1
 3. ANODE 1
 4. ANODE 1
 5. CATHODE, COMMON
 6. CATHODE, COMMON
 7. CATHODE, COMMON
 8. CATHODE, COMMON</p> | <p>STYLE 16:
 PIN 1. EMITTER, DIE #1
 2. BASE, DIE #1
 3. EMITTER, DIE #2
 4. BASE, DIE #2
 5. COLLECTOR, DIE #2
 6. COLLECTOR, DIE #2
 7. COLLECTOR, DIE #1
 8. COLLECTOR, DIE #1</p> |
| <p>STYLE 17:
 PIN 1. VCC
 2. V2OUT
 3. V1OUT
 4. TXE
 5. RXE
 6. VEE
 7. GND
 8. ACC</p> | <p>STYLE 18:
 PIN 1. ANODE
 2. ANODE
 3. SOURCE
 4. GATE
 5. DRAIN
 6. DRAIN
 7. CATHODE
 8. CATHODE</p> | <p>STYLE 19:
 PIN 1. SOURCE 1
 2. GATE 1
 3. SOURCE 2
 4. GATE 2
 5. DRAIN 2
 6. MIRROR 2
 7. DRAIN 1
 8. MIRROR 1</p> | <p>STYLE 20:
 PIN 1. SOURCE (N)
 2. GATE (N)
 3. SOURCE (P)
 4. GATE (P)
 5. DRAIN
 6. DRAIN
 7. DRAIN
 8. DRAIN</p> |
| <p>STYLE 21:
 PIN 1. CATHODE 1
 2. CATHODE 2
 3. CATHODE 3
 4. CATHODE 4
 5. CATHODE 5
 6. COMMON ANODE
 7. COMMON ANODE
 8. CATHODE 6</p> | <p>STYLE 22:
 PIN 1. I/O LINE 1
 2. COMMON CATHODE/VCC
 3. COMMON CATHODE/VCC
 4. I/O LINE 3
 5. COMMON ANODE/GND
 6. I/O LINE 4
 7. I/O LINE 5
 8. COMMON ANODE/GND</p> | <p>STYLE 23:
 PIN 1. LINE 1 IN
 2. COMMON ANODE/GND
 3. COMMON ANODE/GND
 4. LINE 2 IN
 5. LINE 2 OUT
 6. COMMON ANODE/GND
 7. COMMON ANODE/GND
 8. LINE 1 OUT</p> | <p>STYLE 24:
 PIN 1. BASE
 2. EMITTER
 3. COLLECTOR/ANODE
 4. COLLECTOR/ANODE
 5. CATHODE
 6. CATHODE
 7. COLLECTOR/ANODE
 8. COLLECTOR/ANODE</p> |
| <p>STYLE 25:
 PIN 1. VIN
 2. N/C
 3. REXT
 4. GND
 5. IOUT
 6. IOUT
 7. IOUT
 8. IOUT</p> | <p>STYLE 26:
 PIN 1. GND
 2. dv/dt
 3. ENABLE
 4. ILIMIT
 5. SOURCE
 6. SOURCE
 7. SOURCE
 8. VCC</p> | <p>STYLE 27:
 PIN 1. ILIMIT
 2. OVLO
 3. UVLO
 4. INPUT+
 5. SOURCE
 6. SOURCE
 7. SOURCE
 8. DRAIN</p> | <p>STYLE 28:
 PIN 1. SW_TO_GND
 2. DASIC_OFF
 3. DASIC_SW_DET
 4. GND
 5. V_MON
 6. VBULK
 7. VBULK
 8. VIN</p> |
| <p>STYLE 29:
 PIN 1. BASE, DIE #1
 2. EMITTER, #1
 3. BASE, #2
 4. EMITTER, #2
 5. COLLECTOR, #2
 6. COLLECTOR, #2
 7. COLLECTOR, #1
 8. COLLECTOR, #1</p> | <p>STYLE 30:
 PIN 1. DRAIN 1
 2. DRAIN 1
 3. GATE 2
 4. SOURCE 2
 5. SOURCE 1/DRAIN 2
 6. SOURCE 1/DRAIN 2
 7. SOURCE 1/DRAIN 2
 8. GATE 1</p> | | |

DOCUMENT NUMBER:	98ASB42564B	Electronic versions are uncontrolled except when accessed directly from the Document Repository. Printed versions are uncontrolled except when stamped "CONTROLLED COPY" in red.
DESCRIPTION:	SOIC-8 NB	PAGE 2 OF 2

onsemi and **ONSEMI** are trademarks of Semiconductor Components Industries, LLC dba **onsemi** or its subsidiaries in the United States and/or other countries. **onsemi** reserves the right to make changes without further notice to any products herein. **onsemi** makes no warranty, representation or guarantee regarding the suitability of its products for any particular purpose, nor does **onsemi** assume any liability arising out of the application or use of any product or circuit, and specifically disclaims any and all liability, including without limitation special, consequential or incidental damages. **onsemi** does not convey any license under its patent rights nor the rights of others.

onsemi, **Onsemi**, and other names, marks, and brands are registered and/or common law trademarks of Semiconductor Components Industries, LLC dba "**onsemi**" or its affiliates and/or subsidiaries in the United States and/or other countries. **onsemi** owns the rights to a number of patents, trademarks, copyrights, trade secrets, and other intellectual property. A listing of **onsemi**'s product/patent coverage may be accessed at www.onsemi.com/site/pdf/Patent-Marking.pdf. **onsemi** reserves the right to make changes at any time to any products or information herein, without notice. The information herein is provided "as-is" and **onsemi** makes no warranty, representation or guarantee regarding the accuracy of the information, product features, availability, functionality, or suitability of its products for any particular purpose, nor does **onsemi** assume any liability arising out of the application or use of any product or circuit, and specifically disclaims any and all liability, including without limitation special, consequential or incidental damages. Buyer is responsible for its products and applications using **onsemi** products, including compliance with all laws, regulations and safety requirements or standards, regardless of any support or applications information provided by **onsemi**. "Typical" parameters which may be provided in **onsemi** data sheets and/or specifications can and do vary in different applications and actual performance may vary over time. All operating parameters, including "Typicals" must be validated for each customer application by customer's technical experts. **onsemi** does not convey any license under any of its intellectual property rights nor the rights of others. **onsemi** products are not designed, intended, or authorized for use as a critical component in life support systems or any FDA Class 3 medical devices or medical devices with a same or similar classification in a foreign jurisdiction or any devices intended for implantation in the human body. Should Buyer purchase or use **onsemi** products for any such unintended or unauthorized application, Buyer shall indemnify and hold **onsemi** and its officers, employees, subsidiaries, affiliates, and distributors harmless against all claims, costs, damages, and expenses, and reasonable attorney fees arising out of, directly or indirectly, any claim of personal injury or death associated with such unintended or unauthorized use, even if such claim alleges that **onsemi** was negligent regarding the design or manufacture of the part. **onsemi** is an Equal Opportunity/Affirmative Action Employer. This literature is subject to all applicable copyright laws and is not for resale in any manner.

PUBLICATION ORDERING INFORMATION

LITERATURE FULFILLMENT:

Email Requests to: orderlit@onsemi.com

onsemi Website: www.onsemi.com

TECHNICAL SUPPORT

North American Technical Support:

Voice Mail: 1 800-282-9855 Toll Free USA/Canada

Phone: 011 421 33 790 2910

Europe, Middle East and Africa Technical Support:

Phone: 00421 33 790 2910

For additional information, please contact your local Sales Representative