



NOTE

All numerical values are in metric units [with U.S. customary units in brackets]. Dimensions are in millimeters. Unless otherwise specified, dimensions have a tolerance of ± 0.13 and angles have a tolerance of $\pm 2^\circ$. Figures are not drawn to scale.

1. INTRODUCTION

This specification covers the requirements for application of 40-position right-angle SFP-DD pc board connector. The connector consists of a housing and surface-mount contacts having spacing on 0.8 centerlines. The connector features a card entry slot that accepts 1.0 ± 0.1 thick integrated circuit card housed in the transceiver, alignment posts for stability of placement on the pc board, and standoffs.

The connector is supplied in tape-mounted form for manual or robotic machine placement (typically vacuum pick and place).

Basic terms and features of this product are provided in Figure 1.

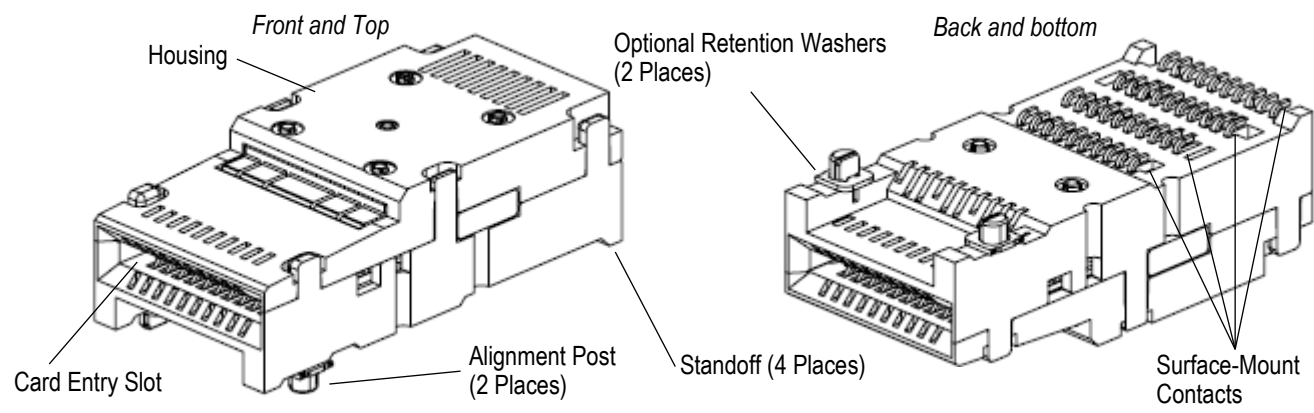

Figure 1

2. REFERENCE MATERIAL

2.1. Revision Summary

Initial release of application specification

2.2. Customer Assistance

Reference Product Base Part Number 2325864 and Product Code L996 are representative of 40-position right-angle SFP-DD pc board connector. Use of these numbers will identify the product line and help you to obtain product and tooling information when visiting www.te.com or calling the number at the bottom of this page.

2.3. Customer Drawings

Customer drawings for product part numbers are available from www.te.com. Information contained in the customer drawing takes priority.

2.4. Manual

Manual 402-40 can be used as a guide to soldering. This manual provides information on various flux types and characteristics with the commercial designation and flux removal procedures. A checklist is included in the manual as a guide for information on soldering problems.

2.5. Specifications

Product Specification [108-130026](#) provides expected product performance and test results.

2.6. Instructional Material

Instruction sheets (408-series) provide product assembly instructions or tooling setup and operation procedures. Instructional material that pertains to this product is:

[408-9816](#) Handling Reeled Product

2.7. Standards

The standard that pertains to this product is:

EIA-364-52, "Solderability of Contact Terminations Test Procedure for Electrical Connectors and Sockets"

3. REQUIREMENTS

3.1. Safety

Do not stack product shipping containers so high that the containers buckle or deform.

3.2. Operating Temperature

The connector is designed to operate in a temperature range of -55° to 85°C [-67° to 185°F].

3.3. Material

The housing is made of liquid crystal polymer (LCP) thermoplastic, UL 94-V-0. The contacts are made of copper alloy under plated with nickel, plated with tin on the solder tails, and plated with gold or gold equivalent at the interface area.

3.4. Storage

A. Ultraviolet Light

Prolonged exposure to ultraviolet light may deteriorate the chemical composition used in the product material.

B. Shelf Life

The product should remain in the shipping containers until ready for use to prevent deformation to components. The product should be used on a first in, first out basis to avoid storage contamination that could adversely affect performance.

C. Chemical Exposure

Do not store product near any chemical listed below as they may cause stress corrosion cracking in the material.

Alkalies	Ammonia	Citrates	Phosphates	Citrates	Sulfur Compounds
Amines	Carbonates	Nitrites	Sulfur Nitrites		Tartrates

3.5. PC Board

A. Material and Thickness

The pc board material shall be glass epoxy (FR-4 or G-10). The pc board thickness shall be a minimum of 1.57 for single sided applications and 2.2 for belly to belly applications.



NOTE

Contact product information at the number listed at the bottom of page 1 for suitability of other pc board materials.

B. Tolerance

Maximum allowable bow of the board shall be 0.08 over the length of the connector. The coplanarity of the pc board circuit pads must be 0.03.

C. Circuit Pads

The circuit pads must be solderable in accordance with EIA-364-52.

D. Layout

All holes and circuit pads must be precisely located on the pc board. The pc board layout must be designed using the dimensions provided on the customer drawing for the specific connector. A reference sample of the recommended pc board layout is given in Figure 2.

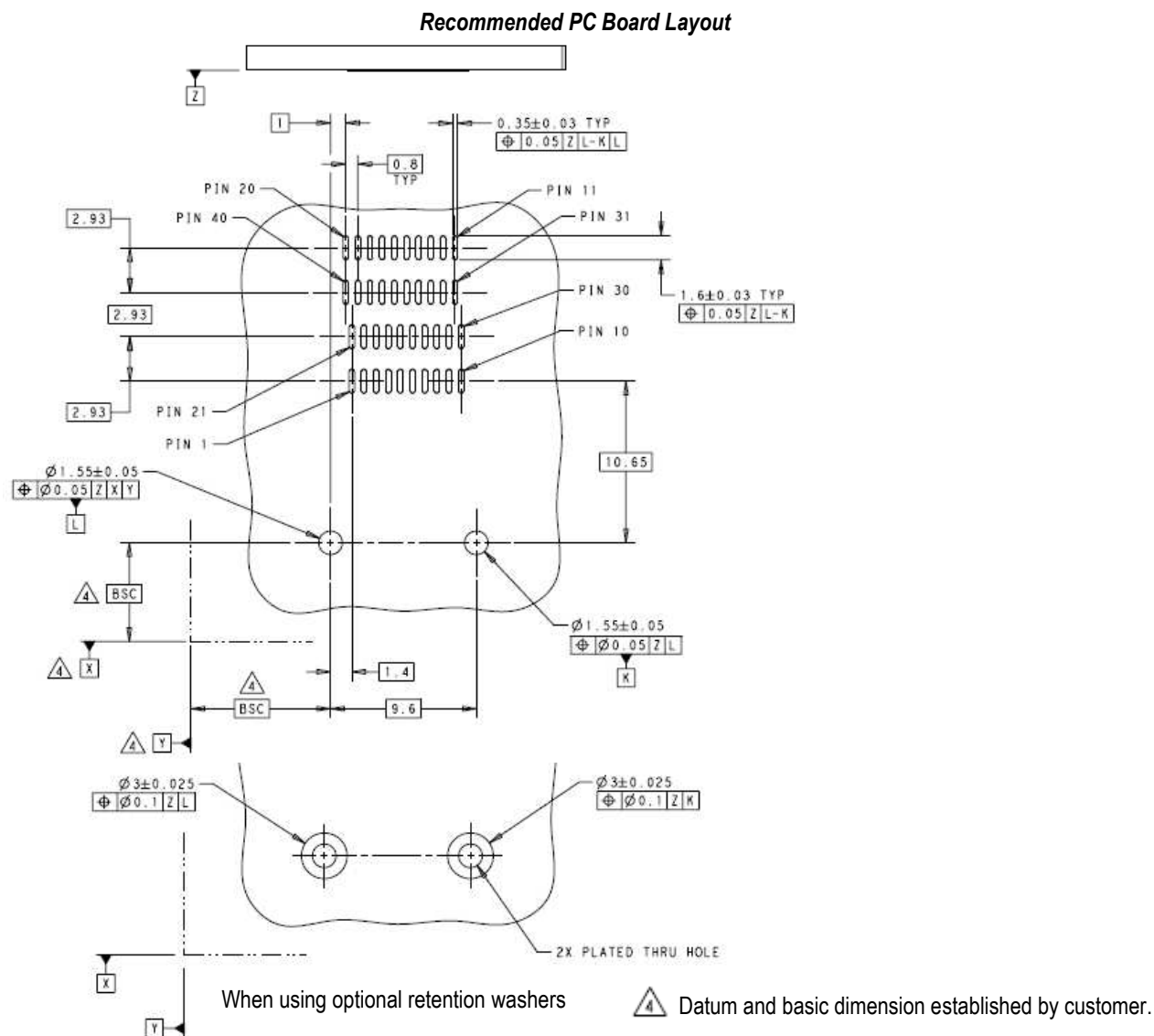

Figure 2

3.6. Soldering

A. Process

The connector must be soldered using non-focused infrared (IR) reflow or equivalent soldering technique. Reflow temperature and time may vary depending on the size of the pc board and placement of other components. This connector can be subjected to the reflow temperature and approximate time specified in Figure 3.

B. Solder Paste Characteristics

1. Alloy type for tin-lead solder shall be 63 Sn/37 Pb, 60 Sn/40 Pb, or 62 Sn/36 Pb/2 Ag.
2. Alloy type for lead-free solder shall be compatible with pure tin or gold, for example, SAC305 (96.6 Sn/3 Ag/0.5 Cu) or SAC405 (95.5 Sn/4 Ag/0.5 Cu)
3. Flux incorporated in the paste shall be rosin, mildly active (RMA) type.
4. Paste will be at least 80% solids by volume.
5. Mesh designation shall be -200 to +325 (74 to 44 square micron openings, respectively).
6. Minimum viscosity of screen print shall be 5×10% cp (centipoise).
7. Minimum viscosity of stencil print shall be 7.5×10% cp (centipoise).

Reflow Soldering Process Cycle

Tin-Lead Solder
 (Maximum 230°C [446°F] for 20 Seconds)

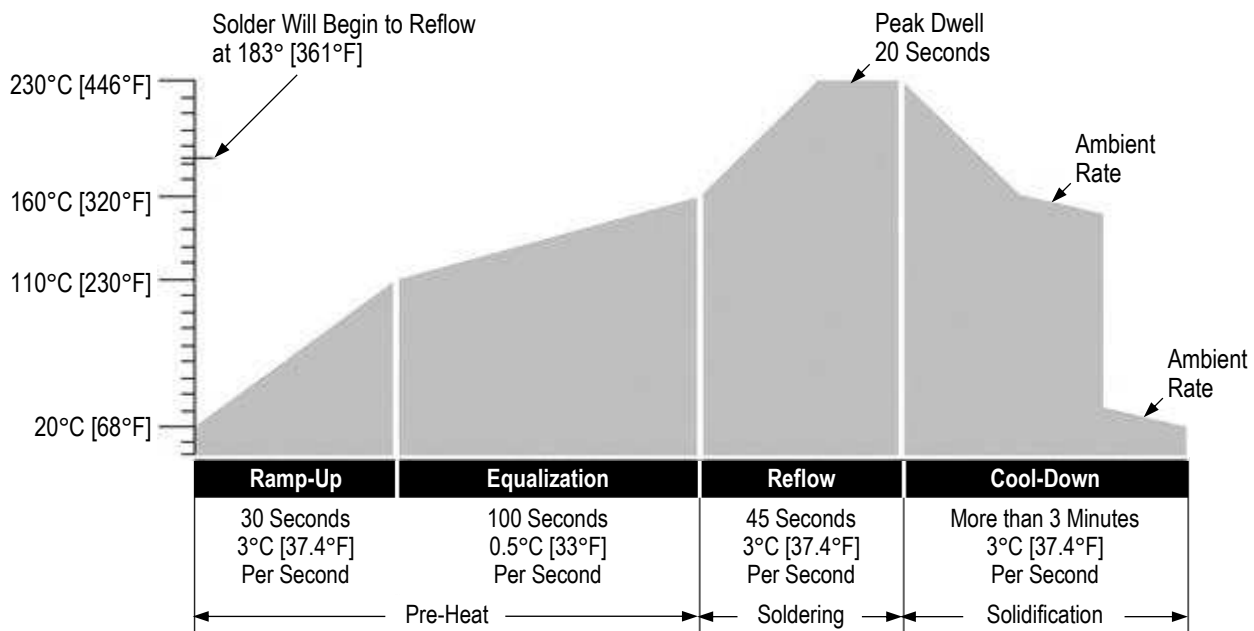

Lead-Free Solder
 (Maximum 260°C [500°F])

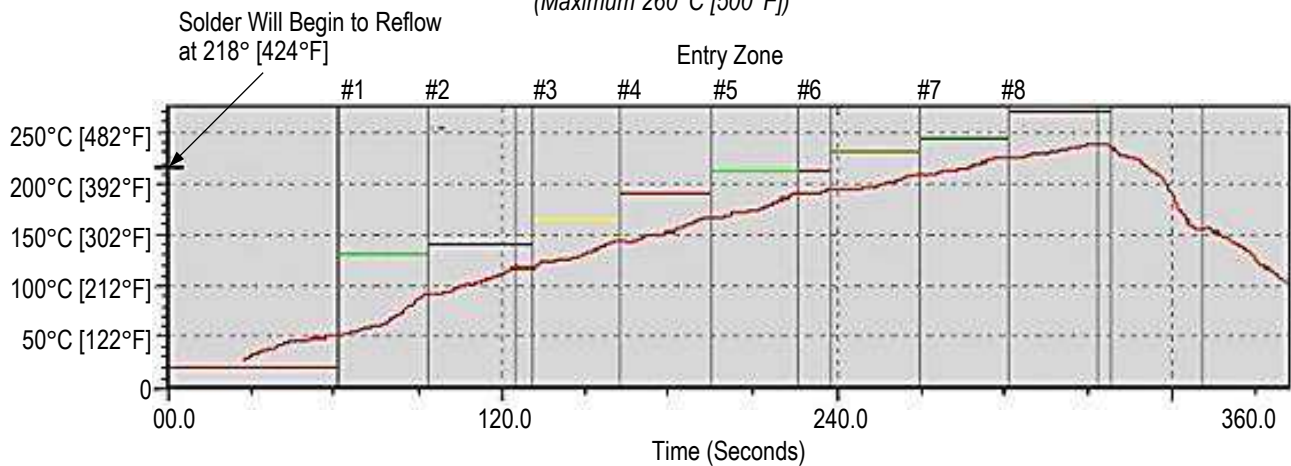

Figure 3

C. Solder Volume

Minimum solder volume (V) (before curing) for each circuit pad is calculated by multiplying the pad length (L) by the pad width (W) by the stencil thickness (T): $2.09(L) \times 0.35(W) \times 0.13(T) = 0.095 \text{ mm}^3 (V)$.



NOTE
Solder volume may vary depending on solder paste composition.

D. Solder Paste Thickness

Solder paste thickness for the connector contact solder tines must be at least 0.13.

E. Stencil

The stencil aperture is determined by the circuit pad size and stencil thickness. It may be any shape as long as it prevents solder bridging from one pad to another. The stencil should be 0.13 thick. The stencil layout must be designed using the dimension provided on the customer drawing for the specific connector.

F. Solder Mask

When soldering, solder mask is recommended between all circuit pads to minimize solder bridging between pads. The mask must not exceed the height of the pad. If a trace is run between adjacent pads on the pc board, a solder mask must be applied over the trace to prevent bridging and wicking of solder away from the connector contact solder tines. Mask most suitable is Liquid Photo Imageable.



CAUTION
Excessive temperatures may cause connector housing degradation or plating deterioration. It is recommended that component temperatures not exceed the temperatures and times given in Figure 3.

G. Cleaning

After soldering, removal of fluxes, residues, and activators is necessary. Consult with the supplier of the solder and flux for recommended cleaning solvents. Cleaners must be free of dissolved flux and other contaminants. It is recommended cleaning the pc board on its edge. If using aqueous cleaner, standard equipment such as a soak-tank or an automatic in-line machine should be used. Common cleaning solvents that will not affect this connector are listed in Figure 4.



DANGER
Consideration must be given to toxicity and other safety requirements recommended by the solvent manufacturer. Refer to the manufacturer's material safety data sheet (MSDS) for characteristics and handling of cleaners. Trichloroethylene and methylene chloride is not recommended because of harmful occupational and environmental effects. Both are carcinogenic (cancer-causing).



NOTE
If a particular cleaning solvent is not listed, contact product information at the number at the bottom of page 1 for advice.

CLEANER		TIME (Minutes)	TEMPERATURE (Max)
NAME	TYPE		
ALPHA 2110	Aqueous	1	132°C [270°F]
BIOACT EC-7	Solvent	5	100°C [212°F]
Butyl CARBITOL	Solvent	1	Ambient Room
Isopropyl Alcohol	Solvent	5	100°C [212°F]
KESTER 5778	Aqueous		
KESTER 5779	Aqueous		
LONCOTERGE 520	Aqueous		
LONCOTERGE 530	Aqueous		
Terpene	Solvent		

Figure 4

ALPHA, BIOACT, CARBITOL, KESTER, and LONCOTERGE are trademarks of their respective owners.

H. Drying

When drying cleaned assemblies and pc boards, temperature limitations must not be exceeded: 85° [185°F]. Excessive temperatures may cause connector housing degradation.

3.7. Connector Placement



CAUTION

Connectors should be handled only by the housing to avoid deformation, contamination, or damage to the contact solder tines.

Each contact solder tine must be seated on its pc board circuit pad. Optimally, the tines should be centered on the pc board circuit pads; however, slight misalignment is permissible.

Because the connector alignment posts are for clearance and fit only, the force required to seat the connector is minimal. The alignment posts must be inserted into the pc board holes and the standoffs must be seated on the pc board. Refer to Figure 5.

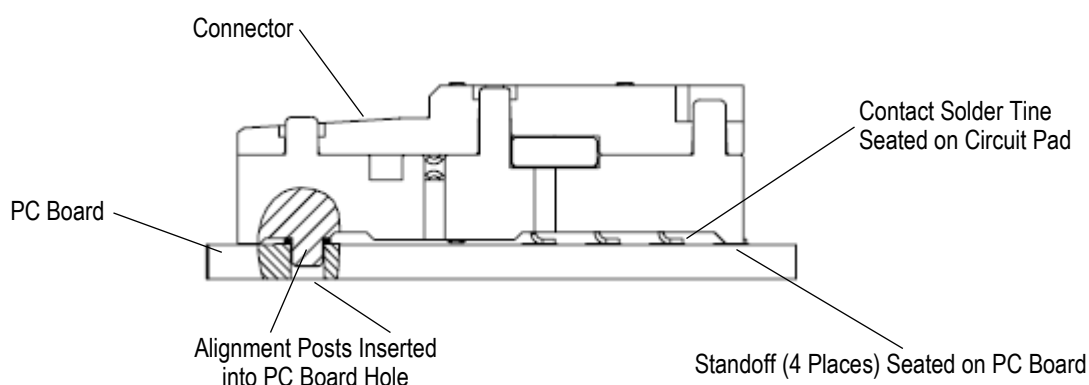

Figure 5

3.8. Checking Installed Connector

All solder joints must conform to the requirements specified in Workmanship Specification 101-21 and all other requirements specified in this document. The solder fillets must be evenly formed around each contact solder tine. Solder must have 95% minimum coverage over the circuit pad.

3.9. Removal and Repair

Standard de-soldering methods must be used to remove the connector from the pc board. The connector must not be re-used after removal. The connector is not repairable. Defective or damaged product must not be used.

4. QUALIFICATION

Agency evaluation for 40-position right-angle SFP-DD pc board connector was not defined at the time of publication of this application specification.

5. TOOLING

No tooling is required for manual placement of the connectors onto the pc board.

For automatic machine placement, the robotic equipment must have a true position accuracy tolerance sufficient to properly locate the connector. This includes gripper and fixture tolerances as well as equipment repeatability. It must use the connector datum surfaces given on the customer drawing to ensure reliable placement. When using a vacuum pick-and-place tool, the location of the centroid of the connector must meet the position given in Figure 6.

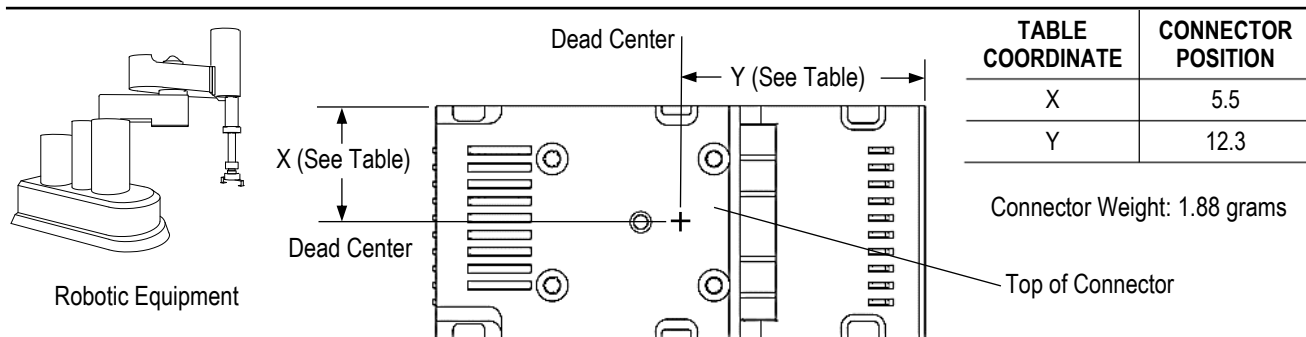

Figure 6

6. VISUAL AID

The illustration below shows a typical application of 40-position right-angle SFP-DD pc board connector. This illustration should be used by production personnel to ensure a correctly applied product. Applications which do not appear correct should be inspected using the information in the preceding pages of this specification and in the instructional material shipped with the product or tooling.

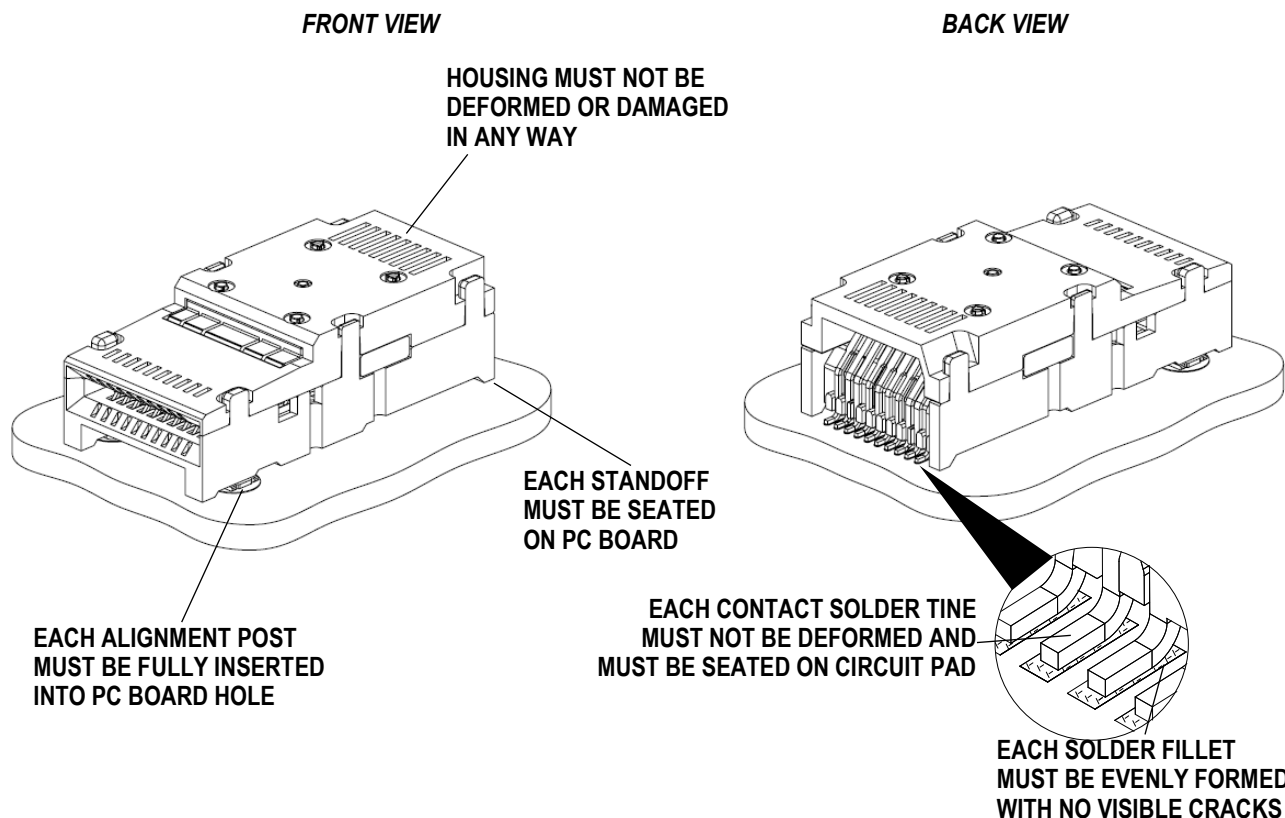

FIGURE 7. VISUAL AID