



TAOGLAS®



Datasheet

Part No:
GGSFTP.50.7.A.08

Description:
50*50*7mm Low Profile Terrablast Stacked Patch Antenna

Features:

- GPS/GLONASS/GALILEO with GPS L2 band Operation
- Single Feed Patch Assembly
- 4.6 dBi peak gain tuned for Centre Positioning on a 70*70mm Ground-plane
- Ultra-Impact Resistant
- Patent Pending Design
- Dimensions: 50*50*7mm
- RoHS & REACH Compliant

1. Introduction	3
2. Specifications	4
3. Antenna Characteristics	7
4. Radiation Patterns	10
5. Mechanical Drawing	14
6. PCB Footprint Recommendation	15
7. Soldering Recommendations	16
8. Packaging	17
<hr/>	
Changelog	18

Taoglas makes no warranties based on the accuracy or completeness of the contents of this document and reserves the right to make changes to specifications and product descriptions at any time without notice. Taoglas reserves all rights to this document and the information contained herein. Reproduction, use or disclosure to third parties without express permission is strictly prohibited.



1. Introduction



The GGSFTP.50.7.A.08 is a 50*50mm Terrablast GPS/GLONASS/GALILEO with GPS L2 low profile, embedded stacked passive patch antenna with 7mm thickness. The antenna has been tuned and tested on a 70*70mm ground plane, working at GPS 1575.42MHz, 1227.6MHz and GLONASS 1602MHz, with 4.3dBi gain, 2.6dBi gain and 4.6dBi gain, respectively.

The low-profile patch design also utilizes the Taoglas Terrablast material which provides a lightweight and robust solution for applications which require high impact resistance such as drones, ATVs and vehicles and is the ideal embedded solution for applications such as:

- Precision Transportation
- Tracking and Inventory Management
- Defense
- Marine
- Aviation
- Agriculture
- UAV Navigation
- Surveying
- Improved Weather forecasting

The GGSFTP.50.7.A.08 builds on the success of the groundbreaking series of high precision antennas by Taoglas and is an addition to the ongoing product roadmap. This antenna works well without modifications in most environment but can be tuned and further optimized to different ground planes and enclosures if this is required. Custom antenna modifications are subject to possible NRE and minimum order quantity.

Terrablast antennas are not suitable for SMD reflow. The correct method is manual soldering at a soldering temperature of 380°C +/- 20°C for a duration of 3 to 5 seconds. All Terrablast antennas undergo rigorous temperature, vibration and impact tests and exceed the highest ISO16750 standards.

For further information, or support to test and integrate Taoglas Terrablast technology please contact your regional Taoglas customer support team.

2. Specifications

GNSS Frequency Band							
GPS/QZSS	L1 1575.42MHz	L2 1227.6MHz	L5 1176.45MHz	L6 1278.75MHz			
	■	■	□	□			
GLONASS	L5R 1176.45MHz	L3PT 1201.5MHz	L2PT 1246MHz	L1CR 1575.42MHz	L1PT 1602MHz		
	□	□	■	■	■		
Galileo	E5a 1176.45MHz	E5b 1201.5MHz	E4 1215MHz	E3 1256MHz	E6 1278.75MHz	E2 1561MHz	L1 1575.42MHz
	□	■	□	□	□	■	■
BeiDou	B1 1561MHz	B2 1207.14MHz	B3 1268.52MHz				
	■	■	□				
Compass	E5B(B2)/ E6(B3) 1268.56MHz	E2(B1) 1561MHz					
	□	■					
SBAS	Omnistar 1542.5MHz	WAAS/EGN OS 1575.42MHz					
	□	■					

GNSS Electrical		
Frequency (MHz)	1575.42-1602	1227
Return Loss (dB)	-10dB max	-10dB max
Efficiency (%)	77	61
Peak Gain at Zenith (dBi)	4.6 typ	2.6 typ
Average Gain (dB)	-1.1	-2.1
Polarization	RHCP	
Impedance(Ω)	50	

Field Test Result with 70*70mm ground plane

Frequency	GPS L1	GPS L2	Galileo E1	Galileo E5b	GLONASS G1	GLONASS G2	BeiDou B1I	BeiDou B2I
	1563-1587	1215-1239.6	1559-1591	1189-1214	1598-1605	1242-1249	1559-1563	1200-1214
Carrier-to-Noise Values(dB-Hz)	38	31.66	35.5	31.33	34.25	27.125	34.66	31.33
2*DRMS Positioning Accuracy (cm) without RTK	95	95	95	95	95	95	95	95
2*DRMS Positioning Accuracy (cm) with RTK	8	8	8	8	8	8	8	8
TTF(s)	23.76	23.76	23.76	23.76	23.76	23.76	23.76	23.76
Group Delay @ Zenith Variation Across Single Constellation(ns)	1	4	1	4	1	4	1	4
Phase Centre Offset PCO (cm)	5	5.5	5	5.5	5	5.5	5	5.5
Phase Centre Variation PCV (mm)	0.3	0.4	0.3	0.4	0.3	0.4	0.3	0.4
Axial Ratio (dB)	3	6	3.5	18	6	6	6	18

*All outdoor measurements performed on the roof top of the Taoglas R&D Labs facility in Dublin Ireland.

** Recommended Minimum C/No for Standard Precision Acquisition/ Tracking (dB-Hz): 26-30/ 12-15.

***Data Measured Free Space.

****Group Delay, PCO, PCV and Axial Ratio values includes Active Circuitry.

*****Ublox C099-F9P application board is used for Field test Measurements.

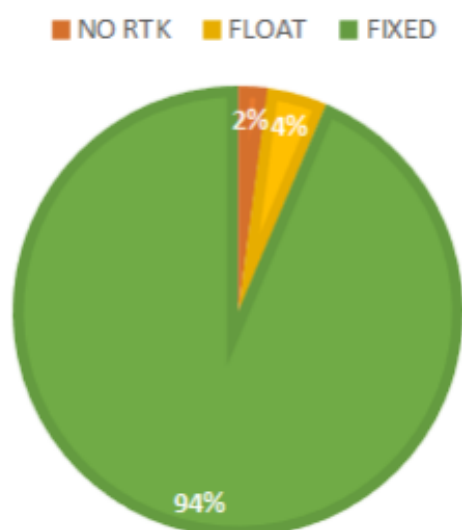

Mechanical	
Dimensions	50 x 50 x 7mm
Material	Terrablast
Pin Diameter	0.9mm
Pin Length	2.4mm
Weight	36.2g
Environmental	
Operation Temperature Range	-30°C to 85°C
Storage Temperature Range	-30°C to 95°C
Humidity	Non-condensing 65°C 95% RH

3. Antenna Characteristics

3.1 Return Loss

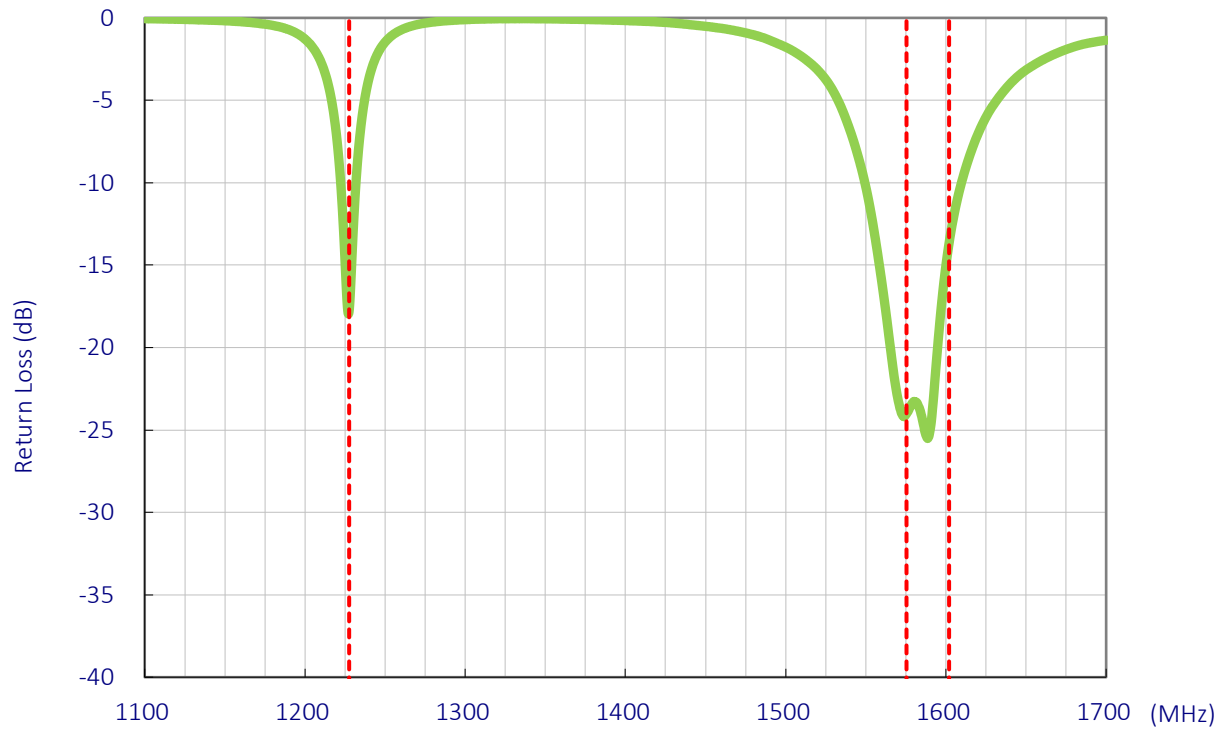

3.2 Efficiency

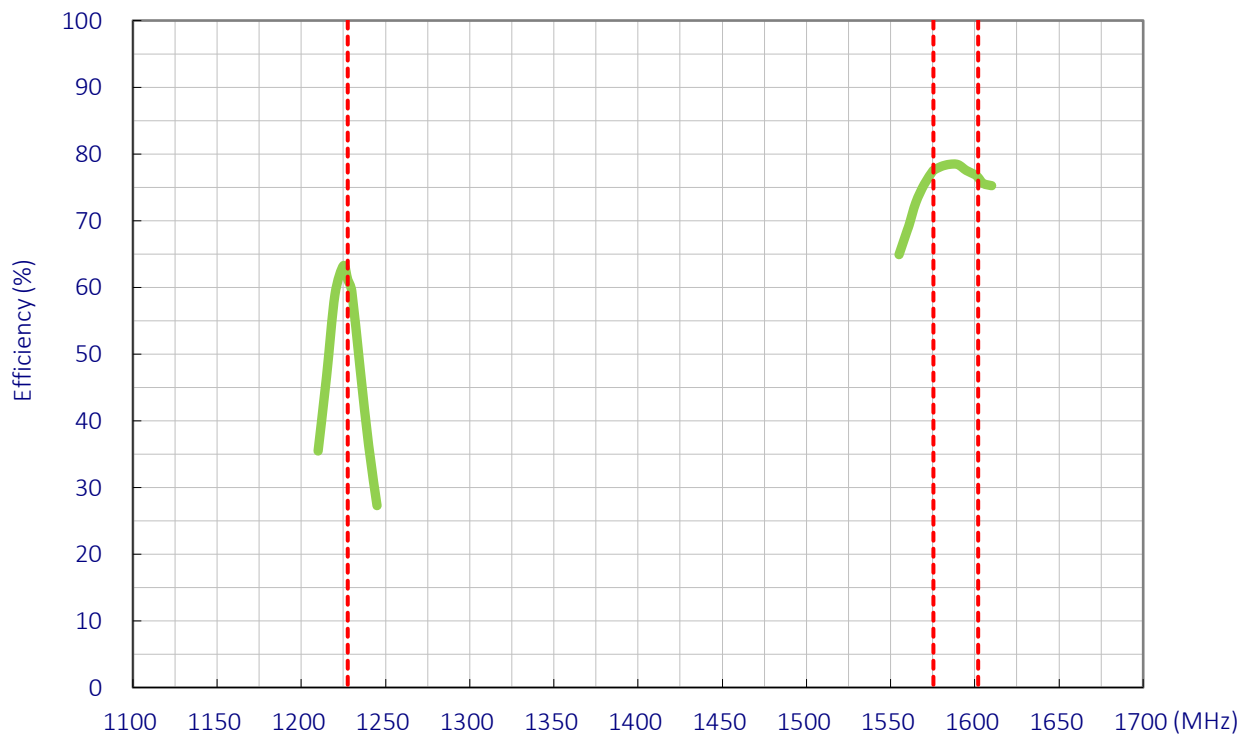

3.3 Average Gain

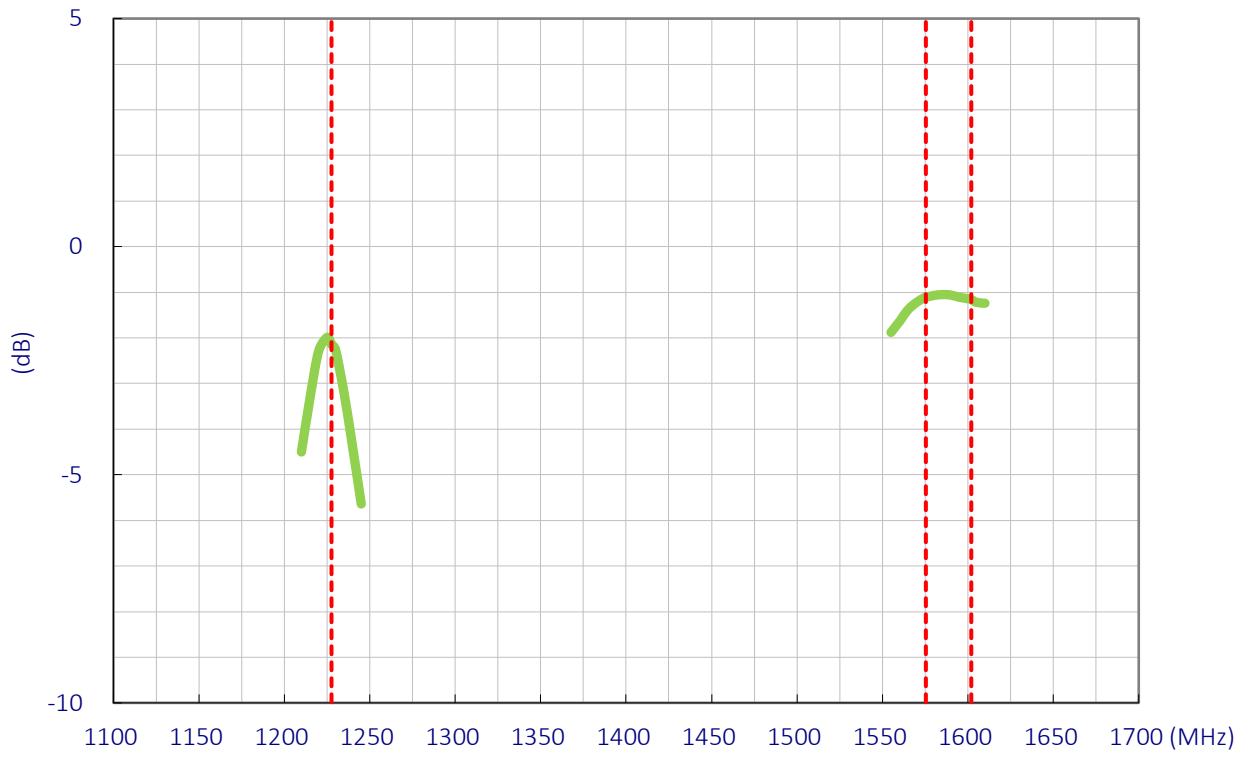

3.4 Peak Gain

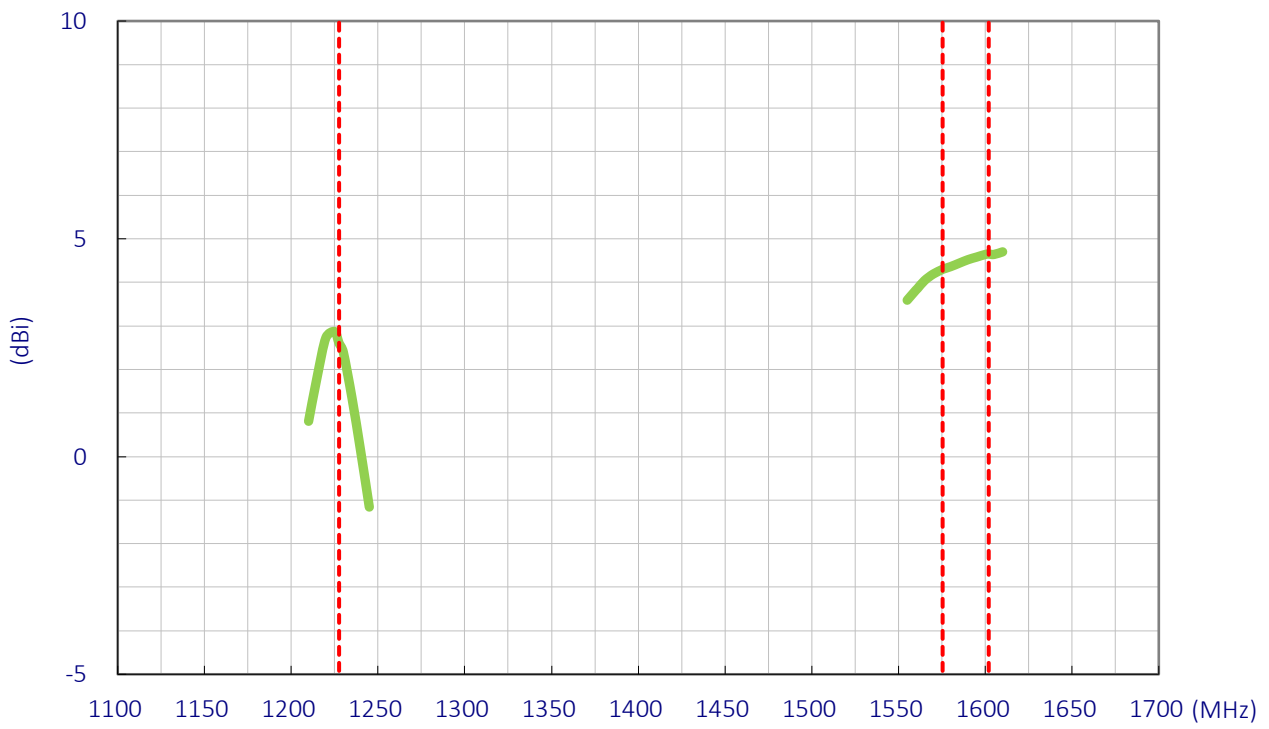

3.5 Axial Ratio @ 1575.42MHz

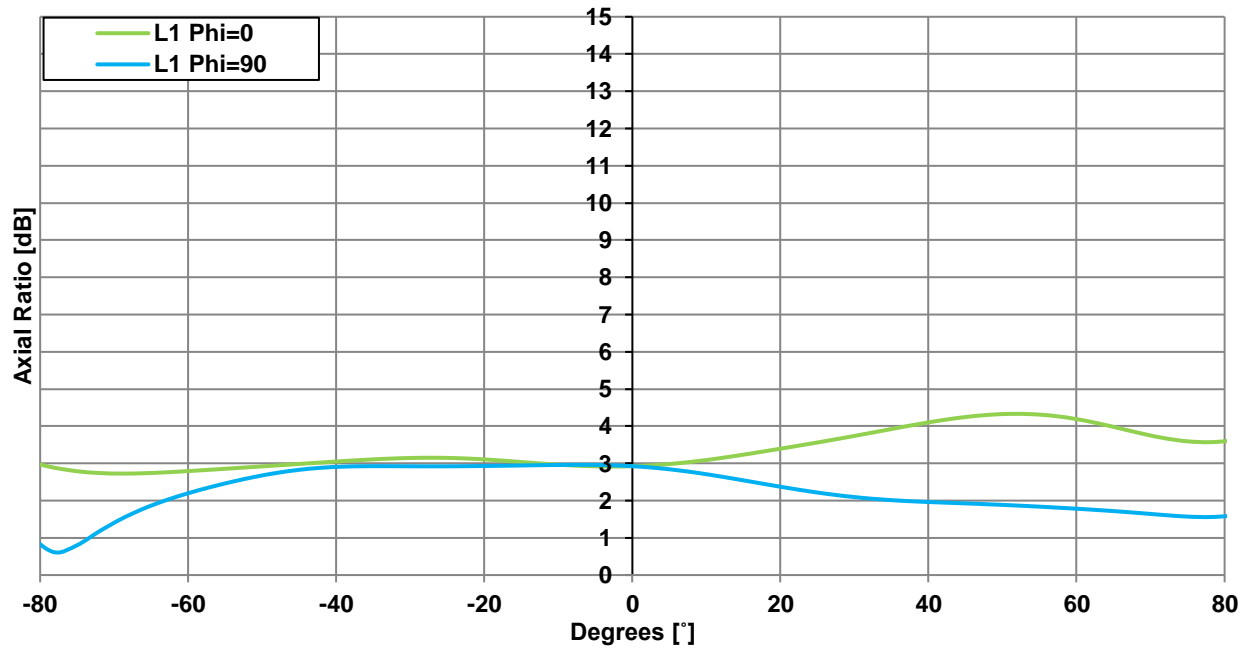

3.6 Axial Ratio @ 1227.6MHz

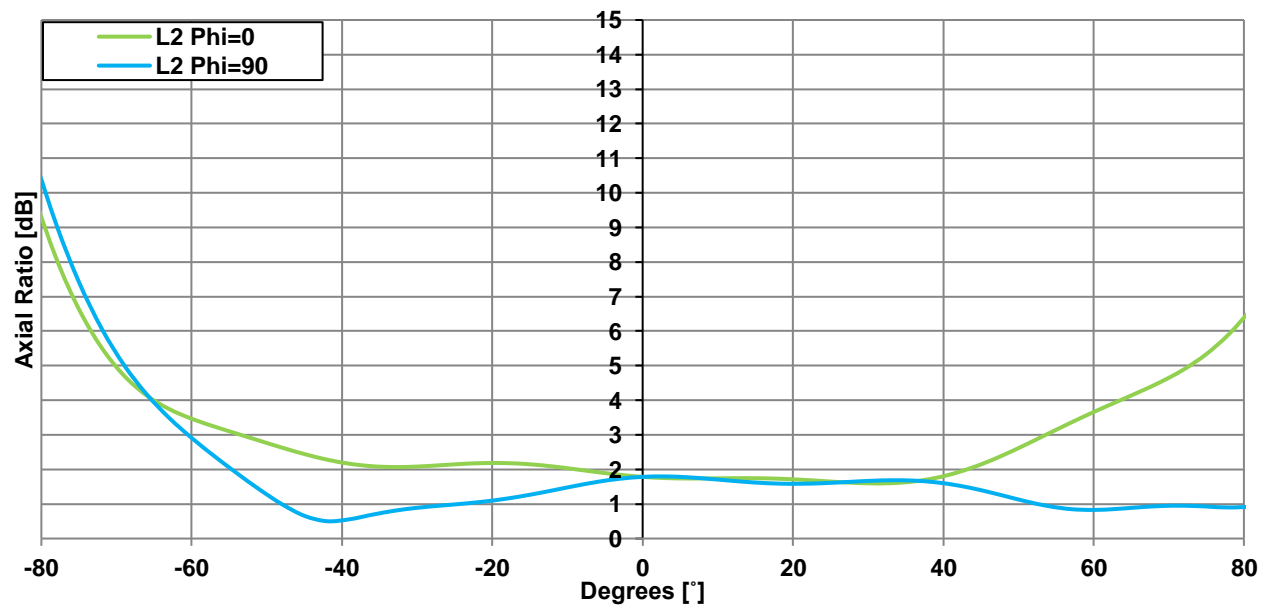

4. Radiation Patterns

4.1 Test Setup – on 70*70mm Ground Plane

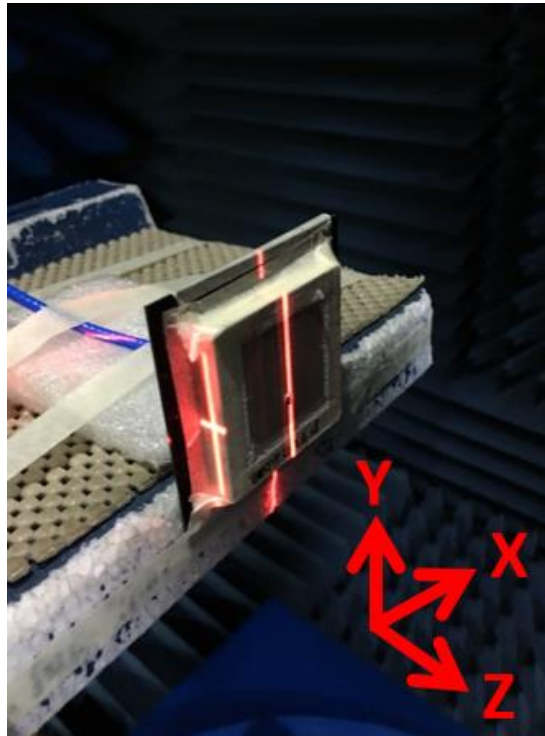

4.2 1227.6MHz 3D and 2D Radiation Patterns

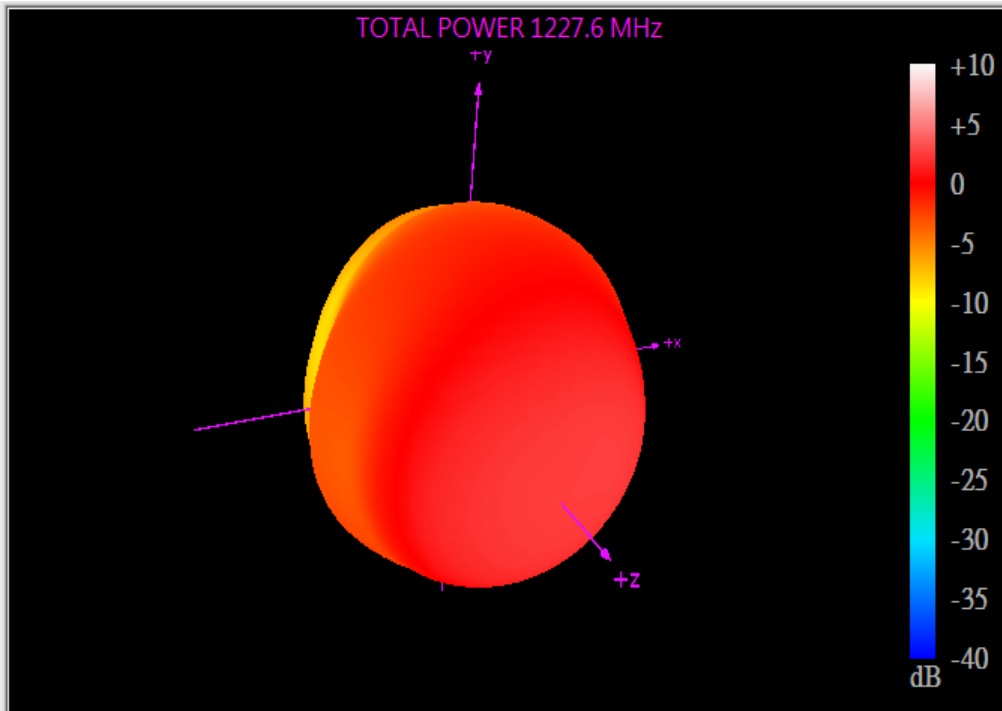

XY Plane XZ Plane YZ Plane

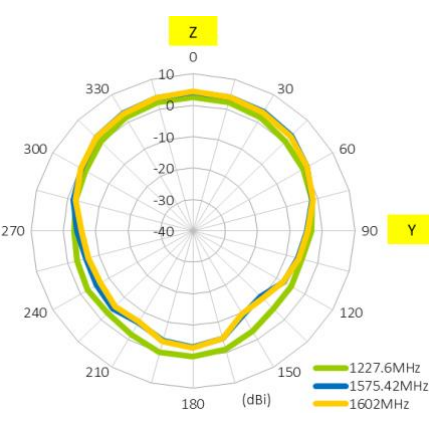
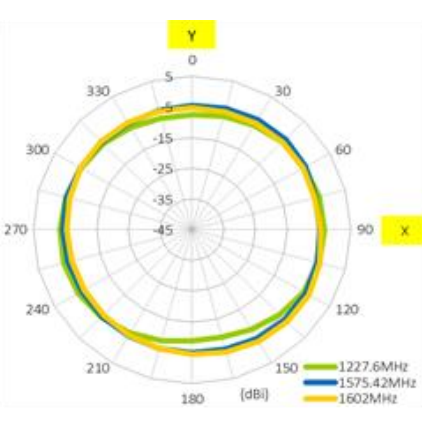
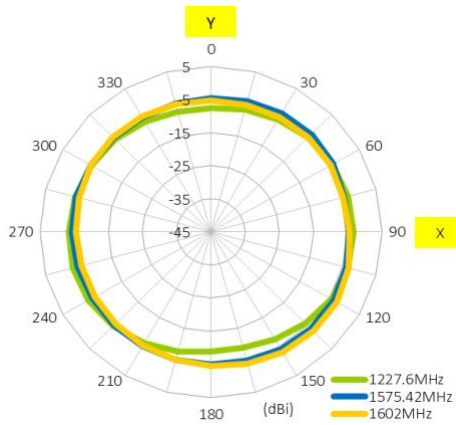

4.3 1575.42MHz 3D and 2D Radiation Patterns

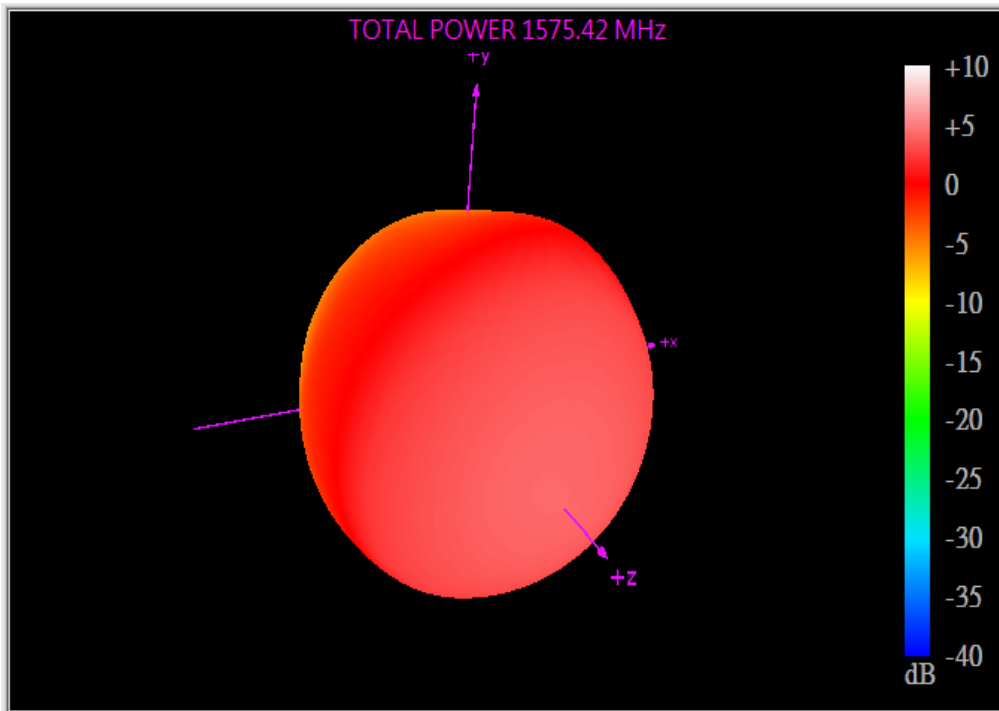

XY Plane

XZ Plane

YZ Plane

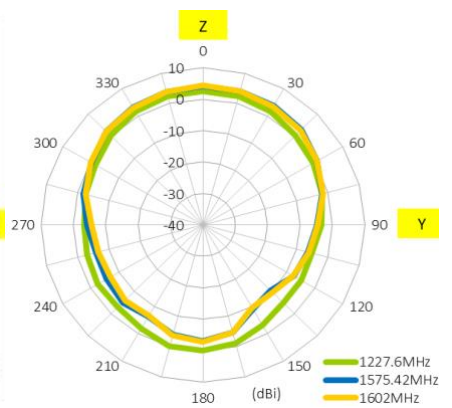
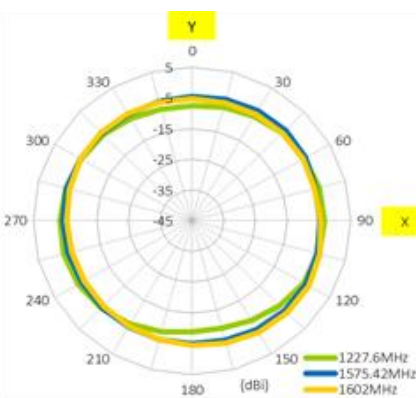
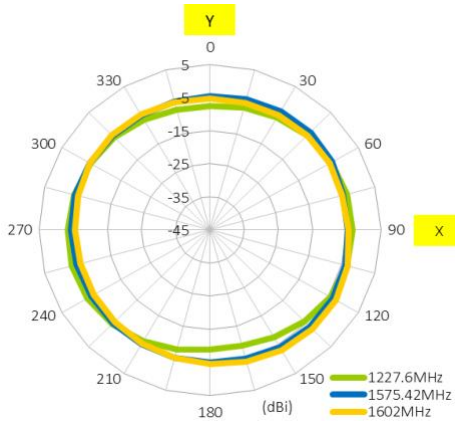

4.4 1602MHz 3D and 2D Radiation Patterns

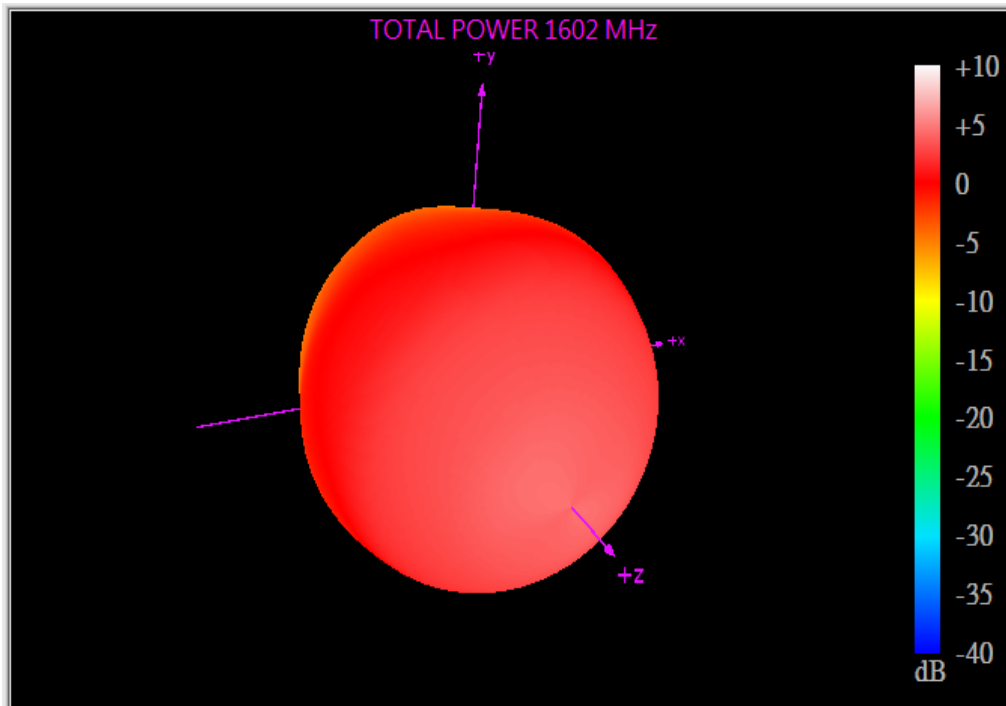

XY Plane

XZ Plane

YZ Plane

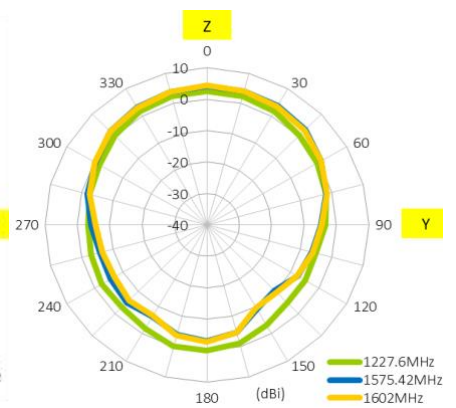
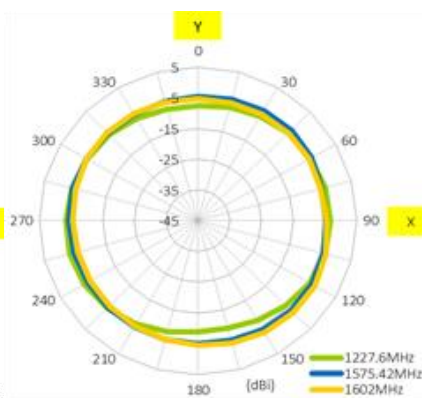
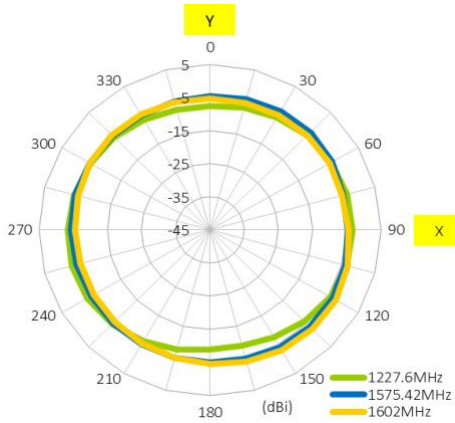

5. Mechanical Drawing (Units: mm)

ISO NO.: EDW-18-8-5030

STATE: Release

NOTES: 1. Double Sided Adhesive Area.

REV.	DESCRIPTION	ENG.	APPROVED	DATE
01	Initial Design	Alster	Haley	2018/08/15
02	EC-21-08-010	Mickey	Buluto	2021/03/02

Front View

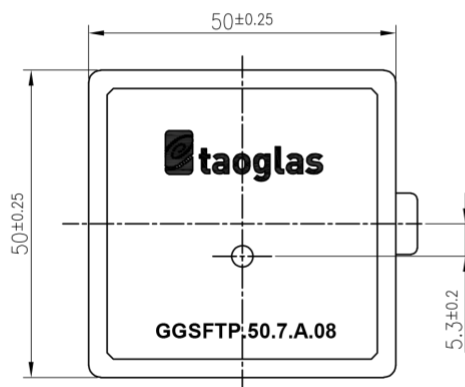

Side View

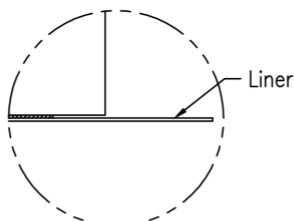
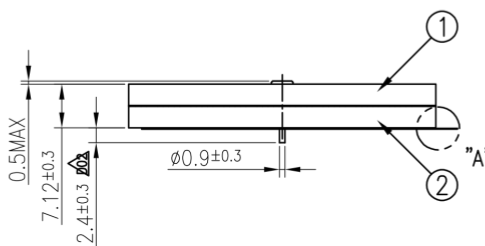

Detail A
Scale:4:1

Back View

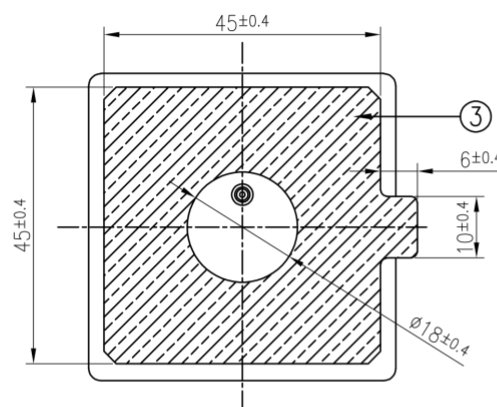

APPROVED BY: Haley	 <small>TW Design Centre</small> <small>This drawing and its inherent design concepts are property of Taoglas. Not to be copied or given to third parties without the written consent of Taoglas.</small>
CHECK BY: Jack/Amos	
DRAWN BY: Alster	
DATE: 2018/08/15	TITLE : Terrablast 50*50*7mm GPS L1,L2 & GLONASS Single Feed Patch Antenna
UNLESS OTHERWISE SPECIFIED TOLERANCES ON:	PART NO. : GGSFTP.50.7.A.08
THIRD ANGLE PROJECTION	UNIT: mm SCALE: 1:1 PAGES: 1/1 REV: D02

	Name	P/N	Material	Finish	QTY
1	Patch-1(50x50x3.5mm)	001518H110000A	Terrablast	Clear	1
2	Patch-2(50x50x3.5mm)	001518H120000A	Terrablast	Clear	1
3	Double sided Adhesive	001518H120000A	NIITO 5015	White Liner	1

6. PCB Footprint Recommendation

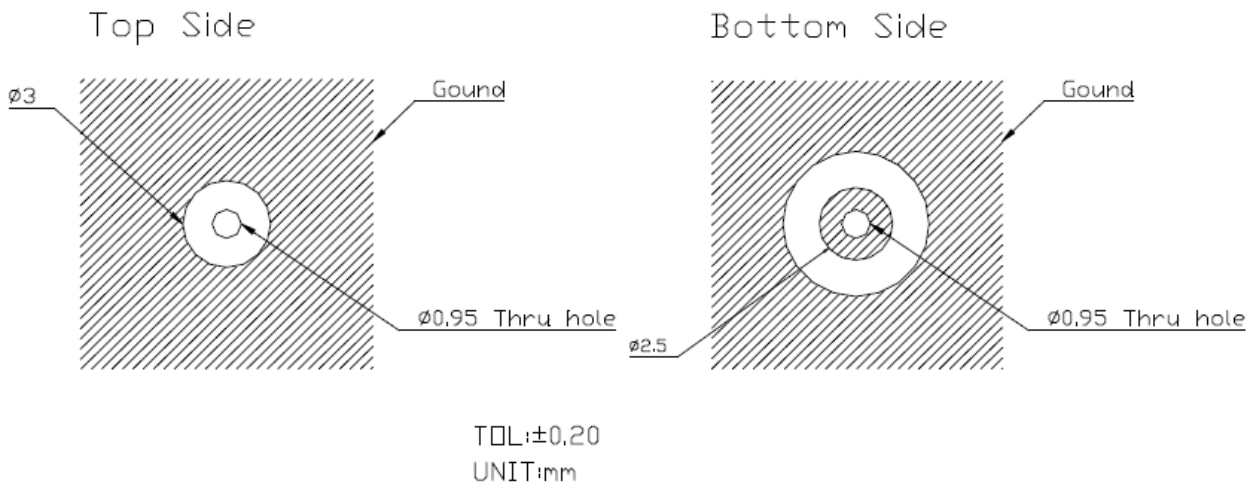

7. Soldering Recommendations

7.1 Manual Hand Soldering

Soldering Temperature: 360-380°C
Soldering Duration: 3~4 seconds

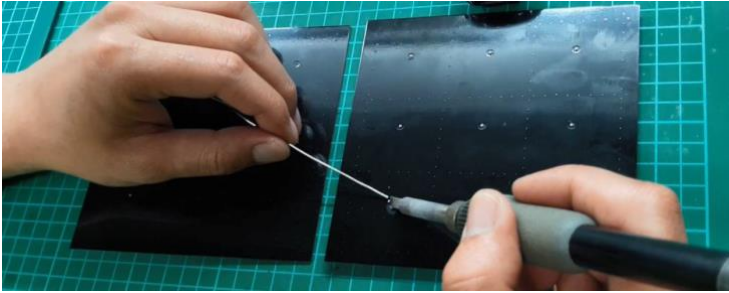

7.2 Automated Ferrochrome Soldering Machine

Soldering Temperature: 360-380°C
Soldering Duration: 3~4 seconds

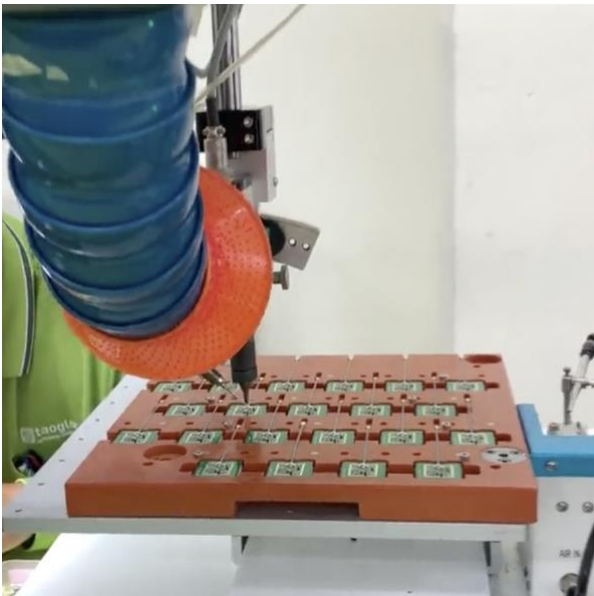

Please note that this process will require a one-time fixture to be made for each PCB design, Example as per image above.

8. Packaging

8 pcs GGSFTP.50.7.A.08 per Tray
 Tray Dimensions - 255*144*8mm
 Weight - 288g

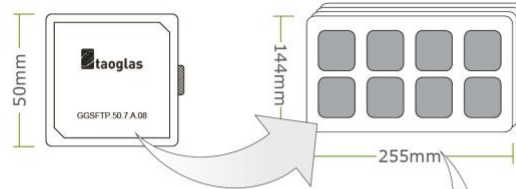

40 pcs GGSFTP.50.7.A.08 per Small Carton
 Carton Dimensions - 263*154*96mm
 Weight - 1.9kg

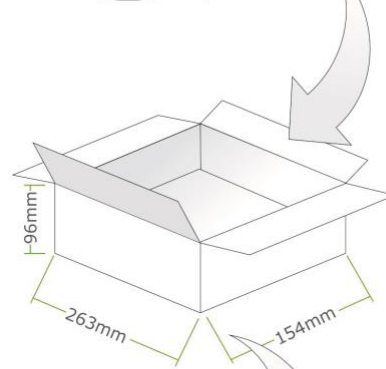

160 pcs GGSFTP.50.7.A.08 per Large Carton
 Large Carton Dimensions - 327*280*218mm
 Weight - 7.8kg

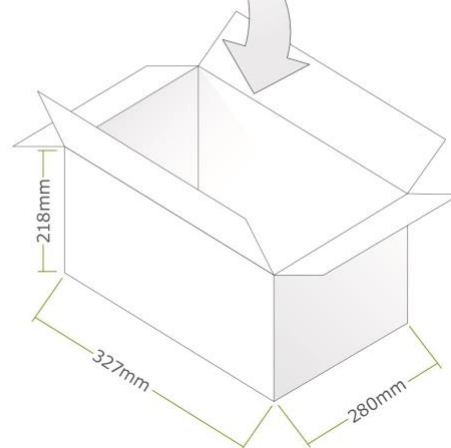

Pallet Dimensions:
 1200mm*1000mm*1280mm
 36 Cartons per Pallet
 9 Cartons per Layer, 4 Layers

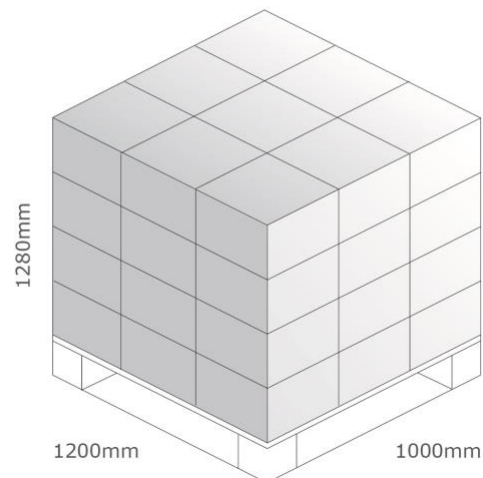

Changelog for the datasheet

SPE-18-8-092 – GGSFTP.50.7.A

Revision: E (Current Version)

Date:	2021-06-12
Changes:	Updated Pin Length to 2.4mm Updated Drawing
Changes Made by:	Dan Cantwell

Previous Revisions

Revision: D

Date:	2020-12-09
Changes:	Amended Soldering Recommendations.
Changes Made by:	Gary West

Revision: C

Date:	2020-03-19
Changes:	Updated Template and RTK data
Changes Made by:	Yu Kai Yeung

Revision: B

Date:	2018-10-22
Changes:	Update
Changes Made by:	Amos Huang

Revision: A (Original First Release)

Date:	2018-09-11
Notes:	Initial Datasheet Release
Author:	Jack Conroy



TAOGLAS®

www.taoglas.com