

DIN rail adapter - NBC-PP-G1PGY



1041740

<https://www.phoenixcontact.com/us/products/1041740>

Please be informed that the data shown in this PDF document is generated from our Online Catalog. Please find the complete data in the user documentation. Our General Terms of Use for Downloads are valid.



DIN rail adapter, type: Headers with shielding, degree of protection: IP20, material: PC-GF10, without assembled modules

Product Description

Compact DIN rail adapter with optional overall shielding braid, with dust protection cover, one-piece design

Commercial Data

Item number	1041740
Packing unit	1 pc
Minimum order quantity	1 pc
Sales Key	A08
Product Key	ABNAHA
Catalog Page	Page 375 (C-2-2019)
GTIN	4055626598666
Weight per Piece (including packing)	29.5 g
Weight per Piece (excluding packing)	29.4 g
Customs tariff number	85366990
Country of origin	DE

DIN rail adapter - NBC-PP-G1PGY

1041740

<https://www.phoenixcontact.com/us/products/1041740>

Technical Data

Notes

Notes on operation	without assembled modules
--------------------	---------------------------

Product properties

Product type	Patch panel
Set comprises	1100077 NBC-PP-J1PGY-S/R4IDC8
Number of module slots	1
Number of slots	1

Electrical properties

Contact resistance per contact pair	$\leq 5 \text{ m}\Omega$
Contact resistance	$\leq 5 \text{ m}\Omega$ (Shield-ground, optional)

Dimensions

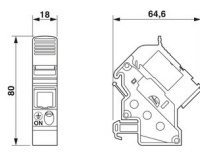
Dimensional drawing	
Width	18 mm
Height	80 mm
Depth	64.6 mm

Material specifications

Color	gray
Material	PP (Dust protection flap)
Flammability rating according to UL 94	V0
Contact material	CuSn6
Contact surface material	Tin
Housing material	PC-GF10

Environmental and real-life conditions

Ambient conditions

Degree of protection	IP20
Degree of protection	IP20
Ambient temperature (operation)	-10 °C ... 60 °C

Mounting

Mounting type	DIN rail mounting
Assembly instructions	Dust cover not compatible with FO module inserts

DIN rail adapter - NBC-PP-G1PGY

1041740

<https://www.phoenixcontact.com/us/products/1041740>



Drawings

Dimensional drawing

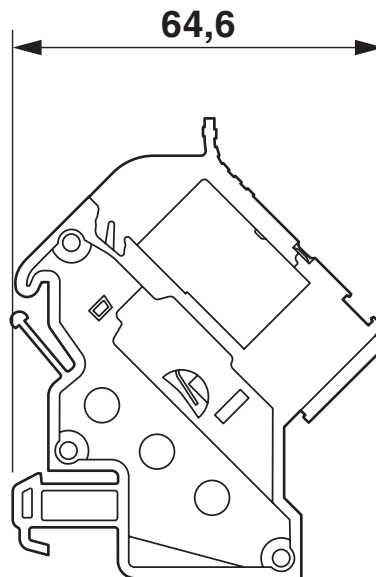
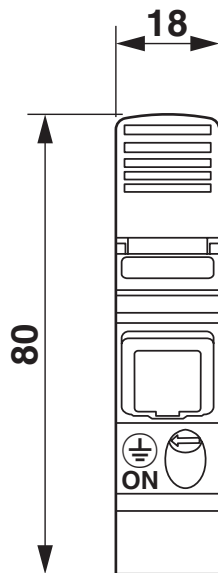

DIN rail adapter - NBC-PP-G1PGY



1041740

<https://www.phoenixcontact.com/us/products/1041740>

Classifications

ECLASS

ECLASS-9.0	27060308
ECLASS-10.0.1	27060308
ECLASS-11.0	27060308

ETIM

ETIM 8.0	EC002599
----------	----------

UNSPSC

UNSPSC 21.0	26121600
-------------	----------

DIN rail adapter - NBC-PP-G1PGY



1041740

<https://www.phoenixcontact.com/us/products/1041740>

Environmental Product Compliance

China RoHS	Environmentally friendly use period: unlimited = EFUP-e
	No hazardous substances above threshold values

DIN rail adapter - NBC-PP-G1PGY

1041740

<https://www.phoenixcontact.com/us/products/1041740>

Mandatory Accessories

RJ45 socket insert

RJ45 socket insert - CUC-I-J1ZNI-S/R4IDC8 - 1417274

<https://www.phoenixcontact.com/us/products/1417274>



RJ45 socket insert, type: RJ45, degree of protection: IP20, number of positions: 8, 10 Gbps, CAT6_A, material: Metal, connection method: IDC connection, connection cross section: AWG 26- 22, cable outlet: straight, Adapter-free design

RJ45 coupling

RJ45 coupling - CUC-I-D1ZNI-S/R4GC8 - 1041760

<https://www.phoenixcontact.com/us/products/1041760>

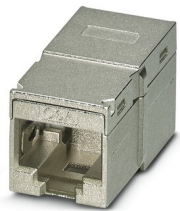

RJ45 coupling, degree of protection: IP20, number of positions: 8, 10 Gbps, CAT6_A, material: Metal, connection method: Coupling, Adapter-free design

DIN rail adapter - NBC-PP-G1PGY

1041740

<https://www.phoenixcontact.com/us/products/1041740>

Fiber optic coupling

Fiber optic coupling - FOC-I-D1PGN-S/LCGCSM - 1041780

<https://www.phoenixcontact.com/us/products/1041780>



Fiber optic coupling, type: LC, degree of protection: IP20, material: Plastic, connection method: Coupling, cable outlet: straight

Fiber optic coupling

Fiber optic coupling - FOC-I-D1PGR-S/SCGCSM - 1041800

<https://www.phoenixcontact.com/us/products/1041800>



Fiber optic coupling, type: SC, degree of protection: IP20, material: Plastic, connection method: Coupling, cable outlet: straight

DIN rail adapter - NBC-PP-G1PGY

1041740

<https://www.phoenixcontact.com/us/products/1041740>

Fiber optic coupling

Fiber optic coupling - FOC-I-D1PGY-S/MPAGC - 1041820

<https://www.phoenixcontact.com/us/products/1041820>



Fiber optic coupling, degree of protection: IP20, material: Plastic, connection method: Coupling, cable outlet: straight

Fiber optic coupling

Fiber optic coupling - FOC-I-D1PGY-S/MPBGC - 1041840

<https://www.phoenixcontact.com/us/products/1041840>



Fiber optic coupling, degree of protection: IP20, material: Plastic, connection method: Coupling, cable outlet: straight

Accessories

DIN rail adapter - NBC-PP-G1PGY

1041740

<https://www.phoenixcontact.com/us/products/1041740>

RJ45 socket insert

RJ45 socket insert - CUC-I-J1ZNI-S/R4IDC8 - 1417274

<https://www.phoenixcontact.com/us/products/1417274>

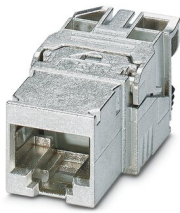

RJ45 socket insert, type: RJ45, degree of protection: IP20, number of positions: 8, 10 Gbps, CAT6_A, material: Metal, connection method: IDC connection, connection cross section: AWG 26- 22, cable outlet: straight, Adapter-free design

RJ45 coupling

RJ45 coupling - CUC-I-D1ZNI-S/R4GC8 - 1041760

<https://www.phoenixcontact.com/us/products/1041760>

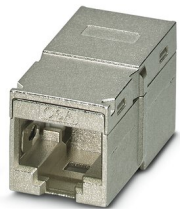

RJ45 coupling, degree of protection: IP20, number of positions: 8, 10 Gbps, CAT6_A, material: Metal, connection method: Coupling, Adapter-free design

DIN rail adapter - NBC-PP-G1PGY

1041740

<https://www.phoenixcontact.com/us/products/1041740>

Fiber optic coupling

Fiber optic coupling - FOC-I-D1PGY-S/MPAGC - 1041820

<https://www.phoenixcontact.com/us/products/1041820>

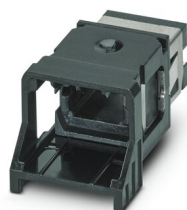

Fiber optic coupling, degree of protection: IP20, material: Plastic, connection method: Coupling, cable outlet: straight

Fiber optic coupling

Fiber optic coupling - FOC-I-D1PGY-S/MPBGC - 1041840

<https://www.phoenixcontact.com/us/products/1041840>



Fiber optic coupling, degree of protection: IP20, material: Plastic, connection method: Coupling, cable outlet: straight

DIN rail adapter - NBC-PP-G1PGY

1041740

<https://www.phoenixcontact.com/us/products/1041740>



Dust protection cover

Dust protection cover - NBC-PP-P1PGY:10 - 1041860

<https://www.phoenixcontact.com/us/products/1041860>

Dust protection cover



Plug Guard Security Frame

Plug Guard Security Frame - NBC-PP-F1PWH:10 - 1041881

<https://www.phoenixcontact.com/us/products/1041881>

Plug Guard Security Frame



DIN rail adapter - NBC-PP-G1PGY

1041740

<https://www.phoenixcontact.com/us/products/1041740>



Port Guard Security Element

Port Guard Security Element - NBC-PP-A1PRD:10 - 1041900

<https://www.phoenixcontact.com/us/products/1041900>



Port Guard Security Element

Marker for terminal blocks

Marker for terminal blocks - UC-TMF 16 - 0819262

<https://www.phoenixcontact.com/us/products/0819262>



Marker for terminal blocks, Sheet, white, unlabeled, can be labeled with: BLUEMARK ID COLOR, BLUEMARK ID, BLUEMARK CLED, PLOTMARK, CMS-P1-PLOTTER, mounting type: snapped, for terminal block width: 16 mm, lettering field size: 15.45 x 5.1 mm, Number of individual labels: 32

DIN rail adapter - NBC-PP-G1PGY

1041740

<https://www.phoenixcontact.com/us/products/1041740>



Marker for terminal blocks

Marker for terminal blocks - UC-TMF 16 CUS - 0824678

<https://www.phoenixcontact.com/us/products/0824678>



Marker for terminal blocks, can be ordered: by sheet, white, labeled according to customer specifications, mounting type: snap into flat marker groove, for terminal block width: 16 mm, lettering field size: 15.45 x 5.1 mm, Number of individual labels: 32

DIN rail perforated

DIN rail perforated - NS 35/ 7,5 PERF 1155MM - 1207666

<https://www.phoenixcontact.com/us/products/1207666>



DIN rail perforated, acc. to EN 60715, material: Steel, galvanized, passivated with a thick layer, Standard profile, color: silver

DIN rail adapter - NBC-PP-G1PGY

1041740

<https://www.phoenixcontact.com/us/products/1041740>



DIN rail adapter

DIN rail adapter - FL DIN RA - 2891053

<https://www.phoenixcontact.com/us/products/2891053>

The FL DIN RA is installed in a standard, 19-inch rack (EIA-310-D, IEC 60297-3-100) to allow DIN rail mounted equipment to be rack mounted.

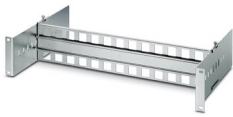

Fiber optic coupling

Fiber optic coupling - FOC-I-D1PGN-S/LCGCSM - 1041780

<https://www.phoenixcontact.com/us/products/1041780>

Fiber optic coupling, type: LC, degree of protection: IP20, material: Plastic, connection method: Coupling, cable outlet: straight



DIN rail adapter - NBC-PP-G1PGY

1041740

<https://www.phoenixcontact.com/us/products/1041740>

Fiber optic coupling

Fiber optic coupling - FOC-I-D1PGR-S/SCGCSM - 1041800

<https://www.phoenixcontact.com/us/products/1041800>



Fiber optic coupling, type: SC, degree of protection: IP20, material: Plastic, connection method: Coupling, cable outlet: straight

Marker for terminal blocks

Marker for terminal blocks - UC-TMF 16 VT - 0822699

<https://www.phoenixcontact.com/us/products/0822699>



Marker for terminal blocks, Sheet, violet, unlabeled, can be labeled with: BLUEMARK ID COLOR, BLUEMARK ID, BLUEMARK CLED, PLOTMARK, CMS-P1-PLOTTER, mounting type: snap in, for terminal block width: 16 mm, lettering field size: 15.45 x 5.1 mm, Number of individual labels: 32

DIN rail adapter - NBC-PP-G1PGY

1041740

<https://www.phoenixcontact.com/us/products/1041740>

Marker for terminal blocks

Marker for terminal blocks - UC-TMF 16 YE - 0819259

<https://www.phoenixcontact.com/us/products/0819259>



Marker for terminal blocks, Sheet, yellow, unlabeled, can be labeled with: BLUEMARK ID COLOR, BLUEMARK ID, BLUEMARK CLED, PLOTMARK, CMS-P1-PLOTTER, mounting type: snapped, for terminal block width: 16 mm, lettering field size: 15.45 x 5.1 mm, Number of individual labels: 32

Marker for terminal blocks

Marker for terminal blocks - UC-TMF 16 RD CUS - 0824682

<https://www.phoenixcontact.com/us/products/0824682>



Marker for terminal blocks, can be ordered: by sheet, red, labeled according to customer specifications, mounting type: snap into flat marker groove, for terminal block width: 16 mm, lettering field size: 15.45 x 5.1 mm, Number of individual labels: 32

DIN rail adapter - NBC-PP-G1PGY

1041740

<https://www.phoenixcontact.com/us/products/1041740>



Marker for terminal blocks

Marker for terminal blocks - UC-TMF 16 GN - 0817921

<https://www.phoenixcontact.com/us/products/0817921>



Marker for terminal blocks, Sheet, green, unlabeled, can be labeled with: BLUEMARK ID COLOR, BLUEMARK ID, BLUEMARK CLED, PLOTMARK, CMS-P1-PLOTTER, mounting type: snapped, for terminal block width: 16 mm, lettering field size: 15.45 x 5.1 mm, Number of individual labels: 32

Marker for terminal blocks

Marker for terminal blocks - UC-TMF 16 BU CUS - 0824679

<https://www.phoenixcontact.com/us/products/0824679>



Marker for terminal blocks, can be ordered: by sheet, blue, labeled according to customer specifications, mounting type: snap into flat marker groove, for terminal block width: 16 mm, lettering field size: 15.45 x 5.1 mm, Number of individual labels: 32

DIN rail adapter - NBC-PP-G1PGY

1041740

<https://www.phoenixcontact.com/us/products/1041740>

Marker for terminal blocks

Marker for terminal blocks - UC-TMF 16 OG - 0817811

<https://www.phoenixcontact.com/us/products/0817811>



Marker for terminal blocks, Sheet, orange, unlabeled, can be labeled with: BLUEMARK ID COLOR, BLUEMARK ID, BLUEMARK CLED, PLOTMARK, CMS-P1-PLOTTER, mounting type: snapped, for terminal block width: 16 mm, lettering field size: 15.45 x 5.1 mm, Number of individual labels: 32

Marker for terminal blocks

Marker for terminal blocks - UC-TMF 16 OG CUS - 0824681

<https://www.phoenixcontact.com/us/products/0824681>



Marker for terminal blocks, can be ordered: by sheet, orange, labeled according to customer specifications, mounting type: snap into flat marker groove, for terminal block width: 16 mm, lettering field size: 15.45 x 5.1 mm, Number of individual labels: 32

DIN rail adapter - NBC-PP-G1PGY

1041740

<https://www.phoenixcontact.com/us/products/1041740>

Marker for terminal blocks

Marker for terminal blocks - UC-TMF 16 VT CUS - 0824683

<https://www.phoenixcontact.com/us/products/0824683>



Marker for terminal blocks, can be ordered: by sheet, violet, labeled according to customer specifications, mounting type: snap into flat marker groove, for terminal block width: 16 mm, lettering field size: 15.45 x 5.1 mm, Number of individual labels: 32

Marker for terminal blocks

Marker for terminal blocks - UC-TMF 16 BU - 0817905

<https://www.phoenixcontact.com/us/products/0817905>



Marker for terminal blocks, Sheet, blue, unlabeled, can be labeled with: BLUEMARK ID COLOR, BLUEMARK ID, BLUEMARK CLED, PLOTMARK, CMS-P1-PLOTTER, mounting type: snapped, for terminal block width: 16 mm, lettering field size: 15.45 x 5.1 mm, Number of individual labels: 32

DIN rail adapter - NBC-PP-G1PGY

1041740

<https://www.phoenixcontact.com/us/products/1041740>

Marker for terminal blocks

Marker for terminal blocks - UC-TMF 16 YE CUS - 0824684

<https://www.phoenixcontact.com/us/products/0824684>



Marker for terminal blocks, can be ordered: by sheet, yellow, labeled according to customer specifications, mounting type: snap into flat marker groove, for terminal block width: 16 mm, lettering field size: 15.45 x 5.1 mm, Number of individual labels: 32

Marker for terminal blocks

Marker for terminal blocks - UC-TMF 16 GN CUS - 0824680

<https://www.phoenixcontact.com/us/products/0824680>



Marker for terminal blocks, can be ordered: by sheet, green, labeled according to customer specifications, mounting type: snap into flat marker groove, for terminal block width: 16 mm, lettering field size: 15.45 x 5.1 mm, Number of individual labels: 32

DIN rail adapter - NBC-PP-G1PGY



1041740

<https://www.phoenixcontact.com/us/products/1041740>

Marker for terminal blocks

Marker for terminal blocks - UC-TMF 16 RD - 0817824

<https://www.phoenixcontact.com/us/products/0817824>



Marker for terminal blocks, Sheet, red, unlabeled, can be labeled with: BLUEMARK ID COLOR, BLUEMARK ID, BLUEMARK CLED, PLOTMARK, CMS-P1-PLOTTER, mounting type: snapped, for terminal block width: 16 mm, lettering field size: 15.45 x 5.1 mm, Number of individual labels: 32

Phoenix Contact 2022 © - all rights reserved

<https://www.phoenixcontact.com>

Phoenix Contact USA
586 Fulling Mill Road
Middletown, PA 17057, United States
(+717) 944-1300
info@phoenixcon.com