

IEC Appliance Inlet C14 with Circuit Breaker TA35 2-pole



Rocker white
Non-illuminated



Rocker green
illuminated



Rocker orange
illuminated



See below:
[Approvals and Compliances](#)

Description

- Panel mount :
Snap-in version front side
- 2 Functions :
Appliance Inlet , Protection class I , Circuit breaker type TA35 , 2-pole
- Quick connect terminal 6.3 x 0.8 mm

Characteristics

- Unwired
- Switch non-illuminated or illuminated
- Suitable for use in equipment according to IEC/UL 62368-1

Other versions on request

- Pre-wired version
- Quick connect terminals 4.8 x 0.8 mm
- Protection class II, 70°C

References

Alternative: version for 16 A (20 A)
 Component: circuit breakers [TA35 Rocker 2Pole](#); [TA36 Rocker](#)
 Substitute for type [7764](#)
 We recommend for new applications the type [DG11](#)

Weblinks

[pdf data sheet](#), [html datasheet](#), [General Product Information](#), [Approvals](#), [Distributor-Stock-Check](#), [Accessories](#), [Detailed request for product](#)

Newly available variants corresponding to V-Lock mating cordset. The connector is equipped with a notch intended for use with the latching cordset. The cord latching system prevents against accidental removal of the cordset.

Technical Data

Ratings IEC	10 A / 250 VAC; 50 Hz
Ratings UL/CSA	15 A / 250 VAC; 60 Hz
Dielectric Strength	> 2.5 kVAC between L-N > 3 kVAC between L/N-PE (1 min/50 Hz)
Allowable Operation Temperature	-25 °C to 60 °C
IP-Protection	front side IP40 acc. to IEC 60529
Protection against electric shock	Suitable for appliances with protection class I acc. to IEC 61140
Terminal	Quick connect terminals 6.3 x 0.8 mm
Panel Thickness S	Snap-in 1.5/2/2.5 mm
Material: Housing	Thermoplastic, black, UL 94V-0

Appliance inlet/-outlet	C14 acc. to IEC 60320-1 UL 60320-1, CSA C22.2 no. 60320-1 (for cold conditions) pin-temperature 70 °C, 10A, Protection Class I
Circuit Breakers	Acc. IEC/EN 60934, UL 1077, CSA 22.2 no. 235 2-pole rocker switch, illuminated or non-illuminated. Conditional short circuit Inc: 2000 A

Approvals and Compliances



Detailed information on product approvals, code requirements, usage instructions and detailed test conditions can be looked up in [Details about Approvals](#)

SCHURTER products are designed for use in industrial environments. They have approvals from independent testing bodies according to national and international standards. Products with specific characteristics and requirements such as required in the automotive sector according to IATF 16949, medical technology according to ISO 13485 or in the aerospace industry can be offered exclusively with customer-specific, individual agreements by SCHURTER.

Approvals



The approval mark is used by the testing authorities to certify compliance with the safety requirements placed on electronic products.

Approval Reference Type: 6135

Approval Logo	Certificates	Certification Body	Description
	VDE Approvals	VDE	Certificate Number: 40023066
	UL Approvals	UL	UL File Number: E96454
	CCC Approvals	CCC	CCC Certificate Number: 2020180204013718

Product standards

Product standards that are referenced

Organization	Design	Standard	Description
	Designed according to	IEC 60320-1	Appliance couplers for household and similar general purposes
	Designed according to	UL 60320-1	Standard for Attachment Plugs and Receptacles
	Designed according to	CSA C22.2 no. 60320-1	General Use Receptacles, Attachment Plugs, and Similar Wiring Devices







Application standards

Application standards where the product can be used

Organization	Design	Standard	Description
	Designed for applications acc.	IEC/UL 62368-1	Audio/video, information and communication technology equipment - Part 1: Safety requirements

Compliances

The product complies with following Guide Lines

Identification	Details	Initiator	Description
	CE declaration of conformity	SCHURTER AG	The CE marking declares that the product complies with the applicable requirements laid down in the harmonisation of Community legislation on its affixing in accordance with EU Regulation 765/2008.
	UKCA declaration of conformity	SCHURTER AG	The UKCA marking declares that the product complies with the applicable requirements laid down in the British Amendment of Regulation (EC) 765/2008.
	RoHS	SCHURTER AG	Directive RoHS 2011/65/EU, Amendment (EU) 2015/863
	China RoHS	SCHURTER AG	The law SJ / T 11363-2006 (China RoHS) has been in force since 1 March 2007. It is similar to the EU directive RoHS.
	REACH	SCHURTER AG	On 1 June 2007, Regulation (EC) No 1907/2006 on the Registration, Evaluation, Authorization and Restriction of Chemicals 1 (abbreviated as "REACH") entered into force.
		SCHURTER AG	V-Lock system are based on a matching plug-dose combination. The connector is equipped with a notch intended for use with the latching cordset. The cord latching system prevents against accidental removal of the cordset.

Dimensions [mm]

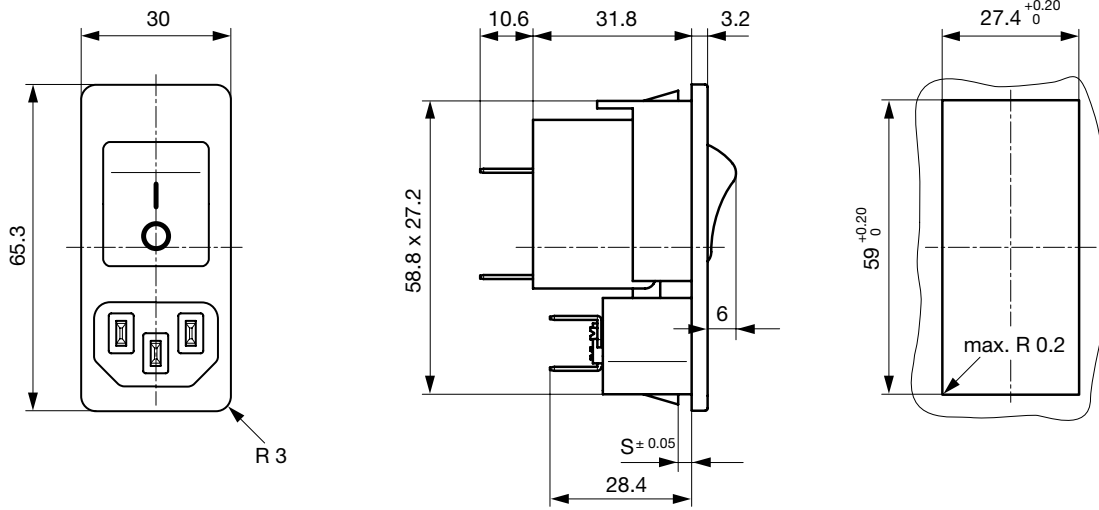

Diagrams

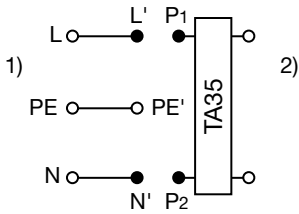

- 1) Line
- 2) Load

Effect of ambient temperature

The units are calibrated for an ambient temperature of +23°C. To determine the rated current for a lower or higher ambient temperature, use a correction factor (typical value) from the table below:

Ambient Temperature [°C]	Correction factor
-10	0.89
-5	0.91
0	0.92
+23	1.00
+30	1.03
+40	1.08
+55	1.16

Example: Rated current at +23°C 10 A, Ambient temperature +60°C, Correction factor 1.06, Chosen rated current at +60°C, ambient temperature: 10 A x 1.06 = 10.6 A

Time-Current-Curves

Tripping Characteristics $I_n < 3 A$

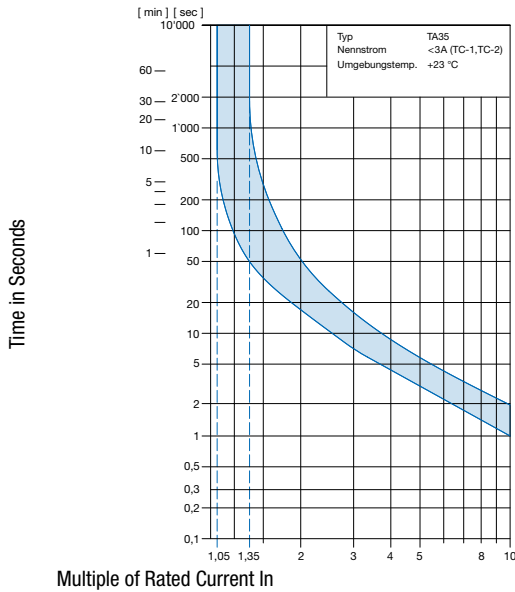

Multiple of Rated Current In

Reference Temperature +23°

Tripping Characteristics $I_n \geq 3 \dots \leq 15 A$

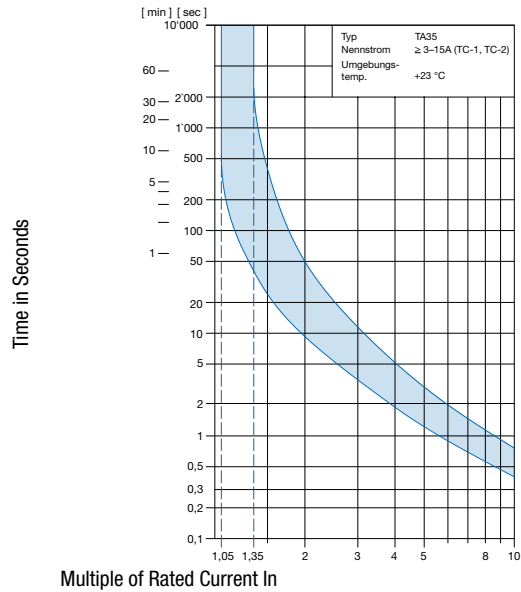

Multiple of Rated Current In

Reference Temperature +23°

Configuration code TA35

Typ	Konfigurationscode TA35										
6135	C	B	D	W	F	1	2	0	C	0	000-C6135-1112-100

No other features

Rated current I_n (A)

I_n	Code	I_n	Code
1,0	J10	8,0	080
2,0	J20	10,0	100
4,0	040	12,0	120*
5,0	050	15,0	150*
6,0	060		

Other rated currents on request

*) UL / CSA only

Rocker legend

Surface	Illustration	Colour of print	Position of the rocker legend e.g. F
F embossed			
H printed		white	
K printed		black	
L printed		white	
M printed		black	

Other legends on request

Colours

	Switch front	Rocker non-illuminated	illuminated
W	black	white	-
B	black	black	-
3	black	-	red transparent
4	black	-	green transparent
6	black	-	orange transparent

Other colours on request

Number of switched poles
 Number of protected poles

2-pole

		1	2
Switch	without illumination	CBT	CBD
Switch	illuminated 240 V 120 V	C12 C14	C32 C34

Other versions on request

Configuration code (Order example)

Typ	Konfigurationscode TA35
6135	- C B D W F 1 2 0 C 0 - 000-C6135-1112-100

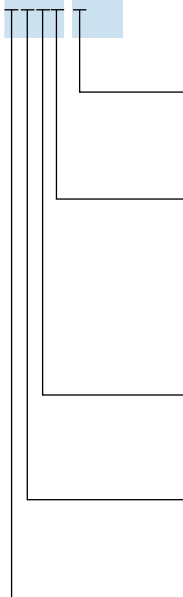

Locking system

- 0 Without
- 1 V-Lock

Mounting

- 1 Snap-in s = 1.0 mm 1)
- 2 Snap-in s = 1.5 mm
- 3 Snap-in s = 2.0 mm
- 4 Snap-in s = 2.5 mm
- 5 Snap-in s = 3.0 mm

Terminal PE

- 0 Without (PCI) 2)
- 1 Quick connect 6.3 x 0.8 mm

Terminal N

- 1 Quick connect 6.3 x 0.8 mm
- 4 Connection

Terminal L

- 1 Quick connect 6.3 x 0.8 mm
- 4 Connection

1) Only on request
 2) Only on request- no approvals available

0 Protection class 1

Packaging unit

40 Pcs

Accessories

Description



Assorted Covers
 Rear Cover

0859.0074



RC320
 Rear Cover for Power Entry Module



Cord retaining kits
 Cord retaining strain relief

Flat head, A

4700.0001

Mating Outlets/Connectors

Category / Description

Appliance Outlet Overview complete



4787, Mounting: Screw-on mounting, Appliance Outlet: IEC Solder terminals, 10 A, Suitable for appliances with protection class I

4787

4788, Mounting: Snap-in version, Appliance Outlet: IEC Solder / Quick Connect, 10 A, Suitable for appliances with protection class I

4788

Connector Overview complete



4782 Mounting: Power Cord, 3 x 1 mm² / 3 x 18 AWG, Cable, Connector: IEC C13

4782

4785 Mounting: Power Cord, 3 x 1 mm² / 3 x 18 AWG, Cable, Connector: IEC C13

4785

4300-06 Mounting: Power Cord, 3 x 1 mm² / 3 x 18 AWG, Cable, Connector: IEC C13

4300-06

4781 Mounting: Power Cord, Cable, Connector: IEC C15

4781

4784 Mounting: Power Cord, 3 x 1 mm² / 3 x 18 AWG, Cable, Connector: IEC C15

4784

...

Mating Outlets/Connectors shuttered

[Connector Overview complete](#)4783 Mounting: Power Cord, 3 x 1 mm² / 3 x 18 AWG, Cable, Connector: IEC C13

4783

[Power Cord Overview complete](#)

VAC13KS, Overview, V-Lock cord retaining, diverse Connector IEC C13, diverse, black

VAC13KS