

Type 3AG

Fast Blow Fuse Series

HF  3AG Series, 6x32mm Glass Tube Fast Blow Fuse

RoHS Compliant

Description

6x32mm Fast Blow, glass tube body cartridge fuse designed, approved and complied with UL and CSA standard 248-14.



Features

- Meet UL and CSA standard 248-14
- Wide operating temperature range
- Bulk packing available
- Full compliance with EU Directive 2011/65/EU and amending directive 2015/863
- Halogen Free
- Lead Free

Applications



Provide individual protection for components or internal circuits.

- Power supplies
- Battery charger
- Monitor
- Adapter

LEAD FREE = 
 HALOGEN FREE = 





Physical Specifications

Materials	Body : Glass
	Cap : Nickel Plated Brass Caps
	Leads : Matte Tin Plated Copper
Marking	On Fuse : "bel", "3AG", "Current Rating", "Voltage Rating", "Appropriate Safety Logos", "✓" (RoHS compliant)
	On Label :
	"bel", "3AG", "Current Rating", "Voltage Rating", "Interrupting Rating", "Appropriate Safety Logos" and "  ", "  "(China RoHS compliant).

Electrical Characteristics (UL/CSA STD.248-14)

Testing Current	Blow Time	
	Minimum	Maximum
100%	4 hrs.	N/A
135%	N/A	1 hr.
200%	N/A	5 sec

Safety Agency Approvals



Safety Agency	Safety Agency Certificate	Ampere Rating/ Voltage Rating	Ampere Range / Volt @ I.R. ability*
	E20624	500mA-10A/ 250V AC	500mA-10A/250V AC@200A 500mA-15A/125V AC@10,000A
	LR39772		
	JET1037-31003-1010	12A-15A/ 125V AC	1A-5A/125V AC@500A >5A-15A/125V AC@300A
	JET1037-31003-1011		
	JET1037-31003-1007		

*I.R.= Interrupting Rating = Short Circuit Rating(Amps)

Environmental Specifications

Shock Resistance	MIL-STD-202G, Method 213B, Test Condition 1 (100 G's peak for 6 milliseconds; Sawtooth waveform)
Vibration Resistance	MIL-STD-202G, Method 201A (10-55 Hz, 0.06 inch, total excursion).
Salt Spray Resistance	MIL-STD-202G, Method 101E, Test Condition B (48 hrs).
Insulation Resistance	MIL-STD-202G, Method 302, Test Condition A (After Opening) 10,000 ohms minimum.
Solderability	MIL-STD-202G, Method 208H
Resistance to solder Heat	MIL-STD-202G, Method 210F, Test Condition B (260+/-5°C,10+/-1 sec)
Thermal Shock	MIL-STD-202G, Method 107G, Test Condition B (-65°C to +125°C).
Operating Temperature	-55°C to +125°C
Terminal Strength	IEC-68-2-21

Electrical Specifications

Catalog Number	Ampere Rating	Typical Cold Resistance (ohms)	Volt-drop @100%In (Volt) max.	Voltage and Interrupting Ratings	Melting I ² T <10 mSec (A ² Sec)	Melting I ² T @10 In (A ² Sec)	Maximum Power Dissipation (W)	Agency Approvals		
										
3AG 500-R	500mA	1.19	3.17	See Table of Safety Approvals on Page 1 for Voltage and associated Interrupting Ratings	0.14	0.11	1.88	Y	Y	
3AG 750-R	750mA	0.66	2.54		0.19	0.17	2.15	Y	Y	
3AG 1-R	1A	0.155	0.28		1.4	1.4	0.37	Y	Y	Y
3AG 1.25-R	1.25A	0.114	0.27		2.4	2.5	0.44	Y	Y	Y
3AG 1.6-R	1.6A	0.085	0.27		4.2	4.4	0.51	Y	Y	Y
3AG 2-R	2A	0.057	0.22		7.2	7.6	0.59	Y	Y	Y
3AG 2.5-R	2.5A	0.043	0.21		12	13	0.70	Y	Y	Y
3AG 3-R	3A	0.033	0.17		21	23	0.83	Y	Y	Y
3AG 3.5-R	3.5A	0.027	0.18		28	31	0.91	Y	Y	Y
3AG 4-R	4A	0.024	0.17		36	40	1.00	Y	Y	Y
3AG 5-R	5A	0.018	0.16		63	70	1.20	Y	Y	Y
3AG 6-R	6A	0.014	0.15		107	123	1.40	Y	Y	Y
3AG 7-R	7A	0.012	0.16		141	162	1.60	Y	Y	Y
3AG 8-R	8A	0.010	0.15		184	214	1.70	Y	Y	Y
3AG 10-R	10A	0.008	0.13		316	372	2.00	Y	Y	Y
3AG 12-R	12A	0.006	0.13		501	597	2.40	Y	Y	Y
3AG 15-R	15A	0.006	0.15		845	1023	2.80	Y	Y	Y

Consult manufacturer for other ratings



Specifications subject to change without notice

Bel Fuse Inc.
206 Van Vorst Street
Jersey City, NJ 07302 USA

+1 201.432.0463
Bel.US.CS@belf.com
belfuse.com/circuit-protection

Temperature Derating Curve

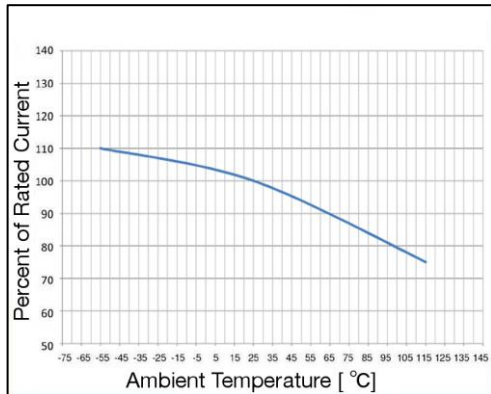

Average Time Current Curve

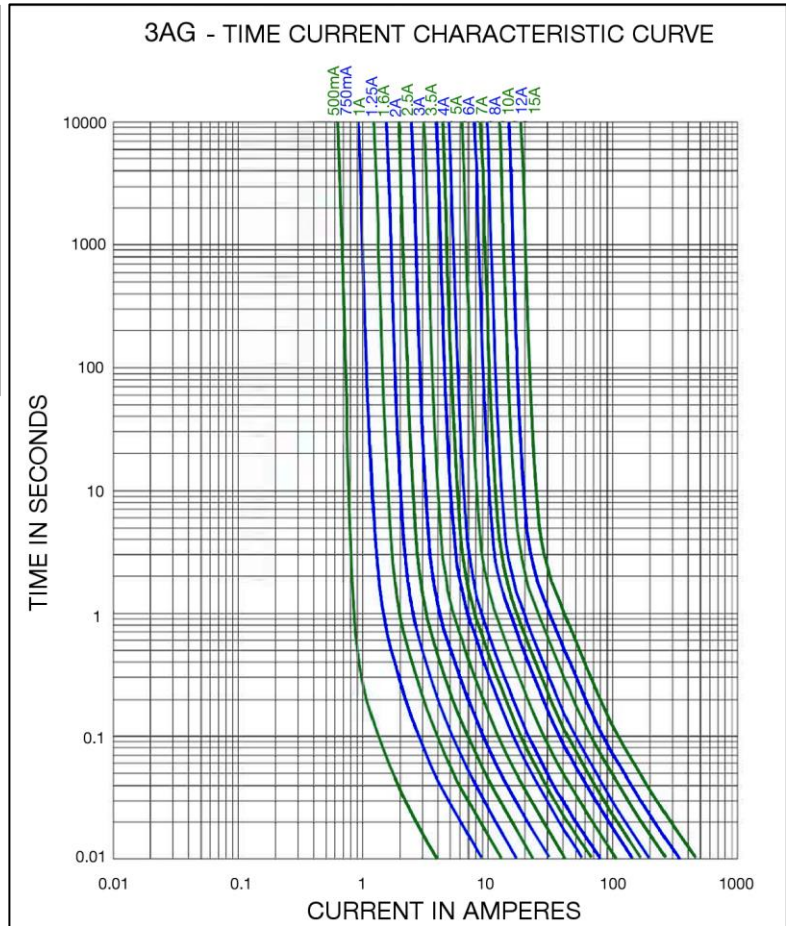

Soldering Parameters

Lead-free Wave Soldering Profile	
Wave Soldering Parameter	
Average ramp-up rate	200°C / second
Heating rate during preheat	typical 1 - 2°C / second Max 4°C / second
Final preheat temperature	within 125°C of soldering temperature
Peak temperature Tp	260°C
Time within +0°C / -5°C of actual peak temperature	10 seconds
Ramp-down rate	5°C / second max.

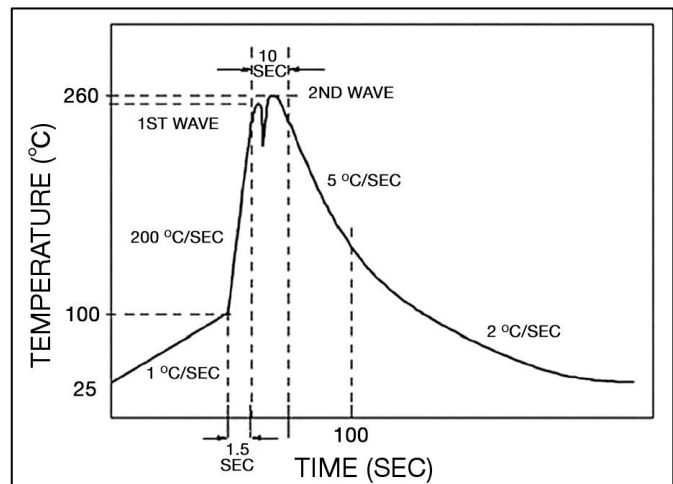

Fuse FGNO Explanation

06X1 R [XXXX] -XX

0601R=3AG; [XXXX]=Ampere Rating; XX=See Ordering Information as below

Fraction	Decimal	Milliamps	Bel FGNO[XXXX]
1/2	.500	500	0500
3/4	.750	750	0750

Fraction	Decimal	Amps	Bel FGNO[XXXX]
	1.0	1	1000
1-1/4	1.25	1.25	1250
	1.60	1.6	1600
	2.0	2	2000
2-1/2	2.5	2.5	2500
	3.0	3	3000
3-1/2	3.5	3.5	3500
	4.0	4	4000
	5.0	5	5000
	6.0	6	6000
	7.0	7	7000
	8.0	8	8000
		10	9100
		12	9120
		15	9150

Mechanical Dimensions

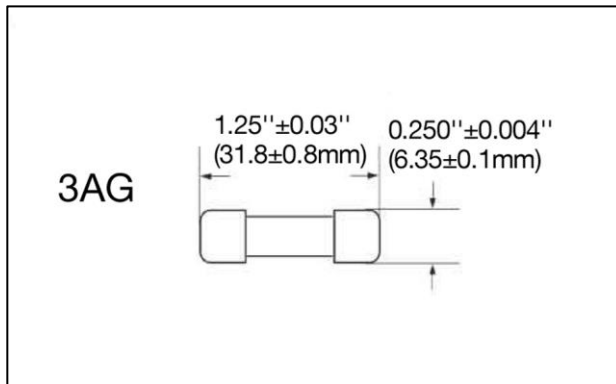

Ordering Information

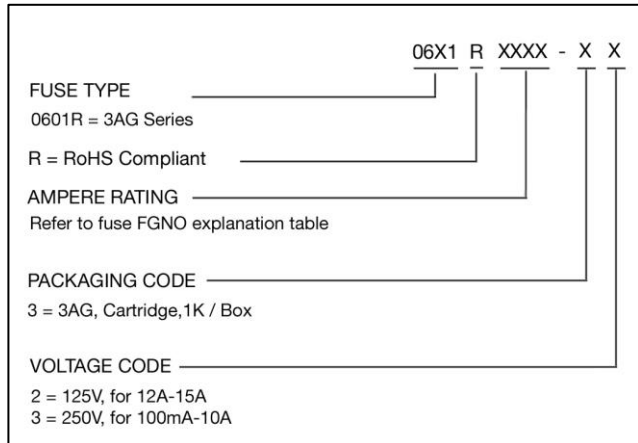

Packaging

Packaging Option	Packaging Specification	Quantity	Packaging Code	Inside Tape Spacing
Bulk	N/A	1000	33 / 32	N/A