

AC Filter, High Symmetrical Attenuation

new



Protection class II Case UL



Bolt and nut M4 Case PK



Wire leads Case PI

Description

- Line-filter in standard version
- 1-stage
- high attenuation
- 3 designs
 - N) excellent symmetrical noise attenuation
 - P) high symmetrical noise attenuation
 - Q) standard symmetrical noise attenuation

Unique Selling Proposition

- Excellent symmetrical attenuation
- Compact and cost optimized
- Completely closed steel housing
- Optional wire leads

Technical Data

Ratings IEC	1 - 60A @ Ta 40 °C / 250 VAC; 50Hz
Ratings UL/CSA	1 - 60A @ Ta 40 °C / 125/250VAC; 60Hz
Leakage Current	industrial < 1 mA (250V / 60Hz) standard < 0.5 mA (250 V / 60 Hz) medical (M5) < 5 µA (250 V / 60 Hz) medical (M80) < 80 µA (250 V / 60 Hz)
Dielectric Strength	> 1.7 kVDC between L-N > 2.7 kVDC between L/N-PE Protection class II: >5.6kVDC between L/N-metal housing Test voltage (2 sec)
Allowable Operation Temperature	-40 °C to 100 °C
Climatic Category	40/100/21 acc. to IEC 60068-1
Protection Class	Suitable for appliances with protection class I or II acc. to IEC 61140
Terminal	Quick connect terminal 6.3 x 0.8 mm Bolt and nut
Material	Nickel plated steel

See below:

Approvals and Compliances

Characteristics

- Compact filter with high symmetrical attenuation
- Designed for universal industrial applications
- Especially designed for applications with symmetrical noise caused by switching semiconductors
- Suitable for use in equipment according to IEC/UL 62368-1
- Suitable for use in medical equipment according to IEC/UL 60601-1 (1 MOOP, 1 MOPP), (Protection class II: 2 MOOP, 2 MOPP)

Other versions on request

- Version with wire connection
- Version with varistor for overvoltage protection

Weblinks

[pdf data sheet](#), [html datasheet](#), [General Product Information](#), [Approvals](#), [Distributor-Stock-Check](#), [Detailed request for product](#), [Microsite](#)

Surge protection	320 VAC 420 VDC 67 J
Line Filter	Standard, medical and industrial version, IEC 60939, UL 1283, CSA C22.2 no. 8 Technical Details
MTBF	> 200'000h acc. to MIL-HB-217 F

Approvals and Compliances



Detailed information on product approvals, code requirements, usage instructions and detailed test conditions can be looked up in [Details about Approvals](#)

SCHURTER products are designed for use in industrial environments. They have approvals from independent testing bodies according to national and international standards. Products with specific characteristics and requirements such as required in the automotive sector according to IATF 16949, medical technology according to ISO 13485 or in the aerospace industry can be offered exclusively with customer-specific, individual agreements by SCHURTER.

Approvals



The approval mark is used by the testing authorities to certify compliance with the safety requirements placed on electronic products.

Approval Reference Type: FMAB NEO

Approval Logo	Certificates	Certification Body	Description
	VDE Approvals	VDE	Certificate Number: 40041643
	UL Approvals	UL	UR File Number: E72928

Product standards

Product standards that are referenced

Organization	Design	Standard	Description
	Designed according to	IEC 60939	Passive filters for suppressing electromagnetic interference
	Designed according to	UL 1283	Electromagnetic interference filters
	Designed according to	CSA C22.2 no. 8	Electromagnetic interference (EMI) filters





Application standards

Application standards where the product can be used

Organization	Design	Standard	Description
	Suitable for applications acc.	IEC/UL 62368-1	Audio/video, information and communication technology equipment - Part 1: Safety requirements

Compliances

The product complies with following Guide Lines

Identification	Details	Initiator	Description
	CE declaration of conformity	SCHURTER AG	The CE marking declares that the product complies with the applicable requirements laid down in the harmonisation of Community legislation on its affixing in accordance with EU Regulation 765/2008.
	UKCA declaration of conformity	SCHURTER AG	The UKCA marking declares that the product complies with the applicable requirements laid down in the British Amendment of Regulation (EC) 765/2008.
	RoHS	SCHURTER AG	Directive RoHS 2011/65/EU, Amendment (EU) 2015/863
	China RoHS	SCHURTER AG	The law SJ / T 11363-2006 (China RoHS) has been in force since 1 March 2007. It is similar to the EU directive RoHS.
	REACH	SCHURTER AG	On 1 June 2007, Regulation (EC) No 1907/2006 on the Registration, Evaluation, Authorization and Restriction of Chemicals 1 (abbreviated as "REACH") entered into force.

Dimension [mm]

Case PG with quick connect terminals

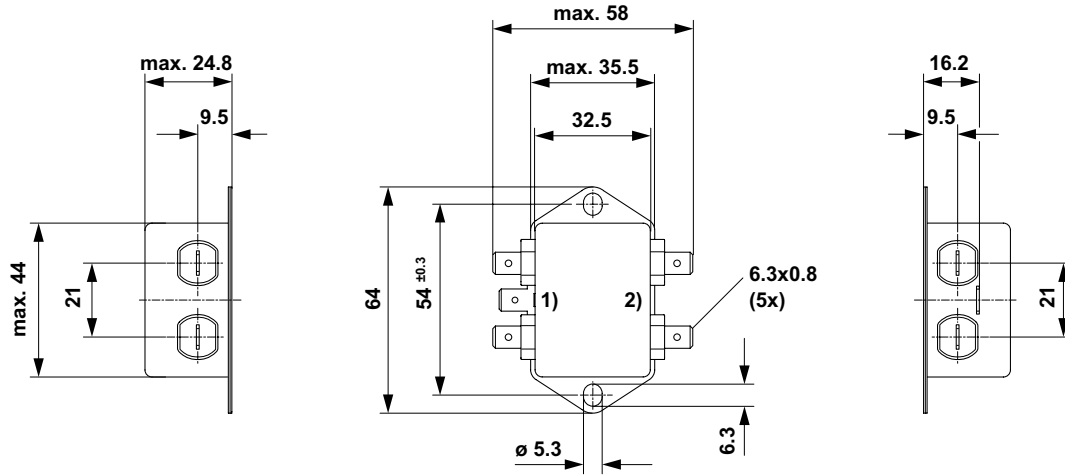

- 1) Line
- 2) Load

Case PH with quick connect terminals

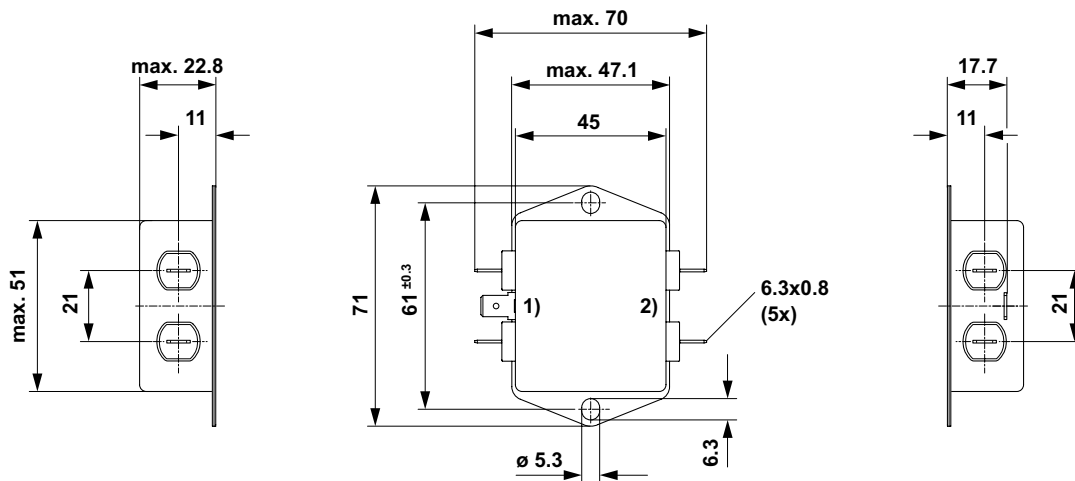

- 1) Line
- 2) Load

Case PI with quick connect terminals

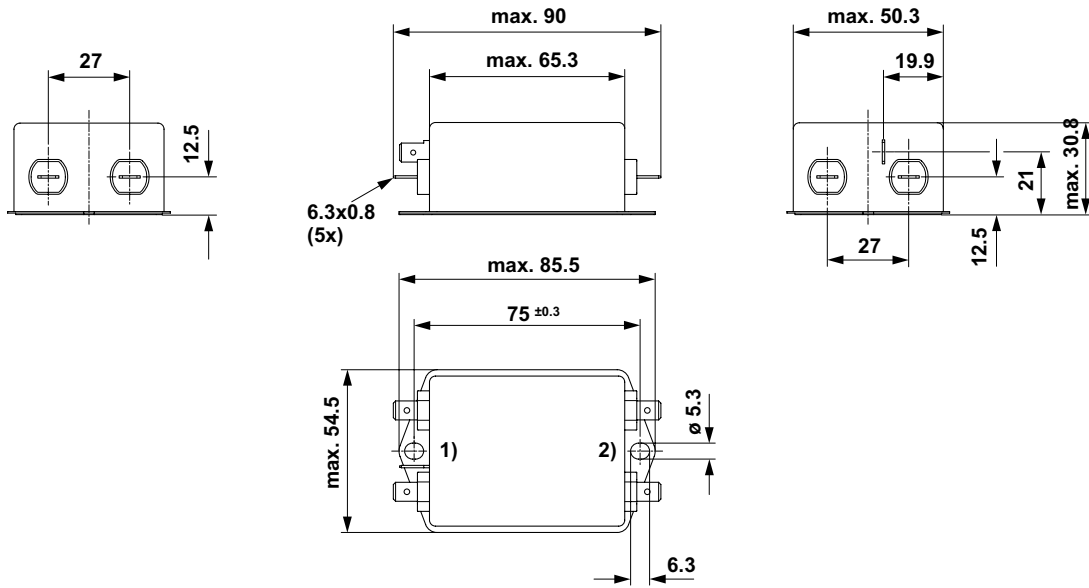

- 1) Line
- 2) Load

Case PK with quick connect terminals

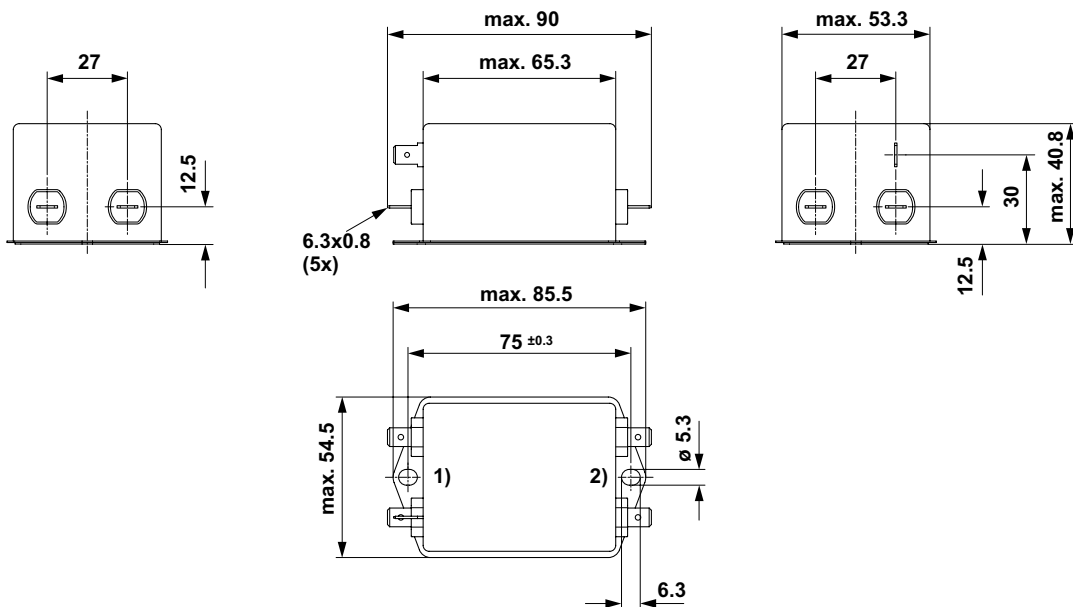

- 1) Line
- 2) Load

Case PK with bolt and nut

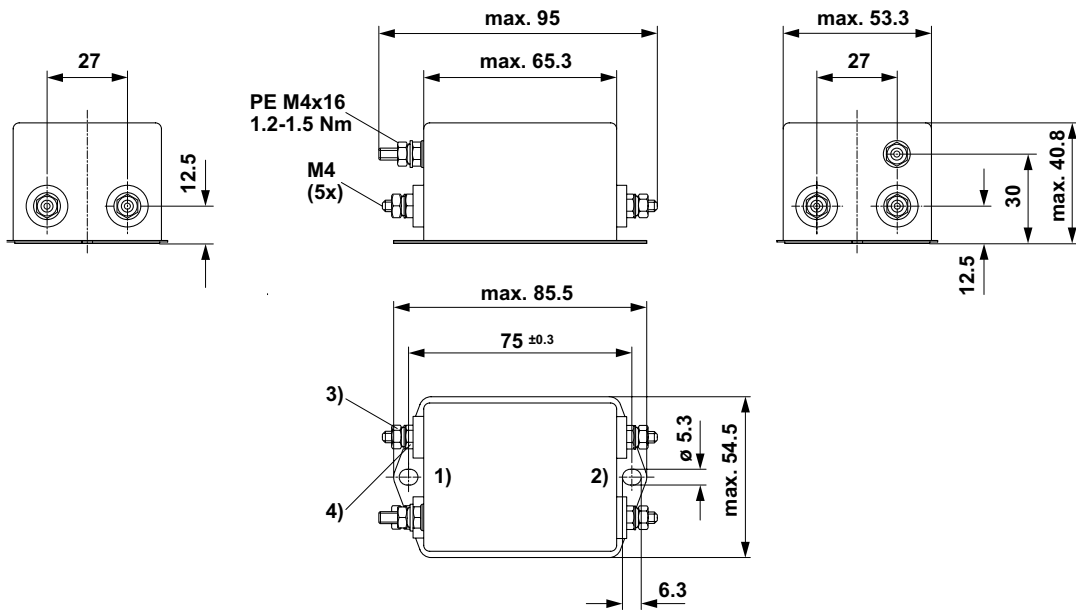

- 1) Line
- 2) Load
- 3) Nut torque 0.8..1 Nm, keep lock-nut fastened
- 4) Lock-nut do not unscrew

Case QC with quick connect terminals

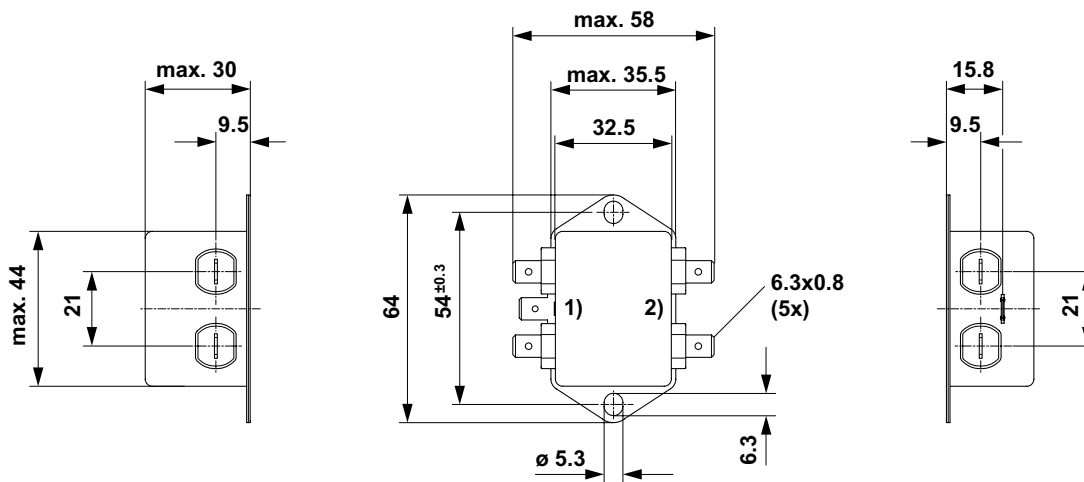

- 1) Line
- 2) Load

Case QD with quick connect terminals

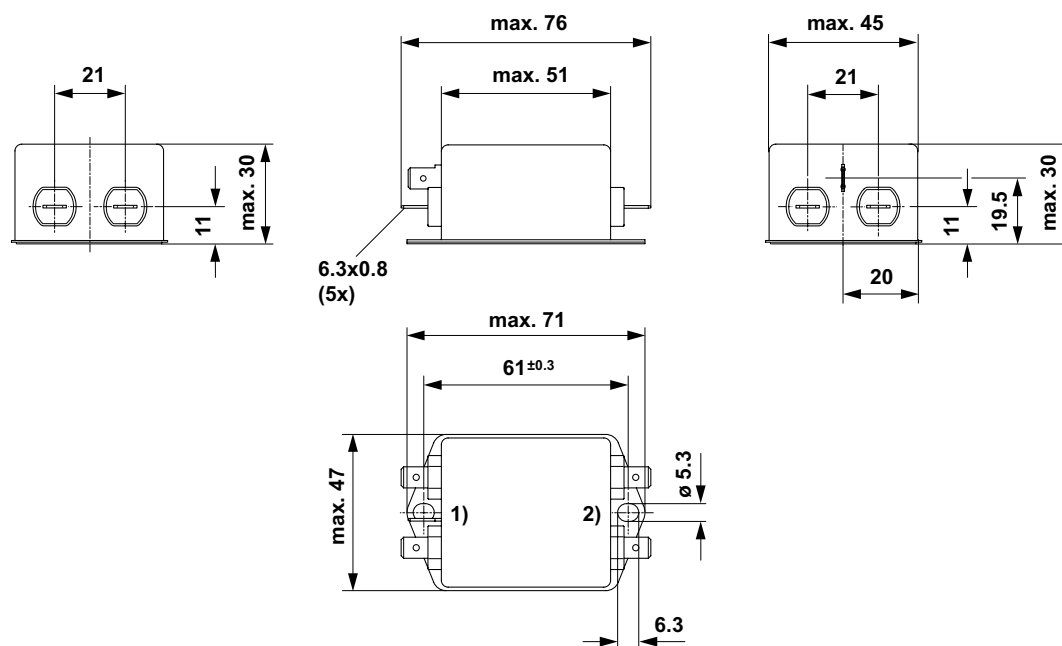

- 1) Line
- 2) Load

Case QE with bolt and nut

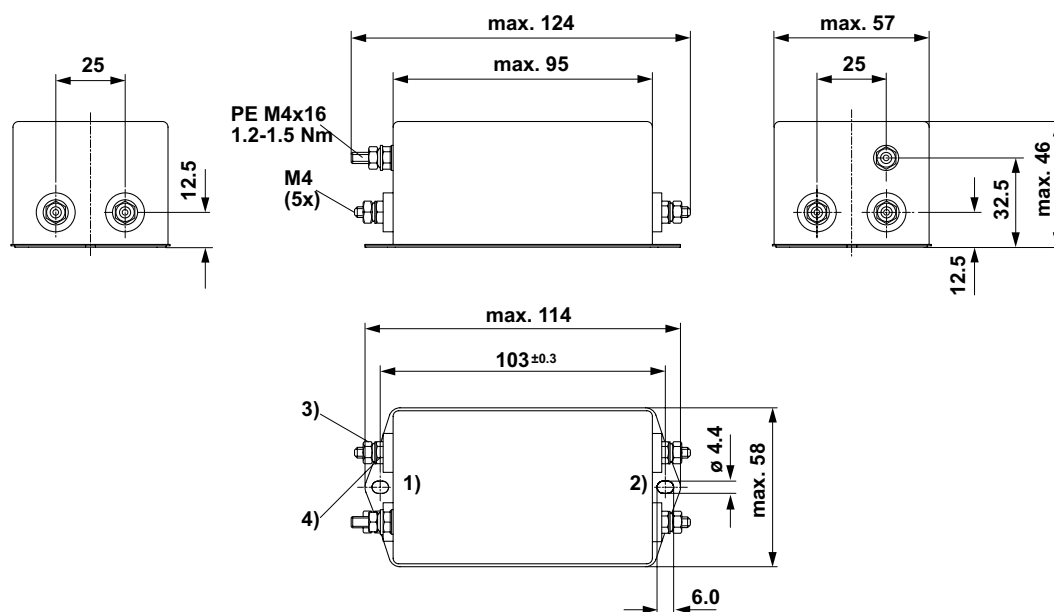

- 1) Line
- 2) Load
- 3) Nut torque 0.8...1 Nm, keep lock-nut fastened
- 4) Lock-nut do not unscrew

Case QF with bolt and nut

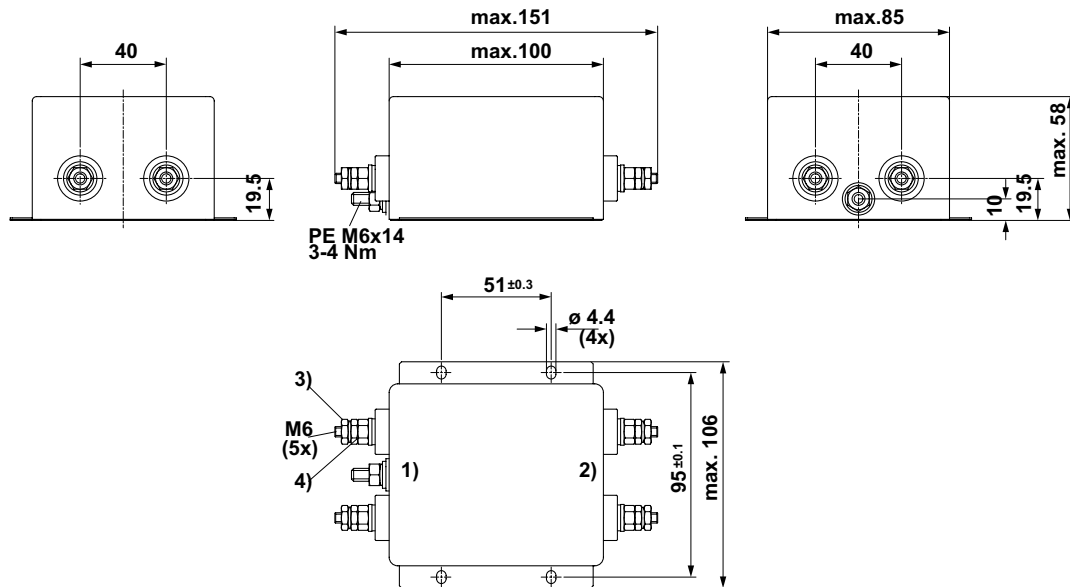

- 1) Line
- 2) Load
- 3) Nut torque 0.8...1 Nm, keep lock-nut fastened
- 4) Lock-nut do not unscrew

Case with wire leads

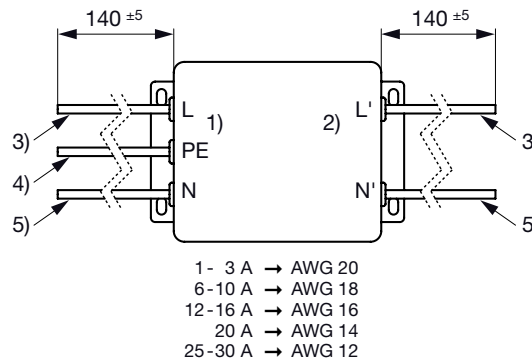

- 1) Line
- 2) Load
- 3) Brown
- 4) Yellow-Green
- 5) Blue

Case UL Protection class II

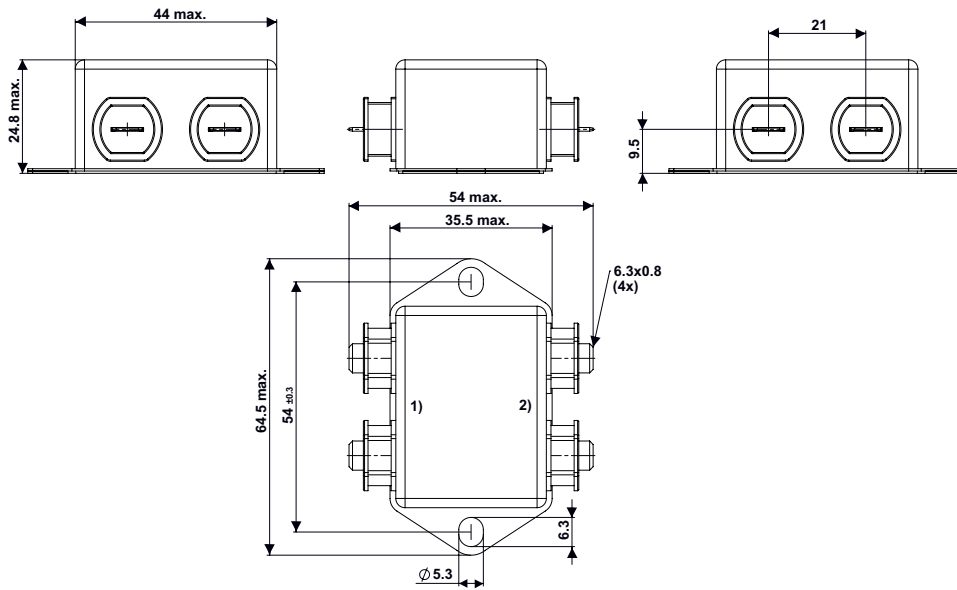

- 1) Line
- 2) Load

Case UM Protection class II

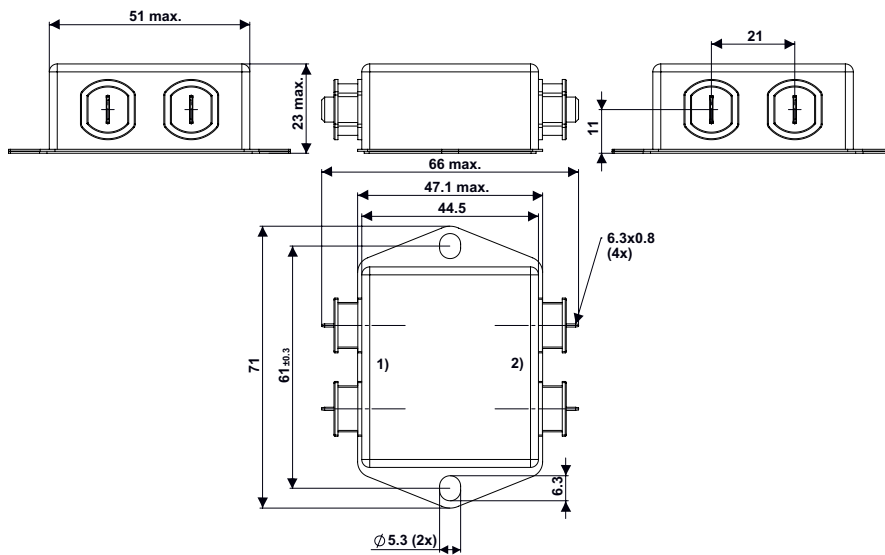

- 1) Line
- 2) Load

Case UN Protection class II

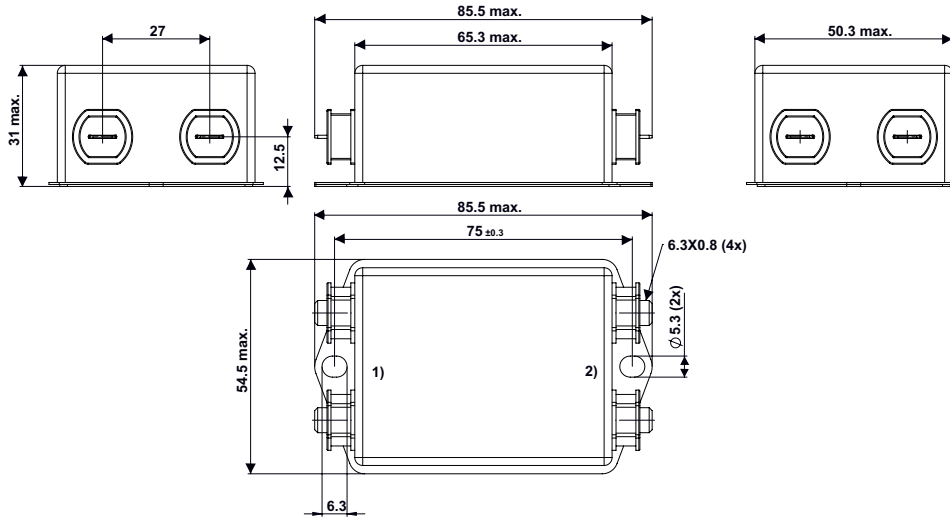

- 1) Line
- 2) Load

Case UO Protection class II

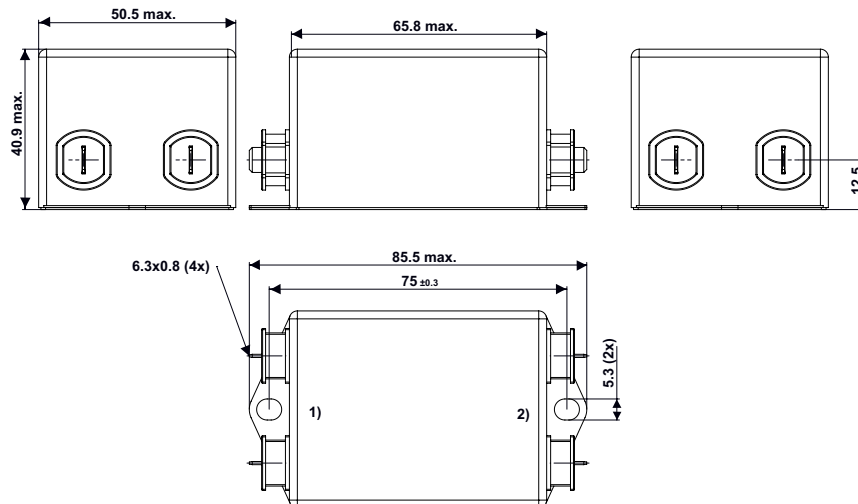

- 1) Line
- 2) Load

Diagrams

Standard Version or medical M80
 Design N, P

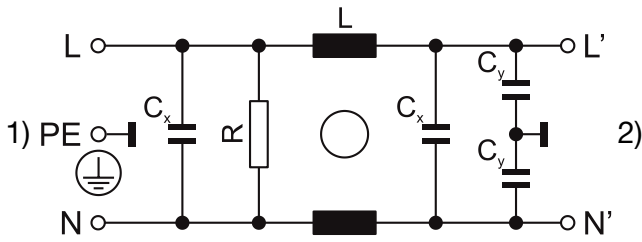

1) Line
 2) Load

Medical Version (M5)
 Design N, P

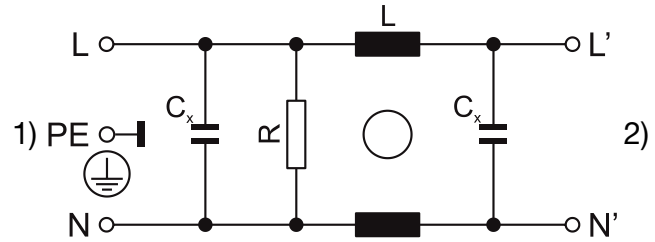

1) Line
 2) Load

Standard Version or medical M80
 Design Q

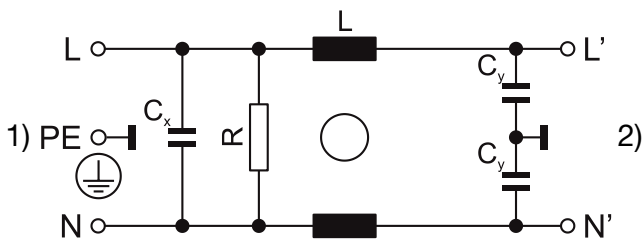

1) Line
 2) Load

Medical Version (M5)
 Design Q

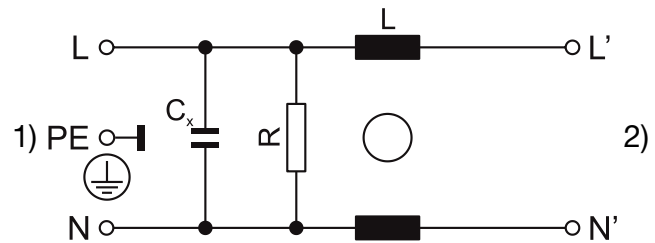

1) Line
 2) Load

Medical Version (M5)
 Protection class II

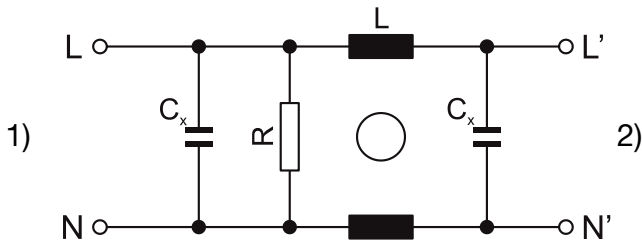

1) Line
 2) Load

Attenuation Loss . . . 0.1/100Ω differential mode 100/0.1Ω differential mode - - - - 50Ω differential mode ____ 50Ω common mode
 Standard version

1 A / Design N

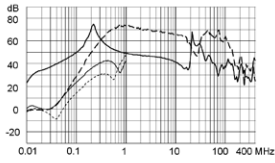

3 A / Design N

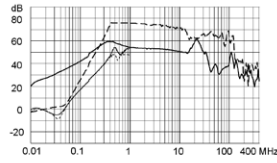

4 A / Design N

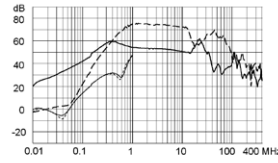

6 A / Design N

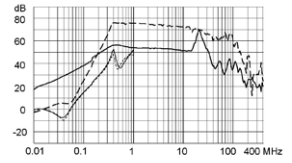

8 A / Design N

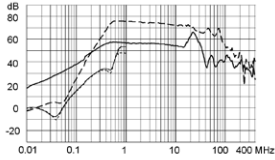

10 A / Design N

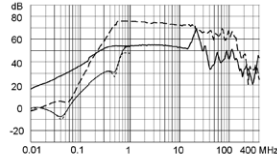

12 A / Design N

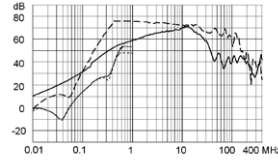

16 A / Design N

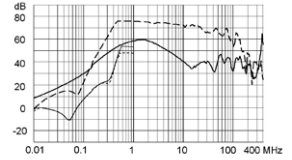

20 A / Design N

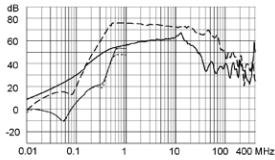

30 A / Design N

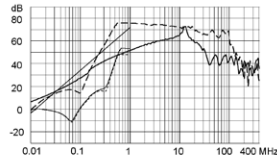

1 A / Design P

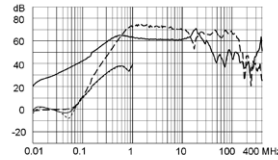

3 A / Design P

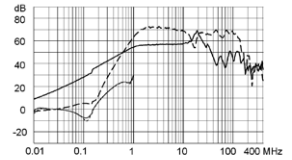

6 A / Design P

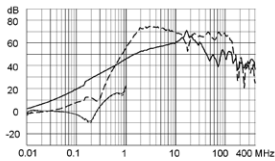

10 A / Design P

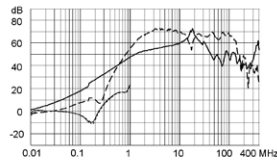

12 A / Design P

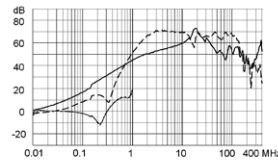

16 A / Design P

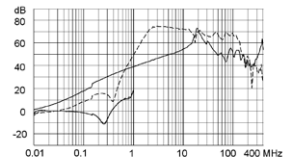

20 A / Design P

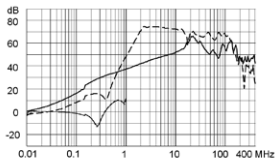

30 A / Design P

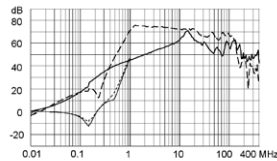

60 A / Design P

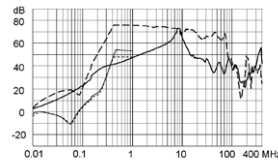

1 A / Design Q

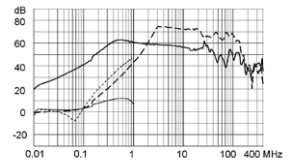

3 A / Design Q

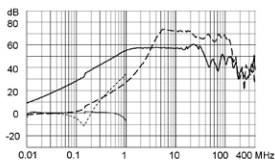

6 A / Design Q

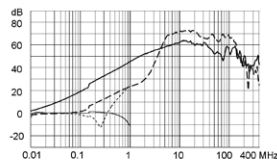

10 A / Design Q

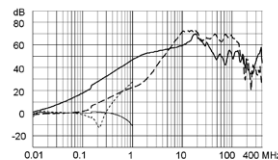

12 A / Design Q

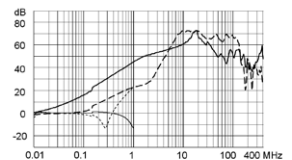

16 A / Design Q

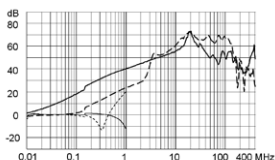

20 A / Design Q

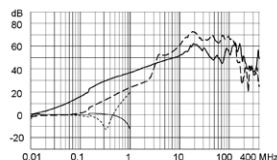

30 A / Design Q

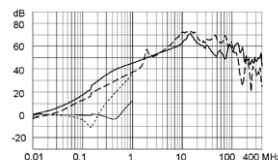

60 A / Design Q

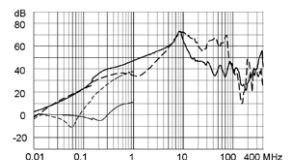

Medical version (M5)

1 A / Design N

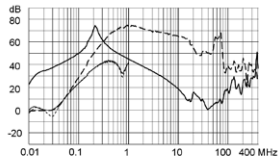

3 A / Design N

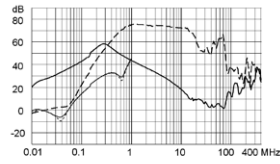

4 A / Design N

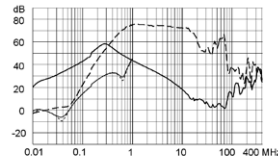

6 A / Design N

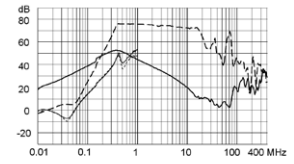

8 A / Design N

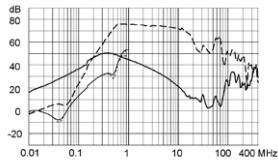

10 A / Design N

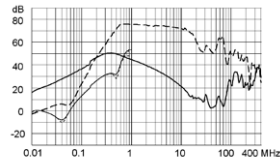

12 A / Design N

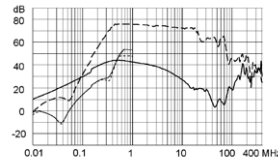

16 A / Design N

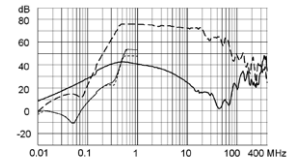

20 A / Design N

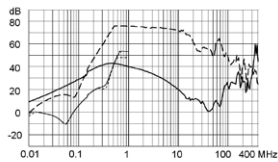

30 A / Design N

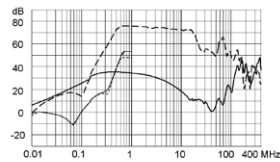

1 A / Design P

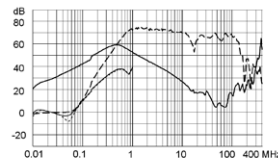

3 A / Design P

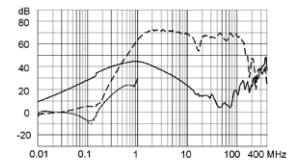

6 A / Design P

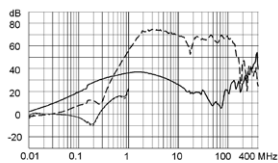

10 A / Design P

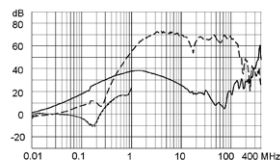

12 A / Design P

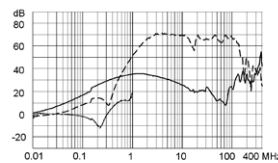

16 A / Design P

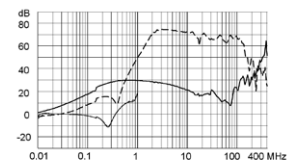

20 A / Design P

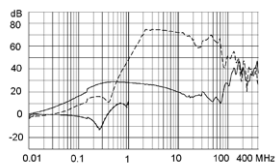

30 A / Design P

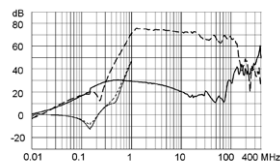

60 A / Design P

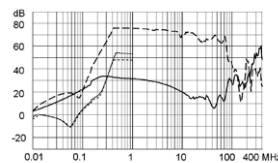

1 A / Design Q

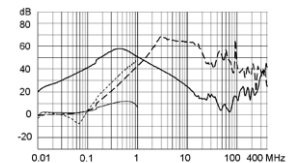

3 A / Design Q

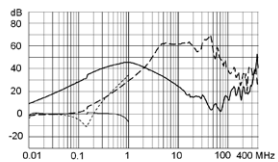

6 A / Design Q

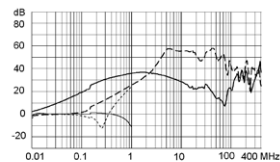

10 A / Design Q

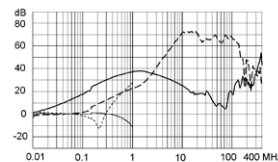

12 A / Design Q

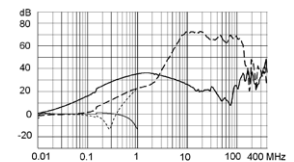

16 A / Design Q

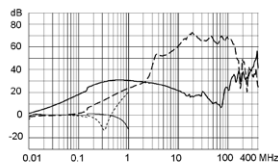

20 A / Design Q

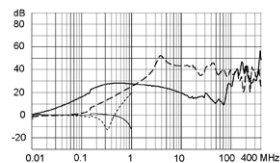

30 A / Design Q

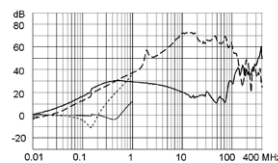

60 A / Design Q

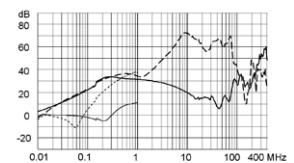

Medical version (M80)

1 A / Design N

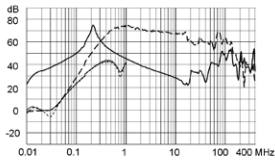

3 A / Design N

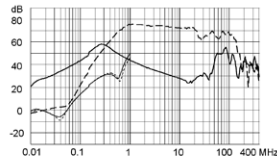

4 A / Design N

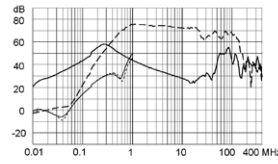

6 A / Design N

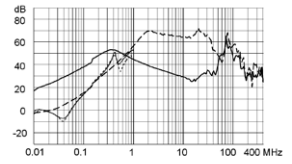

8 A / Design N

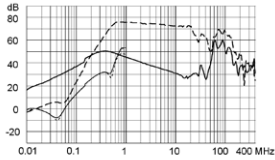

10 A / Design N

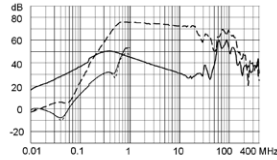

12 A / Design N

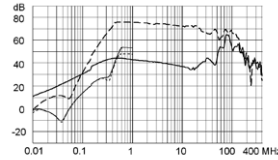

16 A / Design N

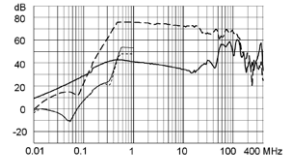

20 A / Design N

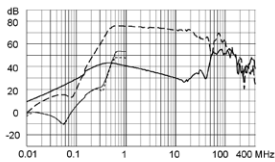

30 A / Design N

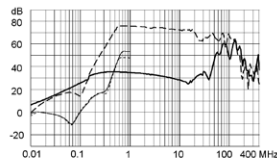

1 A / Design P

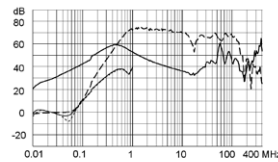

3 A / Design P

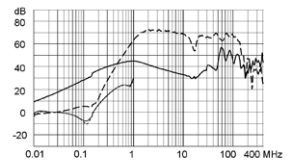

6 A / Design P

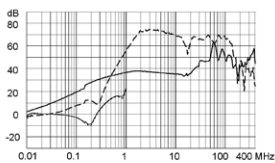

10 A / Design P

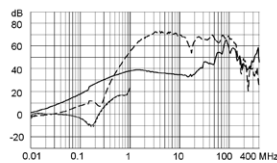

12 A / Design P

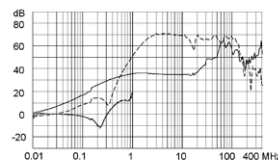

16 A / Design P

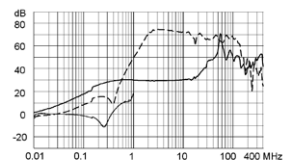

20 A / Design P

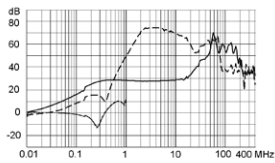

30 A / Design P

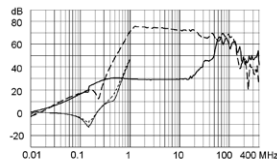

60 A / Design P

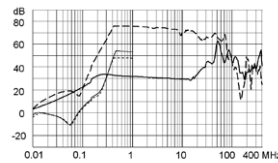

1 A / Design Q

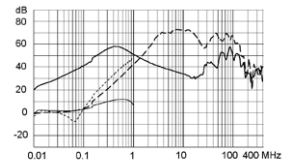

3 A / Design Q

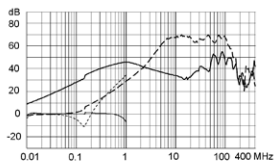

6 A / Design Q

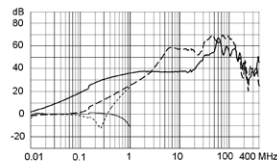

10 A / Design Q

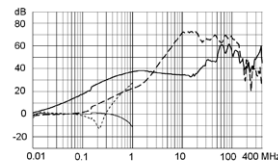

12 A / Design Q

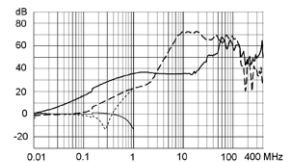

16 A / Design Q

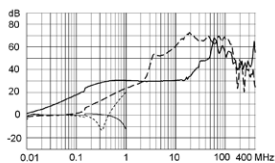

20 A / Design Q

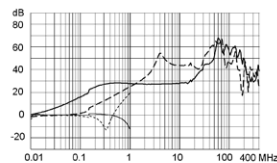

30 A / Design Q

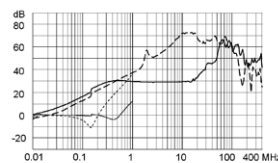

60 A / Design Q

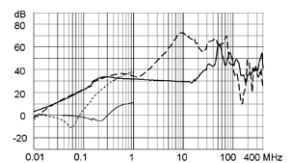

Medical (M5) HP

1 A / Protection class II

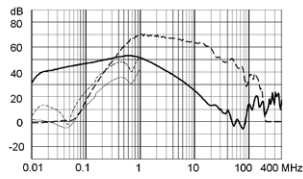

3 A / Protection class II

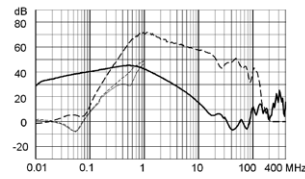

4 A / Protection class II

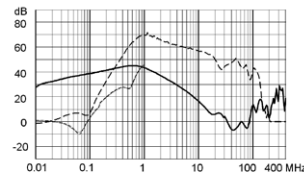

6 A / Protection class II

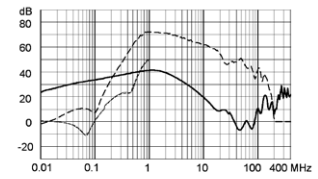

8 A / Protection class II

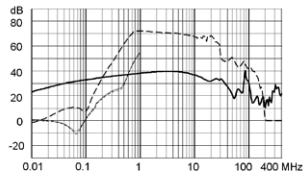

10 A / Protection class II

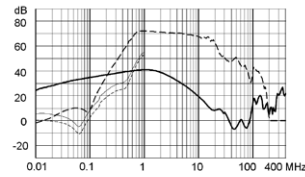

12 A / Protection class II

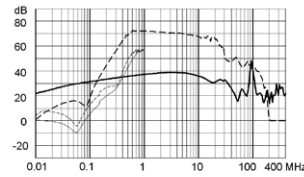

16 A / Protection class II

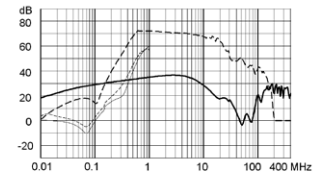

20 A / Protection class II

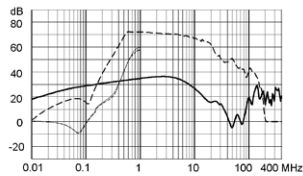

All Variants

Rated current	Filter-Type	Terminal	Design	Pro-tection Class	Leakage Current	Ri	Power Loss	Surge pro-tection	Weight	Housing	Packa-ging	Order Number
[A]					[mA]	[mΩ]	[W]		[g]		[ST]	
1	Standard version	QC 6.3 x 0.8 mm	N	I	0.5	475	1	-	72g	PG	15	5500.2630.01
1	Standard version	QC 6.3 x 0.8 mm	N	I	0.5	475	1	VDR	72g	PG	15	5500.2630.21
1	Standard version	QC 6.3 x 0.8 mm	P	I	0.5	320	0.65	-	80g	QC	15	5500.2640.01
1	Standard version	QC 6.3 x 0.8 mm	Q	I	0.5	320	0.65	-	66g	PG	15	5500.2650.01
3	Standard version	QC 6.3 x 0.8 mm	N	I	0.5	83	1.5	-	104g	PH	15	5500.2631.01
3	Standard version	QC 6.3 x 0.8 mm	N	I	0.5	83	1.5	VDR	104g	PH	15	5500.2631.21
3	Standard version	QC 6.3 x 0.8 mm	P	I	0.5	36	0.65	-	81g	QC	15	5500.2641.01
3	Standard version	QC 6.3 x 0.8 mm	Q	I	0.5	36	0.65	-	70g	PG	15	5500.2651.01
4	Standard version	QC 6.3 x 0.8 mm	N	I	0.5	53	1.7	-	108g	PH	15	5500.2632.01
4	Standard version	QC 6.3 x 0.8 mm	N	I	0.5	53	1.7	VDR	108g	PH	15	5500.2632.21
6	Standard version	QC 6.3 x 0.8 mm	N	I	0.5	32.5	2.4	-	109g	PH	15	5500.2633.01
6	Standard version	QC 6.3 x 0.8 mm	N	I	0.5	32.5	2.4	VDR	109g	PH	15	5500.2633.21
6	Standard version	QC 6.3 x 0.8 mm	P	I	0.5	12	0.86	-	80g	QC	15	5500.2642.01
6	Standard version	QC 6.3 x 0.8 mm	Q	I	0.5	12	0.86	-	100g	PG	15	5500.2652.01
8	Standard version	QC 6.3 x 0.8 mm	N	I	0.5	29.2	3.8	-	190g	PI	10	5500.2634.01
8	Standard version	QC 6.3 x 0.8 mm	N	I	0.5	29.2	3.8	VDR	190g	PI	10	5500.2634.21
10	Standard version	QC 6.3 x 0.8 mm	P	I	0.5	5	1	-	87g	QC	15	5500.2643.01
10	Standard version	QC 6.3 x 0.8 mm	Q	I	0.5	5	1	-	90g	QC	15	5500.2653.01
12	Standard version	QC 6.3 x 0.8 mm	P	I	0.5	4	1.2	-	92g	QC	15	5500.2644.01
12	Standard version	QC 6.3 x 0.8 mm	Q	I	0.5	4	1.2	-	90g	QC	15	5500.2654.01
16	Standard version	QC 6.3 x 0.8 mm	P	I	0.5	2	1	-	138g	QD	15	5500.2645.01
16	Standard version	QC 6.3 x 0.8 mm	Q	I	0.5	2	1	-	136g	QD	15	5500.2655.01
20	Standard version	QC 6.3 x 0.8 mm	P	I	0.5	1.9	1.5	-	206g	PI	10	5500.2646.01
20	Standard version	QC 6.3 x 0.8 mm	Q	I	0.5	1.9	1.5	-	204g	PI	10	5500.2656.01

Rated current	Filter-Type	Terminal	Design	Pro-tection Class	Leakage Current	Ri	Power Loss	Surge pro-tection	Weight	Housing	Packa-ging	Order Number
[A]					[mA]	[mΩ]	[W]		[g]		[ST]	
10	Industrial version	QC 6.3 x 0.8 mm	N	I	1	22.8	4.6	-	200g	PI	10	5500.2635.01
10	Industrial version	QC 6.3 x 0.8 mm	N	I	1	22.8	4.6	VDR	200g	PI	10	5500.2635.21
12	Industrial version	QC 6.3 x 0.8 mm	N	I	1	13.2	3.8	-	201g	PI	10	5500.2636.01
12	Industrial version	QC 6.3 x 0.8 mm	N	I	1	13.2	3.8	VDR	201g	PI	10	5500.2636.21
16	Industrial version	QC 6.3 x 0.8 mm	N	I	1	7.2	3.7	-	308g	PK	10	5500.2637.01
16	Industrial version	QC 6.3 x 0.8 mm	N	I	1	7.2	3.7	VDR	308g	PK	10	5500.2637.21
20	Industrial version	QC 6.3 x 0.8 mm	N	I	1	6.0	4.8	-	322g	PK	10	5500.2638.01
20	Industrial version	QC 6.3 x 0.8 mm	N	I	1	6.0	4.8	VDR	322g	PK	10	5500.2638.21
30	Industrial version	Bolt and nut M4	N	I	1	2.9	5.2	-	355g	PK	10	5500.2639.03
30	Industrial version	Bolt and nut M4	P	I	1	1	1.8	-	450g	QE	5	5500.2647.03
30	Industrial version	Bolt and nut M4	Q	I	1	1	1.8	-	450g	QE	5	5500.2657.03
60	Industrial version	Bolt and nut M6	P	I	1	1	7.2	-	1220g	QF	1	5500.2648.03
60	Industrial version	Bolt and nut M6	Q	I	1	1	7.2	-	1220g	QF	1	5500.2658.03
1	Medical (M5)	QC 6.3 x 0.8 mm	N	II	0.005	540	1.08	-	72g	UL	15	3-134-821
1	Medical (M5)	QC 6.3 x 0.8 mm	N	I	0.005	475	1	-	72g	PG	15	5500.2630.04
1	Medical (M5)	QC 6.3 x 0.8 mm	P	I	0.005	320	0.65	-	80g	QC	15	5500.2640.04
1	Medical (M5)	QC 6.3 x 0.8 mm	Q	I	0.005	320	0.65	-	66g	PG	15	5500.2650.04
3	Medical (M5)	QC 6.3 x 0.8 mm	N	II	0.005	82	1.48	-	104g	UM	15	3-134-822
3	Medical (M5)	QC 6.3 x 0.8 mm	N	I	0.005	83	1.5	-	104g	PH	15	5500.2631.04
3	Medical (M5)	QC 6.3 x 0.8 mm	P	I	0.005	36	0.65	-	81g	QC	15	5500.2641.04
3	Medical (M5)	QC 6.3 x 0.8 mm	Q	I	0.005	36	0.65	-	70g	PG	15	5500.2651.04
4	Medical (M5)	QC 6.3 x 0.8 mm	N	II	0.005	50	1.6	-	108g	UM	15	3-134-823
4	Medical (M5)	QC 6.3 x 0.8 mm	N	I	0.005	53	1.7	-	108g	PH	15	5500.2632.04
6	Medical (M5)	QC 6.3 x 0.8 mm	N	II	0.005	32	2.3	-	110g	UM	15	3-134-824
6	Medical (M5)	QC 6.3 x 0.8 mm	N	I	0.005	32.5	2.4	-	109g	PH	15	5500.2633.04
6	Medical (M5)	QC 6.3 x 0.8 mm	P	I	0.005	12	0.86	-	80g	QC	15	5500.2642.04
6	Medical (M5)	QC 6.3 x 0.8 mm	Q	I	0.005	12	0.86	-	100g	PG	15	5500.2652.04
8	Medical (M5)	QC 6.3 x 0.8 mm	N	II	0.005	29	3.71	-	188g	UN	10	3-134-825
8	Medical (M5)	QC 6.3 x 0.8 mm	N	I	0.005	29.2	3.8	-	190g	PI	10	5500.2634.04
10	Medical (M5)	QC 6.3 x 0.8 mm	N	II	0.005	19	3.8	-	200g	UN	10	3-134-826
10	Medical (M5)	QC 6.3 x 0.8 mm	N	I	0.005	22.8	4.6	-	200g	PI	10	5500.2635.04
10	Medical (M5)	QC 6.3 x 0.8 mm	P	I	0.005	5	1	-	87g	QC	15	5500.2643.04
10	Medical (M5)	QC 6.3 x 0.8 mm	Q	I	0.005	5	1	-	90g	QC	15	5500.2653.04
12	Medical (M5)	QC 6.3 x 0.8 mm	N	II	0.005	11	3.17	-	200g	UN	10	3-134-827
12	Medical (M5)	QC 6.3 x 0.8 mm	N	I	0.005	13.2	3.8	-	201g	PI	10	5500.2636.04
12	Medical (M5)	QC 6.3 x 0.8 mm	P	I	0.005	4	1.2	-	92g	QC	15	5500.2644.04
12	Medical (M5)	QC 6.3 x 0.8 mm	Q	I	0.005	4	1.2	-	90g	QC	15	5500.2654.04
16	Medical (M5)	QC 6.3 x 0.8 mm	N	II	0.005	6	3.07	-	310g	UO	10	3-134-828
16	Medical (M5)	QC 6.3 x 0.8 mm	N	I	0.005	7.2	3.7	-	308g	PK	10	5500.2637.04
16	Medical (M5)	QC 6.3 x 0.8 mm	P	I	0.005	2	1	-	138g	QD	15	5500.2645.04
16	Medical (M5)	QC 6.3 x 0.8 mm	Q	I	0.005	2	1	-	136g	QD	15	5500.2655.04
20	Medical (M5)	QC 6.3 x 0.8 mm	N	II	0.005	5	4	-	322g	UO	10	3-134-829
20	Medical (M5)	QC 6.3 x 0.8 mm	N	I	0.005	6	4.8	-	322g	PK	10	5500.2638.04
20	Medical (M5)	QC 6.3 x 0.8 mm	P	I	0.005	1.9	1.5	-	206g	PI	10	5500.2646.04
20	Medical (M5)	QC 6.3 x 0.8 mm	Q	I	0.005	1.9	1.5	-	204g	PI	10	5500.2656.04
30	Medical (M5)	Bolt and nut M4	N	I	0.005	2.9	5.2	-	355g	PK	10	5500.2639.06
30	Medical (M5)	Bolt and nut M4	P	I	0.005	1	1.8	-	450g	QE	5	5500.2647.06

Rated current	Filter-Type	Terminal	Design	Pro-tection Class	Leakage Current	Ri	Power Loss	Surge pro-tection	Weight	Housing	Packa-ging	Order Number
[A]					[mA]	[mΩ]	[W]		[g]		[ST]	
30	Medical (M5)	Bolt and nut M4	Q	I	0.005	1	1.8	-	450 g	QE	5	5500.2657.06
60	Medical (M5)	Bolt and nut M6	P	I	0.005	1	7.2	-	1220 g	QF	1	5500.2648.06
60	Medical (M5)	Bolt and nut M6	Q	I	0.005	1	7.2	-	1220 g	QF	1	5500.2658.06
1	Medical (M80)	QC 6.3 x 0.8 mm	N	I	0.08	475	1	-	72 g	PG	15	5500.2630.07
1	Medical (M80)	QC 6.3 x 0.8 mm	P	I	0.08	320	0.65	-	80 g	QC	15	5500.2640.07
1	Medical (M80)	QC 6.3 x 0.8 mm	Q	I	0.08	320	0.65	-	66 g	PG	15	5500.2650.07
3	Medical (M80)	QC 6.3 x 0.8 mm	N	I	0.08	83	1.5	-	104 g	PH	15	5500.2631.07
3	Medical (M80)	QC 6.3 x 0.8 mm	P	I	0.08	36	0.65	-	81 g	QC	15	5500.2641.07
3	Medical (M80)	QC 6.3 x 0.8 mm	Q	I	0.08	36	0.65	-	70 g	PG	15	5500.2651.07
4	Medical (M80)	QC 6.3 x 0.8 mm	N	I	0.08	53	1.7	-	108 g	PH	15	5500.2632.07
6	Medical (M80)	QC 6.3 x 0.8 mm	N	I	0.08	32.5	2.4	-	109 g	PH	15	5500.2633.07
6	Medical (M80)	QC 6.3 x 0.8 mm	P	I	0.08	12	0.86	-	80 g	QC	15	5500.2642.07
6	Medical (M80)	QC 6.3 x 0.8 mm	Q	I	0.08	12	0.86	-	100 g	PG	15	5500.2652.07
8	Medical (M80)	QC 6.3 x 0.8 mm	N	I	0.08	29.2	3.8	-	190 g	PI	10	5500.2634.07
10	Medical (M80)	QC 6.3 x 0.8 mm	N	I	0.08	22.8	4.6	-	200 g	PI	10	5500.2635.07
10	Medical (M80)	QC 6.3 x 0.8 mm	P	I	0.08	5	1	-	87 g	QC	15	5500.2643.07
10	Medical (M80)	QC 6.3 x 0.8 mm	Q	I	0.08	5	1	-	90 g	QC	15	5500.2653.07
12	Medical (M80)	QC 6.3 x 0.8 mm	N	I	0.08	13.2	3.8	-	201 g	PI	10	5500.2636.07
12	Medical (M80)	QC 6.3 x 0.8 mm	P	I	0.08	4	1.2	-	92 g	QC	15	5500.2644.07
12	Medical (M80)	QC 6.3 x 0.8 mm	Q	I	0.08	4	1.2	-	90 g	QC	15	5500.2654.07
16	Medical (M80)	QC 6.3 x 0.8 mm	N	I	0.08	7.2	3.7	-	308 g	PK	10	5500.2637.07
16	Medical (M80)	QC 6.3 x 0.8 mm	P	I	0.08	2	1	-	138 g	QD	15	5500.2645.07
16	Medical (M80)	QC 6.3 x 0.8 mm	Q	I	0.08	2	1	-	136 g	QD	15	5500.2655.07
20	Medical (M80)	QC 6.3 x 0.8 mm	N	I	0.08	6.0	4.8	-	322 g	PK	10	5500.2638.07
20	Medical (M80)	QC 6.3 x 0.8 mm	P	I	0.08	1.9	1.5	-	206 g	PI	10	5500.2646.07
20	Medical (M80)	QC 6.3 x 0.8 mm	Q	I	0.08	1.9	1.5	-	204 g	PI	10	5500.2656.07
30	Medical (M80)	Bolt and nut M4	N	I	0.08	2.9	5.2	-	355 g	PK	10	5500.2639.09
30	Medical (M80)	Bolt and nut M4	P	I	0.08	1	1.8	-	450 g	QE	5	5500.2647.09
30	Medical (M80)	Bolt and nut M4	Q	I	0.08	1	1.8	-	450 g	QE	5	5500.2657.09
60	Medical (M80)	Bolt and nut M6	P	I	0.08	1	7.2	-	1220 g	QF	1	5500.2648.09
60	Medical (M80)	Bolt and nut M6	Q	I	0.08	1	7.2	-	1220 g	QF	1	5500.2658.09
1	Medical (M5) HP	QC 6.3 x 0.8 mm	N	II	0.005	280	0.56	-	72 g	UL	15	3-134-830
3	Medical (M5) HP	QC 6.3 x 0.8 mm	N	II	0.005	50	0.9	-	104 g	UM	15	3-134-831
4	Medical (M5) HP	QC 6.3 x 0.8 mm	N	II	0.005	30	0.96	-	108 g	UM	15	3-134-832
6	Medical (M5) HP	QC 6.3 x 0.8 mm	N	II	0.005	16.4	1.18	-	110 g	UM	15	3-134-833
8	Medical (M5) HP	QC 6.3 x 0.8 mm	N	II	0.005	18.5	2.37	-	188 g	UN	10	3-134-834
10	Medical (M5) HP	QC 6.3 x 0.8 mm	N	II	0.005	12.5	2.5	-	200 g	UN	10	3-134-835
12	Medical (M5) HP	QC 6.3 x 0.8 mm	N	II	0.005	7.9	2.28	-	200 g	UN	10	3-134-836
16	Medical (M5) HP	QC 6.3 x 0.8 mm	N	II	0.005	4.2	2.15	-	310 g	UO	10	3-134-837
20	Medical (M5) HP	QC 6.3 x 0.8 mm	N	II	0.005	3.4	2.72	-	322 g	UO	10	3-134-838

Most Popular.

Availability for all products can be searched real-time: <https://www.schurter.com/en/Stock-Check/Stock-Check-SCHURTER>

3 designs N) excellent symmetrical noise attenuation
 P) high symmetrical noise attenuation
 Q) standard symmetrical noise attenuation

Rated current	Filter-Type	Terminal	Design	Pro-tection Class	Leakage Current	Ri	Power Loss	Surge pro-tection	Weight	Housing	Packa-ging	Order Number
[A]					[mA]	[mΩ]	[W]		[g]		[ST]	

60A medical filter M5 and M80, design P, are only suitable for medical equipment intended for permanently connection to the mains.

Accessories

Description



[DIN_Rail_Kit](#)

Mounting accessory for compact 1- and 3-phase filters