

Products Catalog

**Conductive Polymer Tantalum
Solid Capacitors**

POSCAP

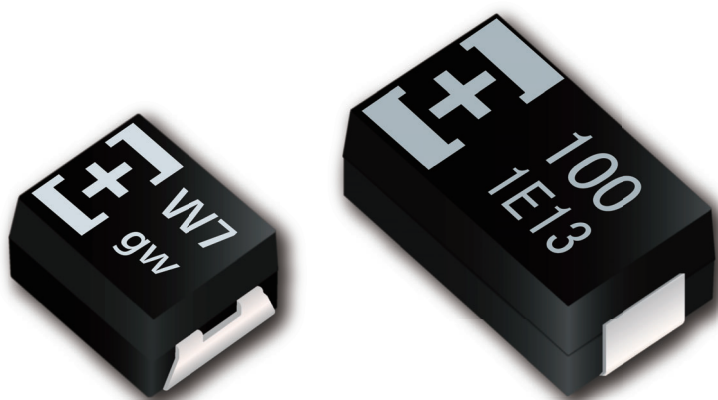

**IN Your
Future**



Conductive Polymer Tantalum Solid Capacitors INDEX

	Item	Page
	<u>Guidelines and precautions</u>	1
Selection guide	<u>Line up</u>	5
	<u>Diagram</u>	7
	<u>Explanation of part numbers</u>	8
	<u>Mounting specifications</u>	9
	<u>Packing specifications</u>	10
Series	<u>TLE series</u> : 125 °C 2000 h	11
	<u>TPG series</u> : Small size, Low profile	12
	<u>TPS series</u> : 105 °C 2000 h	13
	<u>TPSF series</u> : Super low ESR・Super low ESL	14
	<u>TPE (B size) series</u> : Small size	15
	<u>TPE (D size) series</u> : Low profile	17
	<u>TPF series</u> : Super low ESR	19
	<u>TQS series</u> : High voltage	21
	<u>TQC (B size) series</u> : High voltage	22
	<u>TQC (D size) series</u> : High voltage	24
	<u>TA series</u> : Guaranteed at 85 °C 85 %RH	26
	<u>TV series</u> : Guaranteed at 85 °C 85 %RH	28
	<u>TH series</u> : 125 °C 1000 h	29
	<u>TPB series</u> : Standard	31
	<u>TC series</u> : 125 °C 1000 h	33
	<u>TDC series</u> : 125 °C 1000 h	35
<u>TPC series</u> : Low profile	36	
	<u>Catalog Deletion Models</u>	38
	<u>EOL Models</u>	39

TPE/TPF/THC/TPC/TQC series some part numbers : Not recommended for new design

TPG series : Not recommended for new design

Guidelines and precautions regarding the technical information and use of our products described in this online catalog.

- If you want to use our products described in this online catalog for applications requiring special qualities or reliability, or for applications where the failure or malfunction of the products may directly jeopardize human life or potentially cause personal injury (e.g. aircraft and aerospace equipment, traffic and transportation equipment, combustion equipment, medical equipment, accident prevention, anti-crime equipment, and/or safety equipment), it is necessary to verify whether the specifications of our products fit to such applications. Please ensure that you will ask and check with our inquiry desk as to whether the specifications of our products fit to such applications use before you use our products.
- The quality and performance of our products as described in this online catalog only apply to our products when used in isolation. Therefore, please ensure you evaluate and verify our products under the specific circumstances in which our products are assembled in your own products and in which our products will actually be used.
- If you use our products in equipment that requires a high degree of reliability, regardless of the application, it is recommended that you set up protection circuits and redundancy circuits in order to ensure safety of your equipment.
- The products and product specifications described in this online catalog are subject to change for improvement without prior notice. Therefore, please be sure to request and confirm the latest product specifications which explain the specifications of our products in detail, before you finalize the design of your applications, purchase, or use our products.
- The technical information in this online catalog provides examples of our products' typical operations and application circuits. We do not guarantee the non-infringement of third party's intellectual property rights and we do not grant any license, right, or interest in our intellectual property.
- If any of our products, product specifications and/or technical information in this online catalog is to be exported or provided to non-residents, the laws and regulations of the exporting country, especially with regard to security and export control, shall be observed.

<Regarding the Certificate of Compliance with the EU RoHS Directive/REACH Regulations>

- The switchover date for compliance with the RoHS Directive/REACH Regulations varies depending on the part number or series of our products.
- When you use the inventory of our products for which it is unclear whether those products are compliant with the RoHS Directive/REACH Regulation, please select "Sales Inquiry" in the website inquiry form and contact us.

We do not take any responsibility for the use of our products outside the scope of the specifications, descriptions, guidelines and precautions described in this online catalog.

Notices

■ Applicable laws and regulations

- This product complies with the RoHS Directive (Restriction of the use of certain hazardous substances in electrical and electronic equipment (DIRECTIVE 2011/65/EU and (EU)2015/863)).
- No Ozone Depleting Chemicals(ODC's), controlled under the Montreal Protocol Agreement, are used in producing this product. We do not use PBBs or PBDEs as brominated flame retardants.
- Export procedure which followed export related regulations, such as foreign exchange and a foreign trade method, on the occasion of export of this product.
- These products are not dangerous goods on the transportation as identified by UN(United Nations) numbers or UN classification.

■ Limited applications

- This capacitor is designed to be used for electronics circuits such as audio/visual equipment, home appliances, computers and other office equipment, optical equipment, measuring equipment.
- An advanced specification must be signed individually for high-reliability use that might threaten human life or property due to a malfunction of the capacitor.

■ Intellectual property rights and licenses

- The technical information in this specification provides examples of our products' typical operations and application circuits. We do not guarantee the non-infringement of third party's intellectual property rights and we do not grant any license, right, or interest in our intellectual property.

Items to be observed

■ For specification

- This specification guarantees the quality and performance of the product as individual components. The durability differs depending on the environment and the conditions of usage. Before use, check and evaluate their compatibility with actual conditions when installed in the products. When safety requirements cannot be satisfied in your technical examination, inform us immediately.
- Do not use the products beyond the specifications described in this document.

■ Upon application to products where safety is regarded as important

Install the following systems for a fail-safe design to ensure safety if these products are to be used in equipment where a defect in these products may cause the loss of human life or other significant damage, such as damage to vehicles (automobile, train, vessel), traffic lights, medical equipment, aerospace equipment, electric heating appliances, combustion/ gas equipment, rotating rotating equipment, and disaster/crime prevention equipment.

- (1) The system is equipped with a protection circuit and protection device.
- (2) The system is equipped with a redundant circuit or other system to prevent an unsafe status in the event of a single fault.

■ Conditions of use

- Before using the products, carefully check the effects on their quality and performance, and determined whether or not they can be used. These products are designed and manufactured for general-purpose and standard use in general electronic equipment. These products are not intended for use in the following special conditions.
 - (1) In liquid, such as Water, Oil, Chemicals, or Organic solvent.
 - (2) In direct sunlight, outdoors, or in dust.
 - (3) In vapor, such as dew condensation water of resistive element, or water leakage, salty air, or air with a high concentration corrosive gas, such as Cl₂, H₂S, NH₃, SO₂, or NO_x.
 - (4) In an environment where strong static electricity or electromagnetic waves exist.
 - (5) Mounting or placing heat-generating components or inflammables, such as vinyl-coated wires, near these products.
 - (6) Sealing or coating of these products or a printed circuit board on which these products are mounted, with resin and other material.
 - (7) Using solvent, water or water-soluble cleaner for flux cleaning agent after soldering. (In particular, when using water or a water-soluble cleaning agent, be careful not to leave water residues)
 - (8) Using in the atmosphere where strays acid or alkaline.
 - (9) Using in the atmosphere where there are excessive vibration and shock.
 - (10) Using in the atmosphere where there are low pressure or decompression.
- Please arrange circuit design for preventing impulse or transitional voltage. Do not apply voltage, which exceeds the full rated voltage when the capacitors receive impulse voltage, instantaneous high voltage, high pulse voltage etc.
- Our products there is a product are using an electrolyte solution. Therefore, misuse can result in rapid deterioration of characteristics and functions of each product. Electrolyte leakage damages printed circuit and affects performance, characteristics, and functions of customer system.



Application Guidelines (POSCAP)

1. Circuit design

1.1 Prohibited circuits

Since problems can be expected, POSCAP cannot be used on the following circuits.

- (1) High impedance voltage retention circuits
- (2) Coupling circuit
- (3) Time constant circuits
- (4) Circuits greatly affected by leakage current
- (5) The circuit in which two or more POSCAP are connected in a series so as to raise the endurance voltage.

1.2 Failure and life-span

The failure rate is 0.5 %* / 1000 h (Confidence level : 60 %) based on JIS C 5003.

The mainly failure modes are as follows.

* B2 size or less : 1.0 %

1.2-1 Contingency failure

The main causes of failure are thermal stresses cause by the soldering or thermal use environment, along with heat stresses, electrical stresses or mechanical stresses. The most common failure mode is a short circuit.

In case a short circuit occurs, ensure safety by fully considering the followings.

- (a) If POSCAP emit smoke, turn off the main power of the equipment. In this case, keep your face and hands away from the area.
- (b) It may take a few seconds to a few minutes before POSCAP emits smoke by the situation. Increase safety by using a protective circuit.
- (c) If the smoke comes into eyes, rinse immediately. If the smoke is inhaled, gargle immediately.
- (d) In case a large current continues to flow after a short circuit, in the worst case, the shorted-out section may ignite. For safety, install a redundant circuit or a protective circuit, etc.

1.2-2 Wear-out failure (lifetime)

When lifetime exceeded the specified guarantee time of Endurance and Damp heat, electrolyte might insulate and cause electric characteristic changed. This is called an open circuit. The rated capacitance values and the electrical characteristics values such as ESR specified in the characteristics list are factory default values. Please carefully design a circuit since rated capacitance values and the electrical characteristics values may change (increase) beyond the specified values under the conditions of rated voltage/temperature and electrical/mechanical performances.

1.3 Reduction of failure stress

When POSCAP is used within the rated voltage, it shows a stable characteristic, but it may be damaged in a short circuit when an overvoltage, for instance, is applied. The time to reach the failure mode can be extended by using POSCAP with reduced environment temperature, ripple current and applied voltage.

Failure rate

- In the case of the endurance which is 105 °C 2000 h.
0.5 %/1000 h (Environment temp. : 105 °C, Rated voltage or Category voltage applied)
- In the case of the endurance which is 105 °C 1000 h or 125 °C 1000 h.
1.0 %/1000 h (Environment temp. : 105 °C, Rated voltage or Category voltage applied)
- In the case of the endurance which is 85 °C 1000 h.
1.0 %/1000 h (Environment temp. : 85 °C, Rated voltage applied)

1.4 Check the rated performance

After checking the operation and installation environments, design the circuit so that it falls within the rated performance range stipulated in this delivery specification.

1.5 Operating temperature and ripple current

- (1) Set the operating temperature so that it falls within the range stipulated in this delivery specification.
- (2) Do not apply current that exceeds the allowable ripple current. Ripple current should be controlled so that surface temperature of a capacitor do not exceed the rated temperature.
(For questions regarding TQC series, please contact us.)
- (3) The ESR values specified in the characteristics list are factory default values.
ESR values may change (increase) beyond the specified values depending on the customer's use conditions.

1.6 Leakage current

Even when the soldering conditions fall within the range of this delivery specifications, leakage current increases a little on occasion. It also increases a little during high temperature storage, high humidity storage and temperature cycling with no voltage applied. In cases such as these, leakage current will decrease by applying voltage under the condition of below the POSCAP's maximum operating temperature.

The speed at which the leakage current is restored is increased by applying voltage when the POSCAP's temperature is close to the maximum operating temperature.

1.7 Rapid charge and discharge limitation

Rapid charge and discharge are restricted (for maintenance of high-proof reliability).

A protective circuit is recommended for when a rapid charge or discharge causes excessive rush current since this is main cause of short circuit and large leakage current. Use a protective circuits in case the rush current value exceeds 20 A*.

Be sure to insert a protection resistor of about 1 kΩ for charge and discharge when measuring the leakage current.

* When TH series use under the ambient temperature more than 105 °C : 10 A, TPU series : 10 A

2. Mounting

2.1 Protect circuit

The failure mode of POSCAP is the short mode. When it breaks down, short electric current flows to it.

POSCAP gives off heat by this short current.

Do the following consideration in design fully for the safety because it has a bad influence on the part around POSCAP due to this heat.

- A protective circuit and a protective device are set up, so as to make the system safer.
- A diffuse circuit and so on is set up, so as to make the system safer such as that a machine may not break down as to the single trouble.

2.2 Considerations when soldering

The soldering conditions are to be within the range prescribed in this delivery specification.

If the specifications are not followed, there is the possibility of degradation of electric characteristic and lifetime when soldering is conducted under conditions that are harsher than those stipulated.

2.3 Others

POSCAP's Electrical characteristics are affected by temperature and frequency fluctuations.

Design circuits after checking the amount of fluctuation.

3. Storage

It is necessary to set an environment to prevent a trouble at the time of soldering by the degradation of solder ability or moisture's getting into the molding resin when POSCAP are stored.

- Please make storage of POSCAP sealing up in the reel and the moisture proof bag at the time of delivery in the following environment. Also, set storage period of unopened as 18 months or shorter after shipment from factory.
 - Room temperature and room humidity (generally : 15 to 35 °C, 45 to 75% RH) are desirable.
 - Place where POSCAP is not exposed by direct sunshine.
- Please unseal the moisture proof bag just before mounting and use up POSCAP in the moisture proof bag. Storage conditions after opening the moisture proof bag are as follows.

Floor life		
Level	Time	Conditions
2a	4 weeks	≤ 30 °C / 60 %RH
3	168 hours	≤ 30 °C / 60 %RH
5	48 hours	≤ 30 °C / 60 %RH

POSCAP is not compatible with JEDEC J-STD-020, J-STD-033

* Intellectual property right

We, Panasonic Group are providing the product and service that customers can use without anxiety, and are working positively on the protection of our products under intellectual property rights.

Representative patents relating to POSCAP are as follows:

US Patent No.6508800, No.6891717, No.7158368, No.7326260号, No.8081421, No.8149569, No.8456804, No.8559166

Line up

Series	Features	Small size/Low profile	Large capacitance	Low ESR	High reliability	High voltage	Guaranteed at 125°C	Category temp. range (°C)	Rated voltage (V)	ESR (mΩ)	Capacitance (μF)	Size code	Size (mm)		
													L	W	H
NEW TLE	Guaranteed at 125 °C 2000 h						●	-55 to 125	2.5 to 6.3	12 to 35	100 to 330	B2	3.5	2.8	1.9
TPG	Small size Low profile Large capacitance	●	●					-55 to 105	2.5 to 12.5	35 to 70	33 to 220	B1G	3.5	2.8	1.1
								-55 to 105	2.5 to 6.3	30 to 70	150 to 220	B15G	3.5	2.8	1.4
TPS	Small size/Low profile Large capacitance Face down terminal	●	●					-55 to 105	2.5 to 6.3	30 to 35	150 to 330	B1S	3.5	2.8	1.1
TPSF	Low ESR/Small size Large capacitance Face down terminal	●	●	●				-55 to 105	2.0 to 2.5	6 to 9	270	B2S	3.5	2.8	1.9
TPE	Low ESR							-55 to 105	2.0 to 10	9 to 70	47 to 470	B2	3.5	2.8	1.9
								-55 to 105	6.3	35	470	D15E	7.3	4.3	1.4
								-55 to 105	2.5 to 10	7 to 45	68 to 470	D2E	7.3	4.3	1.8
								-55 to 105	2.5 to 10	9 to 40	150 to 680	D3L	7.3	4.3	2.8
								-55 to 105	2.5 to 10	10 to 40	330 to 1500	D4	7.3	4.3	3.8
TPF	Low ESR Large capacitance							-55 to 105	2.0	6	220 to 330	D2E	7.3	4.3	1.8
								-55 to 105	2.5 to 10	5 to 25	150 to 680	D3L	7.3	4.3	2.8
								-55 to 105	2.5 to 6.3	5 to 35	470 to 1000	D4	7.3	4.3	3.8
TQS	High voltage	●					●	-55 to 105	35	100	47	D15S	7.3	4.3	1.4
TQC	High voltage							-55 to 105	16 to 35	90 to 400	3.9 to 47	B2	3.5	2.8	1.9
								-55 to 105	16	40	33	D12	7.3	4.3	1.15
								-55 to 105	16 to 25	55 to 70	22 to 47	D15	7.3	4.3	1.4
								-55 to 105	16 to 35	40 to 150	10 to 150	D2	7.3	4.3	1.9
								-55 to 105	16 to 25	50 to 70	68 to 220	D3L	7.3	4.3	2.8
TA	High reliability							-55 to 105	4.0 to 10	70	47 to 100	B2	3.5	2.8	1.9
								-55 to 105	2.5 to 10	9 to 25	68 to 470	D2E	7.3	4.3	1.8
								-55 to 105	2.5 to 10	15 to 25	150 to 680	D3L	7.3	4.3	2.8
TV	High reliability Guaranteed at 125 °C							-55 to 125	6.3 to 10	25	68 to 150	D2E	7.3	4.3	1.8
								-55 to 125	10	25	150	D3L	7.3	4.3	2.8

TPE/TPF/THC/TPC/TQC series some part numbers : Not recommended for new design
TPG series : Not recommended for new design

Line up

Series	Features	Small size/Low profile	Large capacitance	Low ESR	High reliability	High voltage	Guaranteed at 125°C	Category temp. range (°C)	Rated voltage (V)	ESR (mΩ)	Capacitance (μF)	Size code	Size (mm)		
													L	W	H
TPB	Standard							-55 to 105	4.0 to 10	70	33 to 68	B2	3.5	2.8	1.9
								-55 to 105	4.0 to 10	40 to 55	150 to 330	D3L	7.3	4.3	2.8
								-55 to 105	6.3 to 10	35 to 40	220 to 470	D4	7.3	4.3	3.8
TH	Guaranteed at 125 °C						●	-55 to 125	2.5 to 6.3	15 to 25	150 to 330	D2E	7.3	4.3	1.8
								-55 to 125	2.5 to 10	40 to 45	68 to 220	D2	7.3	4.3	1.9
								-55 to 125	4.0 to 6.3	40	220 to 330	D3L	7.3	4.3	2.8
								-55 to 125	6.3 to 10	35 to 40	220 to 470	D4	7.3	4.3	3.8
TC	Guaranteed at 125 °C						●	-55 to 125	2.5	9	330	B2	3.5	2.8	1.9
								-55 to 125	4.0 to 6.3	15 to 25	100 to 330	D2E	7.3	4.3	1.8
								-55 to 125	2.5 to 10	5 to 25	150 to 680	D3L	7.3	4.3	2.8
								-55 to 125	2.5 to 10	5 to 25	330 to 1000	D4	7.3	4.3	3.8
TDC	High voltage Guaranteed at 125 °C						● ●	-55 to 125	16 to 25	90 to 100	15 to 33	B2	3.5	2.8	1.9
								-55 to 125	16	50	100	D2	7.3	4.3	1.9
								-55 to 125	16 to 25	50 to 70	68 to 150	D3L	7.3	4.3	2.8
TPC	Low profile	●						-55 to 105	6.3 to 12.5	55 to 80	10 to 47	B1	3.5	2.8	1.1
								-55 to 105	6.3 to 10	40 to 100	68 to 330	D2	7.3	4.3	1.9

TPE/TPF/THC/TPC/TQC series some part numbers : Not recommended for new design

TPG series : Not recommended for new design

Explanation of part numbers

◇ Part number system

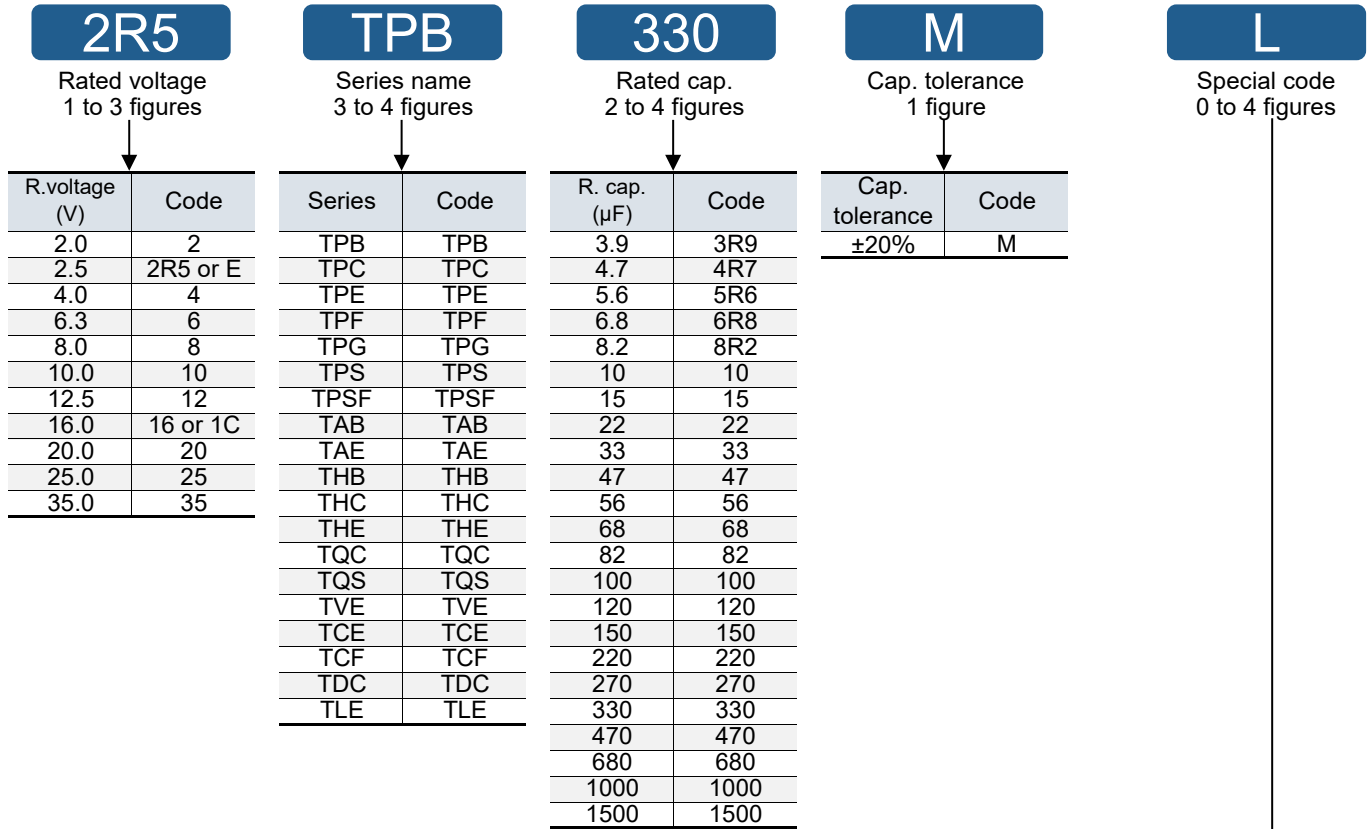

Standard		Code
TPE series		
B2	ESR 35 mΩ max.	ZB
	ESR 25 mΩ max.	PB
	ESR 21 mΩ max.	LB
	ESR 15 mΩ max.	FB
	ESR 15 mΩ / 300 kHz max.	FGB
	ESR 35 mΩ max. 85°C	AZB
	ESR 25 mΩ max. 85°C	APB
	ESR 15 mΩ max. 85°C	AFB
	ESR 13 mΩ / 300 kHz max. 85°C	ADGB
	ESR 11 mΩ / 300 kHz max. 85°C	AJGB
D15E	ESR 35 mΩ max. 85°C	AZU
D2E	ESR 25 mΩ max. 85°C	AP
D3L	ESR 25 mΩ max.	L
	ESR 18 mΩ max.	IL
	ESR 15 mΩ max.	FL
	ESR 12 mΩ max.	CL
	ESR 10 mΩ max.	AL
	ESR 25 mΩ max. 85°C	AL
	ESR 9 mΩ / 500 kHz max. 85°C	A9EL
TPG series		
B1G	ESR 35 mΩ / 300 kHz max.	ZGD
TPB series		
D3L		L
TPC series		
85 °C		A
B1		B
TQS series		
D15S	ESR 100 mΩ / Height 1.5 mm max.	EU
TLE series		
B2	ESR 35 mΩ max.	ZB
	ESR 12 mΩ / 300 kHz max.	CGB

Standard		Code
TPF series		
D3L	ESR 9 mΩ max.	9L
	ESR 7 mΩ max.	7L
	ESR 6 mΩ max.	6L
	ESR 5 mΩ max.	5L
D4	ESR 10 mΩ max.	AH
	ESR 6 mΩ max.	6H
	ESR 5 mΩ max.	5H
TQC / TDC series		
Capacitance enlarged type		YF
Capacitance enlarged type (B2 size)		YFB
Capacitance enlarged type (D12 size)		YFS
Capacitance enlarged type (D15 size)		YFT
Capacitance enlarged type (D2 size)		YFD/D2
Capacitance enlarged type (D3L size)		D3
All series		
ESR 55 mΩ max.		G
ESR 45 mΩ max.		V
ESR 40 mΩ max.		W
ESR 35 mΩ max.		Z
ESR 18 mΩ max.		I
ESR 15 mΩ max.		F
ESR 12 mΩ max.		C
ESR 9 mΩ max.		9
ESR 7 mΩ max.		7
ESR 6 mΩ max.		6
ESR 5 mΩ max.		5
ESR 35 mΩ / 300 kHz max.		ZG
ESR 30 mΩ / 300 kHz max.		UG
ESR 9 mΩ / 300 kHz max.		9G
ESR 6 mΩ / 500 kHz max.		6E
ESR 4 mΩ / 500 kHz max.		4E

TPE/TPF/THC/TPC/TQC series some part numbers : Not recommended for new design
 TPG series : Not recommended for new design

Mounting specifications

◆ **Recommendable reflow soldering**

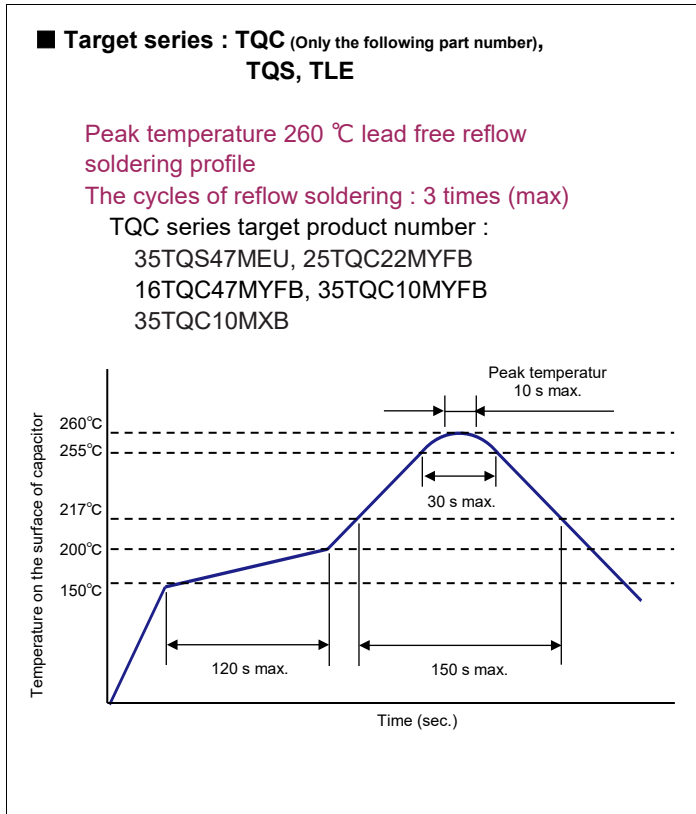
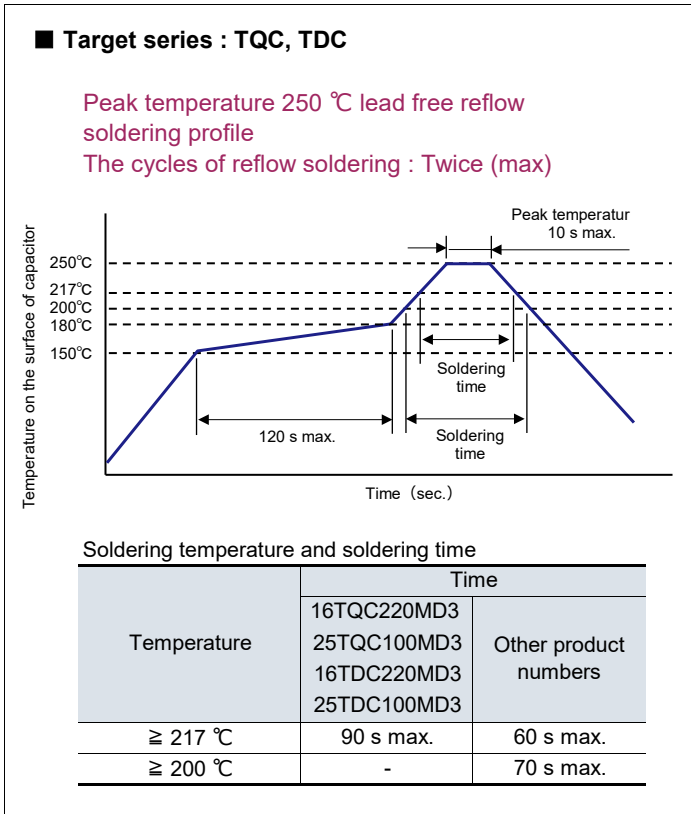
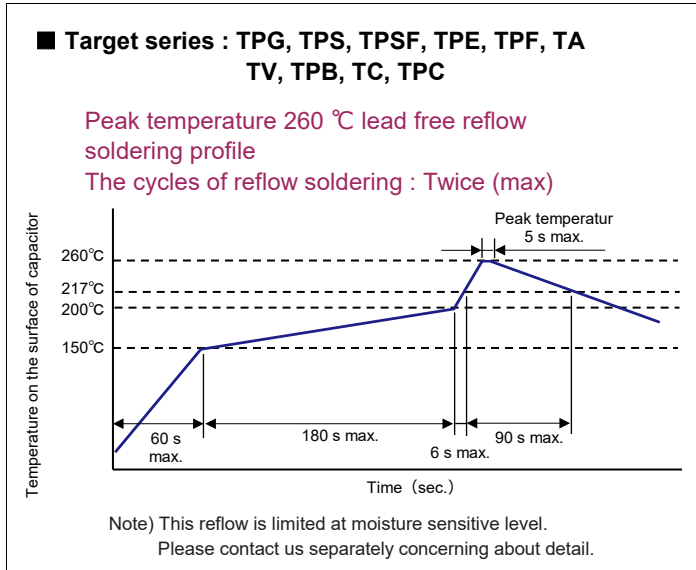
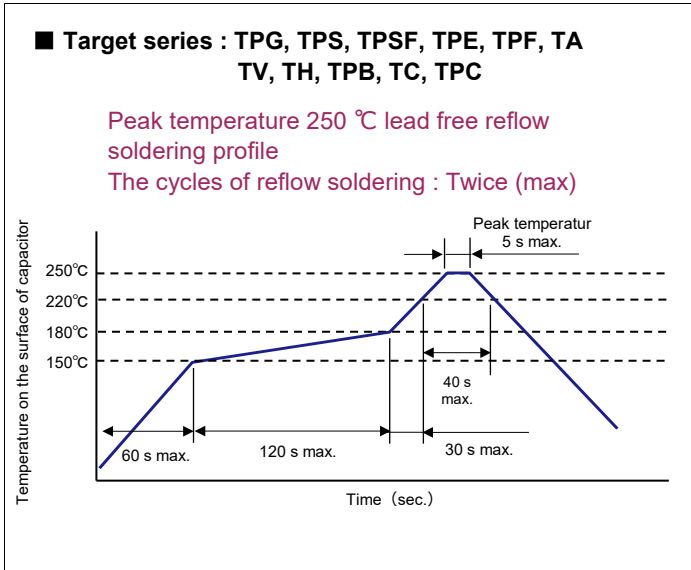

● **Soldering with a soldering iron**

- Tip of a soldering iron : 350 °C max (TQC / TQS series : 400 °C max.)
- Power of a soldering iron : 30 W max.
- Working time : 3 sec. max. (TQC / TQS series : 5 sec. max.)

(Do not let the tip of soldering iron touch the POSCAP itself. Do not subject the POSCAP itself to excessive stress when soldering)

Land pattern

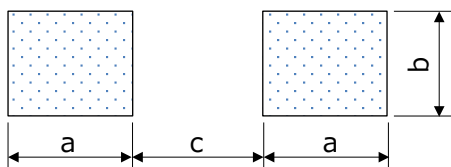

Unit : mm

Size code	a	b	c
B1, B1S, B1G, B15G, B2, B2S	1.6	2.7	1.4
D12, D15, D15E, D2E, D2, D3L, D4	2.4	2.9	3.7
D15S	1.4 / 1.7 ^{*1}	2.6	4.6

B15G, D12 size : Not recommended for new design

*1 : +side / -side

Packing specifications

◇ Dimension of carrier tape

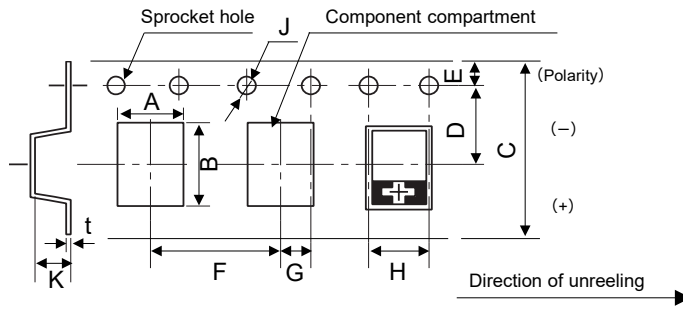

Unit : mm

Size code	A±0.1	B±0.1	C±0.3	D±0.05	E±0.1	F±0.1	G±0.05	H±0.1	J $\begin{smallmatrix} +0.1 \\ -0 \end{smallmatrix}$	K±0.1	t±0.05
B1	3.2	3.8	8.0	3.5	1.75	4.0	2.0	4.0	∅1.5	1.4	0.25
B1S	3.25	3.9	8.0	3.5	1.75	4.0	2.0	4.0	∅1.5	1.7	0.25
B1G	3.25	3.9	8.0	3.5	1.75	4.0	2.0	4.0	∅1.5	1.7	0.25
B15G	3.25	3.9	8.0	3.5	1.75	4.0	2.0	4.0	∅1.5	1.7	0.25
B2	3.3	3.8	8.0	3.5	1.75	4.0	2.0	4.0	∅1.5	2.1	0.25
B2S	3.25	4.0	8.0	3.5	1.75	4.0	2.0	4.0	∅1.5	2.1	0.25
D12	4.5	7.5	12.0	5.5	1.75	8.0	2.0	4.0	∅1.5	1.7	0.3
D15	4.5	7.5	12.0	5.5	1.75	8.0	2.0	4.0	∅1.5	2.4	0.3
D15E, D15S	4.7	7.8	12.0	5.5	1.75	8.0	2.0	4.0	∅1.5	1.7	0.3
D2E	4.5	7.5	12.0	5.5	1.75	8.0	2.0	4.0	∅1.5	2.4	0.3
D2	4.5	7.5	12.0	5.5	1.75	8.0	2.0	4.0	∅1.5	2.4	0.3
D3L	4.5	7.7	12.0	5.5	1.75	8.0	2.0	4.0	∅1.5	3.2	0.3
D4	4.5	7.7	12.0	5.5	1.75	8.0	2.0	4.0	∅1.5	4.2	0.3

- Dimension A and B are the measure of compartment's inside bottom.
- The (+) Polarity of the chip is placed on right side towards the unreeling direction.
- Dimension of the topcover tape.
Thickness of cover tape: 62±10 μm, Width of cover tape : 9.5±0.2 mm 5.5±0.2 mm (∅180)

B15G, D12 size : Not recommended for new design

◇ Reel dimension

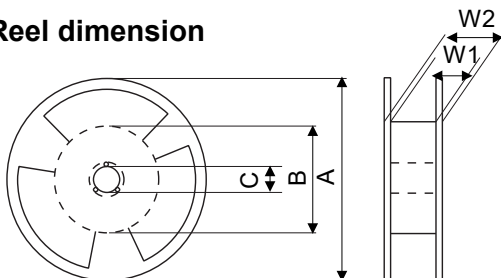

Unit : mm

A	B	C	W1	W2
∅330±2	∅80±2	∅13.0±0.2	13.5±0.5	17.5±1.0
∅180 $\begin{smallmatrix} 0 \\ -3 \end{smallmatrix}$	∅60±2	∅13.0±0.2	9.0±0.5	11.4±1.0

◇ Minimum packing quantity and weight

(∅180)

Size code	Qty. (pcs./Reel)	Typical weight (g)
B1	3000	200
B1S, B1G	2500	200
B15G	2500	200
B2, B2S	2000	200

(∅330)

Size code	Qty. (pcs./Reel)	Typical weight (g)
D12	4500	1200
D15	3000	1000
D15E, D15S	4000	1000
D2E, D2	3000	1000
D3L	2500	1100
D4	2000	1200

※ Small order quantity (500 pcs/reel) is available with TPE, TPF and TQC series.
Please contact our sales representative if you prefer it.

B15G, D12 size : Not recommended for new design

◇ Dimension of packing case

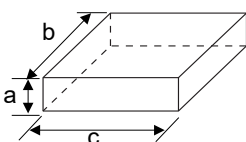

Unit : mm

Reel size	∅180	∅330
a	90	120
b	240	360
c	240	360

◇ Units per packing case

Size code	Pieces/case	Size code	Pieces/case
B1	15000	D12	22500
B1S, B1G	12500	D15	15000
B15G	12500	D15E, D15S	20000
B2, B2S	10000	D2E, D2	15000
B15G, D12 size			
: Not recommended for new design			
		D3L	12500
		D4	10000



Conductive Polymer Tantalum Solid Capacitors

Surface Mount Type

TLE series

Features

- 125 °C 2000 h
- Small size (L 3.5 × W 2.8 × H 1.9 mm)
- RoHS compliance, Halogen free

Specifications

Size code	B2	
Category temp. range	-55 °C to +125 °C	
Rated volt. range	2.5 V to 6.3 V	
Category volt. range	2.0 V to 5.0 V	
Rated cap. range	100 μF to 330 μF	
Capacitance tolerance	±20 % (120 Hz / +20 °C)	
Leakage current	Please see the attached characteristics list	
Dissipation factor(tan δ)	Please see the attached characteristics list	
Surge voltage (V)	Rated voltage × 1.15	
Endurance	+125 °C 2000 h category voltage applied	
	Capacitance change	Within ±20 % of the initial value
	Dissipation factor(tan δ)	≤ 1.5 times of the initial limit
	Leakage current	≤ 3 times of the initial limit
Damp heat (Steady State)	+60 °C, 90 % to 95 % RH, 500 h, No-applied voltage	
	Capacitance change	Within +40 % (ETLE30MCGB: +50 %), -20 % of the initial value
	Dissipation factor(tan δ)	≤ 1.5 times of the initial limit
	Leakage current	≤ 3 times of the initial limit

Marking

Rated voltage code

Polarity marking (+)

Rated capacitance code

Lot. No.

R.voltage code	Unit : V	R.capacitance code	Unit : μF
e	2.5	A8	100
j	6.3	N8	330

Dimensions (not to scale)

Size code	L±0.2	W±0.2	H±0.1	S±0.2	W1±0.1
B2	3.5	2.8	1.9	0.8	2.2

Unit : mm

* Externals of figure are the reference.

Characteristics list

Rated voltage (V)	Rated temperature (°C)	Category voltage (V)	Category temperature (°C)	Rated capacitance (μF)	Case size (mm)			Size code	Specifications				Standard		Floor life level	
					L	W	H		Ripple ^{*1} current (mA rms)	ESR ^{*2} (mΩ max.)	tan δ ^{*3}	LC ^{*4} (μA)	Part number	Min. packaging q'ty (pcs)	Reflow temp ≤260°C	Reflow temp ≤250°C
2.5	105	2.0	125	330	3.5	2.8	1.9	B2	2770	12 / 300kHz	0.08	165.0	ETLE330MCGB	2000	3	3
6.3	105	5.0	125	100	3.5	2.8	1.9		1400	35	0.08	126.0	6TLE100MZB	2000		

*1: Ripple current (100 kHz / +45 °C)

*2: ESR (100 kHz / +20 °C)

*3: tan δ (120 Hz / +20 °C)

*4: After 5 minutes

◆ Please refer to each page in this catalog for "Reflow conditions", "Taping specifications" and "Floor life level".

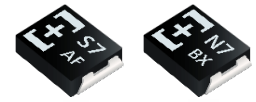

Conductive Polymer Tantalum

Solid Capacitors

Surface Mount Type

TPG series

Features

- Small size, Low profile (L 3.5 × W 2.8 × H 1.1 mm)
- Large capacitance (220 μF max.)
- RoHS compliance, Halogen free

Specifications

Size code	B1G	B15G
Category temp. range	-55 °C to +105 °C	
Rated volt. range	2.5 V to 12.5 V	2.5 V to 6.3 V
Category volt. range	2.0 V to 10 V	2.0 V to 5.0 V
Rated cap. range	33 μF to 220 μF	150 μF to 220 μF
Capacitance tolerance	±20 % (120 Hz / +20 °C)	
Leakage current	Please see the attached characteristics list	
Dissipation factor(tan δ)	Please see the attached characteristics list	
Surge voltage (V)	Rated voltage × 1.15	
Endurance	+85 °C 1000 h rated voltage applied	
	Capacitance change	Within ±20 % of the initial value
	Dissipation factor(tan δ)	≤ 1.5 times of the initial limit
	Leakage current	Within the initial limit
Damp heat (Steady State)	+60 °C, 90 % to 95 % RH, 500 h, No-applied voltage	
	Capacitance change	Within +40 %, -20 % of the initial value
	Dissipation factor(tan δ)	≤ 1.5 times of the initial limit
	Leakage current	≤ 3 times of the initial limit

Marking

Polarity marking (+) Rated Capacitance code

Rated Voltage code Lot. No.

R. voltage code	Value	R. capacitance code	Value	Unit
e	2.5	j	6.3	Unit : V
g	4.0	k	8.0	
		A	10	Unit : μF
		B	12.5	
		N7	33	Unit : μF
		S7	47	
		A8	100	Unit : μF
		E8	150	
		J8	220	

Dimensions (not to scale)

Size code	L ^{+0.3} _{-0.1}	W ^{+0.3} _{-0.1}	H±0.1	S±0.2	W1±0.1
B1G	3.5	2.8	1.1	0.8	2.2
B15G	3.5	2.8	1.4	0.8	2.2

Unit : mm

* Externals of figure are the reference.

Characteristics list

Rated voltage (V)	Rated temperature (°C)	Category voltage (V)	Category temperature (°C)	Rated capacitance (μF)	Case size (mm)			Size code	Specifications				Standard		Floor life level	
					L	W	H		Ripple ^{*1} current (mA rms)	ESR ^{*2} (mΩ max.)	tan δ ^{*3}	LC ^{*4} (μA)	Part number ^{*5}	Min. packaging q'ty (pcs)	Reflow temp ≤260°C	Reflow temp ≤250°C
2.5	85	2.0	105	220	3.5	2.8	1.1	B1G	1000	70	0.10	55	2R5TPG220M	2500	3	3
	85	2.0	105		3.5	2.8	1.4	B15G	1400	30/300 kHz	0.10	110	2R5TPG220MUG	2500		
4.0	85	3.2	105	220	3.5	2.8	1.4	B15G	1000	70	0.10	88	4TPG220M	2500		
	85	5.0	105		3.5	2.8	1.1	B1G	1000	70	0.10	63	6TPG100M	2500		
6.3	85	5.0	105	100	3.5	2.8	1.1	B1G	1100	55	0.10	63	6TPG100MG	2500		
	85	5.0	105		3.5	2.8	1.1	B15G	1200	35/300 kHz	0.10	126	6TPG100MZGD	2500		
	85	5.0	105	150	3.5	2.8	1.4	B15G	1000	70	0.10	94.5	6TPG150M	2500		
	85	5.0	105		3.5	2.8	1.4	B15G	1200	35/300 kHz	0.10	189	6TPG150MZG	2500		
8.0	85	6.3	105	47	3.5	2.8	1.1	B1G	1000	70	0.10	37.6	8TPG47M	2500		
10	85	8.0	105	47	3.5	2.8	1.1	B1G	1000	70	0.10	47	10TPG47M	2500		
12.5	85	10	105	33	3.5	2.8	1.1	B1G	1000	70	0.10	41.3	12TPG33M	2500		

*1: Ripple current (100 kHz / +45 °C)

*2: ESR (100 kHz / +20 °C)

*3: tan δ (120 Hz / +20 °C)

*4: After 5 minutes

*5: Compatible products available

◆ Please refer to each page in this catalog for "Reflow conditions", "Taping specifications" and "Floor life level".

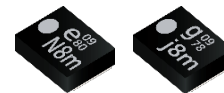

Conductive Polymer Tantalum Solid Capacitors

Surface Mount Type

TPS series

Features

- 105 °C 2000 h
- Small size, Low profile (L 3.5 × W 2.8 × H 1.2 mm max.)
- RoHS compliance, Halogen free

Specifications

Size code	B1S	
Category temp. range	-55 °C to +105 °C	
Rated volt. range	2.5 V to 6.3 V	
Category volt. range	2.5 V to 6.3 V	
Rated cap. range	150 μF to 330 μF	
Capacitance tolerance	±20 % (120 Hz / +20 °C)	
Leakage current	Please see the attached characteristics list	
Dissipation factor(tan δ)	Please see the attached characteristics list	
Surge voltage (V)	Rated voltage × 1.15	
Endurance	+105 °C 2000 h rated voltage applied	
	Capacitance change	Within ±20 % of the initial value
	Dissipation factor(tan δ)	≤ 1.5 times of the initial limit
	Leakage current	Within the initial limit
Damp heat (Steady State)	+60 °C, 90 % to 95 % RH, 500 h, No-applied voltage	
	Capacitance change	Within +40 %, -20 % of the initial value
	Dissipation factor(tan δ)	≤ 1.5 times of the initial limit
	Leakage current	≤ 3 times of the initial limit

Marking

Rated voltage code Unit : V

e	2.5
g	4.0
j	6.3

R.capacitance code Unit : μF

E8	150
J8	220
N8	330

Dimensions (not to scale)

Unit : mm

Size code	L±0.2	W±0.2	H±0.1	S±0.3	W1±0.1
B1S	3.5	2.8	1.1	0.8	2.2

* Externals of figure are the reference.

Characteristics list

Rated voltage (V)	Rated temperature (°C)	Category voltage (V)	Category temperature (°C)	Rated capacitance (μF)	Case size (mm)			Size code	Specifications				Standard		Floor life level	
					L	W	H		Ripple current ¹ (mA rms)	ESR ² (mΩ max.)	tan δ ³	LC ⁴ (μA)	Part number	Min. packaging qty (pcs)	Reflow temp ≤260°C	Reflow temp ≤250°C
2.5	105	2.5	105	220	3.5	2.8	1.1	B1S	1400	30	0.10	55.0	ETPS220MUD	2500	3	3
	105	2.5	105	330	3.5	2.8	1.1		1400	30	0.10	82.5	ETPS330MUD	2500		
4.0	105	4.0	105	220	3.5	2.8	1.1		1400	30	0.10	88.0	4TPS220MUD	2500		
	105	6.3	105	150	3.5	2.8	1.1		1400	30	0.10	94.5	6TPS150MUD	2500		
6.3	105	6.3	105		3.5	2.8	1.1		1250	35	0.10	94.5	6TPS150MZD	2500		

*1: Ripple current (100 kHz / +45 °C)

*2: ESR (100 kHz / +20 °C)

*3: tan δ (120 Hz / +20 °C)

*4: After 5 minutes

◆ Please refer to each page in this catalog for "Reflow conditions", "Taping specifications" and "Floor life level".

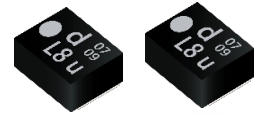

Conductive Polymer Tantalum Solid Capacitors

Surface Mount Type

TPSF series

Features

- Super low ESR (6 mΩ max.)
- Super low ESL (0.7 nH max.)
- Face down terminal type
- RoHS compliance, Halogen free

Specifications

Size code	B2S	
Category temp. range	-55 °C to +105 °C	
Rated volt. range	2.0 V to 2.5 V	
Category volt. range	2.0 V to 2.5 V	
Rated cap. range	270 μF	
Capacitance tolerance	±20 % (120 Hz / +20 °C)	
Leakage current	Please see the attached characteristics list	
Dissipation factor(tan δ)	Please see the attached characteristics list	
Surge voltage (V)	Rated voltage × 1.15	
Endurance	+105 °C 1000 h rated voltage applied	
	Capacitance change	Within ±20 % of the initial value
	Dissipation factor(tan δ)	≤ 1.5 times of the initial limit
	Leakage current	Within the initial limit
Damp heat (Steady State)	+60 °C, 90 % to 95 % RH, 500 h, No-applied voltage	
	Capacitance change	Within +40 %, -20 % of the initial value
	Dissipation factor(tan δ)	≤ 1.5 times of the initial limit
	Leakage current	≤ 3 times of the initial limit

Marking

Rated voltage code

Polarity marking (+)

Rated capacitance code

Lot. No.

R.voltage code	Unit : V
d	2.0
e	2.5

R.capacitance code	Unit : μF
L8	270

Dimensions (not to scale)

Size code	L±0.2	W±0.2	H±0.1	S±0.3	W1±0.1
B2S	3.5	2.8	1.9	0.8	2.2

Unit : mm

* Externals of figure are the reference.

Characteristics list

Rated voltage (V)	Rated temperature (°C)	Category voltage (V)	Category temperature (°C)	Rated capacitance (μF)	Case size (mm)			Size code	Specifications				Standard		Floor life level	
					L	W	H		Ripple current ^{*1} (mA rms)	ESR ^{*2} (mΩ max.)	tan δ ^{*3}	LC ^{*4} (μA)	Part number	Min. packaging q'ty (pcs)	Reflow temp ≤260°C	Reflow temp ≤250°C
2.0	105	2.0	105	270	3.5	2.8	1.9	B2S	3200	6/500 kHz	0.08	108.0	2TPSF270M6E	2000	5	5
	105	2.0	105		3.5	2.8	1.9		2400	9/300 kHz	0.08	108.0	2TPSF270M9G	2000	3	3
2.5	105	2.5	105		3.5	2.8	1.9		3200	6/500 kHz	0.08	135.0	ETPSF270M6E	2000		

*1: Ripple current (100 kHz / +45 °C) *2: ESR (100 kHz / +20 °C) *3: tan δ (120 Hz / +20 °C) *4: After 5 minutes

◆ Please refer to each page in this catalog for "Reflow conditions", "Taping specifications" and "Floor life level".



Some part numbers are not a recommended product.
Not recommended for new design.

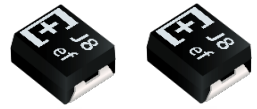

Conductive Polymer Tantalum

Solid Capacitors

Surface Mount Type

TPE series B size

Features

- Small size (L 3.5 × W 2.8 × H 1.9 mm)
- Low ESR (15 mΩ max.)
- RoHS compliance, Halogen free

Specifications

Size code	B2	
Category temp. range	-55 °C to +105 °C	
Rated volt. range	2.0 V to 10 V	
Category volt. range	1.8 V to 8 V	
Rated cap. range	47 μF to 470 μF	
Capacitance tolerance	±20 % (120 Hz / +20 °C)	
Leakage current	Please see the attached characteristics list	
Dissipation factor(tan δ)	Please see the attached characteristics list	
Surge voltage (V)	Rated voltage × 1.15	
Endurance	+105 °C 1000 h rated voltage applied	
	Rated temp, +85 °C Products : +85 °C 1000 h, rated voltage applied	
	Capacitance change	Within ±20 % of the initial value
	Dissipation factor(tan δ)	≤ 1.5 times of the initial limit
Damp heat (Steady State)	+60 °C, 90 % to 95 % RH, 500 h, No-applied voltage	
	Capacitance change	Within +50 %, -20 % of the initial value (2R5TPE220MAZB (MAPB, MAFB), 2R5TPE330MAZB, 2TPE330MAFB (MADGB), 2TPE470MAJGB (MAFB), 2TPE330MFB, ETPE330MAFB (MA9GB))
		Within +40 %, -20 % of the initial value (Except for above model)
	Dissipation factor(tan δ)	≤ 1.5 times of the initial limit
	Leakage current	≤ 3 times of the initial limit

Marking

Rated capacitance code

Polarity marking (+)

Rated voltage code

Lot No.

R. voltage code		Unit : V	
d	2.0	g	4.0
e	2.5	j	6.3
		k	8.0
		A	10

R. capacitance code		Unit : μF	
S7	47	E8	150
A8	100	J8	220
C8	120	N8	330
		S8	470

Dimensions (not to scale)

Size code	L±0.2	W±0.2	H±0.1	S±0.2	W1±0.1
B2	3.5	2.8	1.9	0.8	2.2

Unit : mm

* Externals of figure are the reference.

Characteristics list

Rated voltage (V)	Rated temperature (°C)	Category voltage (V)	Category temperature (°C)	Rated capacitance (μF)	Case size (mm)			Size code	Specifications				Standard		Floor life level		
					L	W	H		Ripple current ^{*1} (mA rms)	ESR ^{*2} (mΩ max.)	tan δ ^{*3}	LC ^{*4} (μA)	Part number	Min. packaging q'ty (pcs)	Reflow temp ≤260°C	Reflow temp ≤250°C	
2.0	NRFND 105	2.0	105	330	3.5	2.8	1.9	B2	2000	15	0.08	132.0	2TPE330MFB	2000	3	3	
	NRFND 85	1.8	105		3.5	2.8	1.9		2000	15	0.08	132.0	2TPE330MAFB	2000			
	NRFND 85	1.8	105		3.5	2.8	1.9		2000	13/300kHz	0.10	132.0	2TPE330MADGB	2000			
	85	1.8	105	470	3.5	2.8	1.9	B2	2300	15	0.10	188.0	2TPE470MAFB	2000	3	3	
	85	1.8	105		3.5	2.8	1.9		2300	11/300kHz	0.08	188.0	2TPE470MAJGB	2000			
2.5	85	2.0	105	220	3.5	2.8	1.9	B2	2000	15	0.08	110.0	2R5TPE220MAFB	2000	3	3	
	105	2.5	105		3.5	2.8	1.9		1800	15/300kHz	0.08	110.0	2R5TPE220MFGB	2000			
	105	2.5	105		3.5	2.8	1.9		1700	21	0.08	55.0	2R5TPE220MLB	2000			
	85	2.0	105	220	3.5	2.8	1.9	B2	1600	25	0.08	55.0	2R5TPE220MAPB	2000	3	3	
	105	2.5	105		3.5	2.8	1.9		1400	35	0.08	55.0	2R5TPE220MZB	2000			
	85	2.0	105	330	3.5	2.8	1.9	B2	1400	35	0.08	55.0	2R5TPE220MAZB	2000	3	3	
	105	2.5	105		3.5	2.8	1.9		1400	30	0.08	55.0	2R5TPE220MUB	2000			
	85	2.0	105	330	3.5	2.8	1.9	B2	1400	35	0.08	82.5	2R5TPE330MAZB	2000	3	3	
	85	2.0	105		3.5	2.8	1.9		3200	9/300kHz	0.08	165.0	ETPE330MA9GB	2000			
	105	2.5	105	3.5	2.8	1.9	3200	9/300kHz	0.08	165.0	ETPE330M9GB	2000					
	4.0	NRFND 85	2.0	105	330	3.5	2.8	1.9	B2	2700	15	0.08	165.0	ETPE330MAFB	2000	3	3
		105	2.5	105	330	3.5	2.8	1.9	B2	2700	15	0.08	165.0	ETPE330MFB	2000	3	3
		105	2.5	105		3.5	2.8	1.9		2450	18	0.08	165.0	ETPE330MIB	2000		
105		4.0	105	100	3.5	2.8	1.9	B2	1400	35	0.08	40.0	4TPE100MZB	2000	3	3	
105		4.0	105		3.5	2.8	1.9		950	70	0.08	40.0	4TPE100MBB	2000			
105		4.0	105		3.5	2.8	1.9		1300	40	0.08	40.0	4TPE100MWB	2000			
85		3.2	105	150	3.5	2.8	1.9	B2	1400	35	0.08	60.0	4TPE150MAZB	2000	3	3	
85		3.2	105	3.5	2.8	1.9	1400		35	0.08	88.0	4TPE220MAZB	2000				
105		4.0	105	220	3.5	2.8	1.9	B2	1350	35	0.10	88.0	4TPE220MZB	2000	3	3	
105		4.0	105		3.5	2.8	1.9		1150	45	0.10	88.0	4TPE220MVB	2000			
105		4.0	105		3.5	2.8	1.9		950	70	0.10	88.0	4TPE220MBB	2000			
6.3	105	6.3	105	100	3.5	2.8	1.9	B2	1600	25	0.08	63.0	6TPE100MPB	2000	3	3	
	85	5.0	105		3.5	2.8	1.9		1400	35	0.08	63.0	6TPE100MAZB	2000			
	105	6.3	105		3.5	2.8	1.9		1400	35	0.08	63.0	6TPE100MZB	2000			
	105	6.3	105	100	3.5	2.8	1.9	B2	950	70	0.08	63.0	6TPE100MBB	2000	3	3	
	105	6.3	105		3.5	2.8	1.9		1300	40	0.08	63.0	6TPE100MWB	2000			
	105	6.3	105	120	3.5	2.8	1.9	B2	1200	45	0.08	63.0	6TPE100MVB	2000	3	3	
	85	5.0	105		3.5	2.8	1.9		1400	35	0.08	75.6	6TPE120MAZB	2000			
	85	5.0	105	150	3.5	2.8	1.9	B2	1600	25	0.08	94.5	6TPE150MAPB	2000	3	3	
	85	5.0	105		3.5	2.8	1.9		1400	35	0.08	94.5	6TPE150MAZB	2000			
	85	5.0	105	220	3.5	2.8	1.9	B2	1400	35	0.10	138.6	6TPE220MAZB	2000	3	3	
	85	5.0	105		3.5	2.8	1.9		1600	25	0.10	138.6	6TPE220MAPB	2000			
	105	6.3	105		3.5	2.8	1.9		1150	45	0.10	138.6	6TPE220MVB	2000			
	105	6.3	105	220	3.5	2.8	1.9	B2	950	70	0.10	138.6	6TPE220MBB	2000	3	3	
105	6.3	105	3.5		2.8	1.9	1350		35	0.10	138.6	6TPE220MZB	2000				
8.0	85	6.3	105	100	3.5	2.8	1.9	B2	1400	35	0.08	80.0	8TPE100MAZB	2000	3	3	
10	85	8.0	105	47	3.5	2.8	1.9	B2	1400	35	0.08	47.0	10TPE47MAZB	2000	3	3	

*1: Ripple current (100 kHz / +45 °C) *2: ESR (100 kHz / +20 °C) *3: tan δ (120 Hz / +20 °C) *4: After 5 minutes

◆ Please refer to each page in this catalog for "Reflow conditions", "Taping specifications" and "Floor life level".

◆ Small order quantity (500 pcs/reel) is available with TPE series. Please contact our sales representative if you prefer it.

NRFND Not recommended for new design



Some part numbers are not a recommended product.
Not recommended for new design.

Conductive Polymer Tantalum
Solid Capacitors
Surface Mount Type
TPE series D size

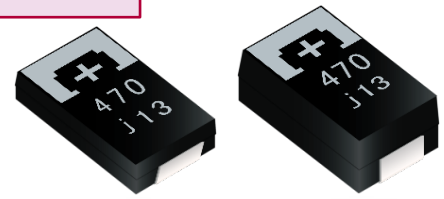

Features

- Low profile (Height 1.5 mm max.)
- Low ESR (7 mΩ max.)
- Large capacitance (1500 μF max.)
- RoHS compliance, Halogen free

Specifications

Size code	D15E	D2E	D3L	D4
Category temp. range	-55 °C to +105 °C			
Rated volt. range	6.3 V	2.5 V to 10 V		
Category volt. range	5.0 V	2.5 V to 10 V		
Rated cap. range	470 μF	68 μF to 470 μF	150 μF to 680 μF	330 μF to 1500 μF
Capacitance tolerance	±20 % (120 Hz / +20 °C)			
Leakage current	Please see the attached characteristics list			
Dissipation factor(tan δ)	Please see the attached characteristics list			
Surge voltage (V)	Rated voltage × 1.15			
Endurance	+105 °C 2000 h rated voltage applied			
	Rated temp, +85 °C Products : +85 °C 1000 h, rated voltage applied			
	(6TPE330MAP, 6TPE470MAZU : +85 °C 2000 h, rated voltage applied)			
	Capacitance change	Within ±20 % of the initial value		
Damp heat (Steady State)	Dissipation factor(tan δ)	≤ 1.5 times of the initial limit		
	Leakage current	Within the initial limit		
	Capacitance change	Within +50 %, -20 % of the initial value (2R5TPE220M (I, F, 9), 2R5TPE330M (I, F, C, 9, 7), 2R5TPE470M (I, F, C, 9, 7), 2R5TPE1000MF, 2R5TPE1500M (F, C))		
Damp heat (Steady State)	Dissipation factor(tan δ)	≤ 1.5 times of the initial limit		
	Leakage current	≤ 3 times of the initial limit		
	Capacitance change	Within +40 %, -20 % of the initial value (Except for above model)		

Marking

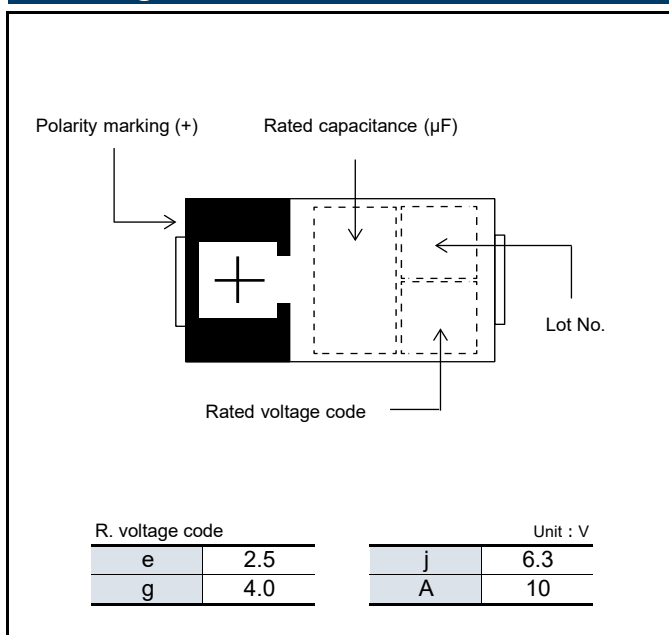

Dimensions (not to scale)

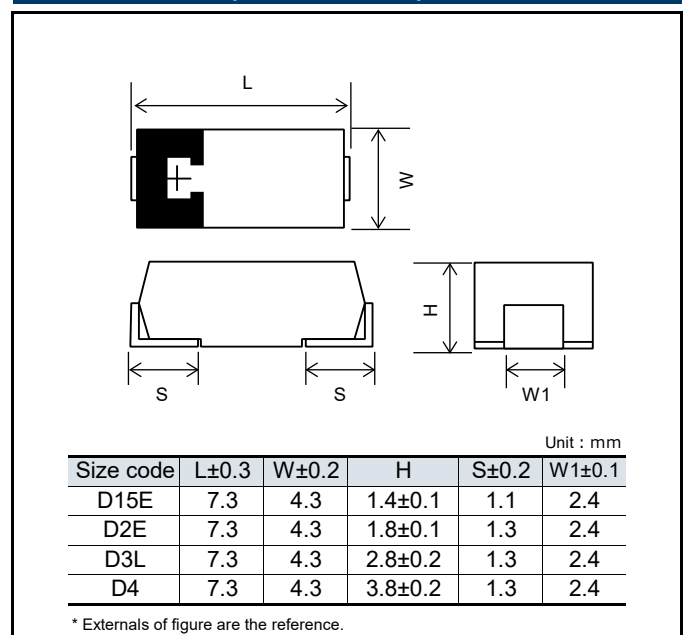

Characteristics list

Rated voltage (V)	Rated temperature (°C)	Category voltage (V)	Category temperature (°C)	Rated capacitance (µF)	Case size (mm)			Size code	Specifications				Standard		Floor life level			
					L	W	H		Ripple ^{*1} current (mA rms)	ESR ^{*2} (mΩ max.)	tan δ ^{*3}	LC ^{*4} (µA)	Part number	Min. packaging q'ty (pcs)	Reflow temp ≤260°C	Reflow temp ≤250°C		
2.5	105	2.5	105	220	7.3	4.3	1.8	D2E	3900	9	0.10	55.0	2R5TPE220M9	3000	3			
	105	2.5	105		7.3	4.3	1.8		3100	15	0.10	55.0	2R5TPE220MF	3000				
	105	2.5	105		7.3	4.3	1.8		2800	18	0.10	55.0	2R5TPE220MI	3000				
	105	2.5	105		7.3	4.3	1.8		2400	25	0.10	55.0	2R5TPE220M	3000				
	105	2.5	105	330	7.3	4.3	1.8		4400	7	0.10	82.5	2R5TPE330M7	3000				
	105	2.5	105		7.3	4.3	1.8		3900	9	0.10	82.5	2R5TPE330M9	3000				
	105	2.5	105		7.3	4.3	1.8		3500	12	0.10	82.5	2R5TPE330MC	3000				
	105	2.5	105		7.3	4.3	1.8		3100	15	0.10	82.5	2R5TPE330MF	3000				
	105	2.5	105	470	7.3	4.3	1.8		2800	18	0.10	82.5	2R5TPE330MI	3000				
	105	2.5	105		7.3	4.3	1.8		2400	25	0.10	82.5	2R5TPE330M	3000				
	105	2.5	105		7.3	4.3	1.8		4400	7	0.10	117.5	2R5TPE470M7	3000				
	105	2.5	105		7.3	4.3	1.8		3900	9	0.10	117.5	2R5TPE470M9	3000				
	105	2.5	105	680	7.3	4.3	1.8		3500	12	0.10	117.5	2R5TPE470MC	3000				
	105	2.5	105		7.3	4.3	1.8		3100	15	0.10	117.5	2R5TPE470MF	3000				
	105	2.5	105		7.3	4.3	1.8		2800	18	0.10	117.5	2R5TPE470MI	3000				
	105	2.5	105		7.3	4.3	2.8		3500	12	0.10	170.0	2R5TPE680MCL	2500				
	105	2.5	105	1000	7.3	4.3	3.8		3100	15	0.10	170.0	2R5TPE680MFL	2500				
	105	2.5	105		7.3	4.3	3.8		1850	40	0.10	170.0	2R5TPE680MWL	2500				
	105	2.5	105		7.3	4.3	3.8		3900	15	0.15	250.0	2R5TPE1000MF	2000				
	105	2.5	105		7.3	4.3	3.8		4400	12	0.15	375.0	2R5TPE1500MC	2000				
105	2.5	105	1500	7.3	4.3	3.8	3900	15	0.15	375.0	2R5TPE1500MF	2000	-	-				
4.0	105	4.0	105	150	7.3	4.3	1.8	D2E	2800	18	0.10	60.0	4TPE150MI	3000	3	2a		
	105	4.0	105	220	7.3	4.3	1.8		3100	15	0.10	88.0	4TPE220MF	3000				
	105	4.0	105		7.3	4.3	1.8		2800	18	0.10	88.0	4TPE220MI	3000				
	105	4.0	105		7.3	4.3	1.8		2400	25	0.10	88.0	4TPE220M	3000				
	105	4.0	105		7.3	4.3	1.8		1750	45	0.10	88.0	4TPE220MV	3000				
	105	4.0	105	330	7.3	4.3	1.8		2800	18	0.10	132.0	4TPE330MI	3000				
	105	4.0	105		7.3	4.3	1.8		2400	25	0.10	132.0	4TPE330M	3000				
	105	4.0	105		7.3	4.3	1.8		1850	40	0.10	132.0	4TPE330MW	3000				
	105	4.0	105		7.3	4.3	2.8		3500	12	0.10	188.0	4TPE470MCL	2500				
	105	4.0	105	470	7.3	4.3	2.8		3100	15	0.10	188.0	4TPE470MFL	2500				
	105	4.0	105		7.3	4.3	2.8		2800	18	0.10	188.0	4TPE470MIL	2500				
	105	4.0	105		7.3	4.3	2.8		2400	25	0.10	188.0	4TPE470ML	2500				
	105	4.0	105		7.3	4.3	2.8		1850	40	0.10	188.0	4TPE470MWL	2500				
	6.3	105	6.3	105	100	7.3	4.3		1.8	D2E	2800	18	0.10	63.0	6TPE100MI	3000	3	
		105	6.3	105		7.3	4.3		1.8		2400	25	0.10	63.0	6TPE100M	3000		
		105	6.3	105		7.3	4.3		1.8		1850	40	0.10	63.0	6TPE100MW	3000		
105		6.3	105	7.3		4.3	1.8	3100	15		0.10	94.5	6TPE150MF	3000				
105		6.3	105	150	7.3	4.3	1.8	2800	18		0.10	94.5	6TPE150MI	3000				
105		6.3	105		7.3	4.3	1.8	2400	25		0.10	94.5	6TPE150M	3000				
105		6.3	105		7.3	4.3	1.8	2800	18		0.10	138.6	6TPE220MI	3000				
105		6.3	105		7.3	4.3	1.8	2400	25		0.10	138.6	6TPE220M	3000				
105		6.3	105	220	7.3	4.3	1.8	2400	25		0.10	138.6	6TPE220MAP	3000				
85		5.0	105		7.3	4.3	1.8	2400	25		0.10	138.6	6TPE220MW	3000				
105		6.3	105		7.3	4.3	1.8	1850	40		0.10	138.6	6TPE220MW	3000				
105		6.3	105		7.3	4.3	2.8	D3L	2800		18	0.10	138.6	6TPE220MIL	2500	-		
85		5.0	105	330	7.3	4.3	1.8	D2E	2400		25	0.10	207.9	6TPE330MAP	3000	3		
85		5.0	105	330	7.3	4.3	2.8	D3L	2400		25	0.10	207.9	6TPE330MAL	2500	3	2a	
105		6.3	105	330	7.3	4.3	2.8	D3L	3900		9/500kHz	0.10	207.9	6TPE330MA9EL	2500	3	2a	
105		6.3	105		7.3	4.3	2.8		3100		15	0.10	207.9	6TPE330MFL	2500			
105	6.3	105	7.3		4.3	2.8	2800		18	0.10	207.9	6TPE330MIL	2500					
105	6.3	105	7.3		4.3	2.8	2400		25	0.10	207.9	6TPE330ML	2500					
85	5.0	105	470	7.3	4.3	3.8	D4	4400	10	0.10	207.9	6TPE330MAA	2000					
105	6.3	105		7.3	4.3	1.4	D15E	1700	35	0.10	296.1	6TPE470MAZU	4000					
105	6.3	105		7.3	4.3	3.8	D4	3500	18	0.15	296.1	6TPE470MI	2000					
105	6.3	105		7.3	4.3	3.8		3000	25	0.15	296.1	6TPE470M	2000					
105	6.3	105	7.3	4.3	3.8	2500		35	0.15	296.1	6TPE470MZ	2000						
105	6.3	105	7.3	4.3	3.8	2350		40	0.15	296.1	6TPE470MW	2000						
105	6.3	105	680	7.3	4.3	3.8	D4	3500	18	0.15	428.4	6TPE680MI	2000					
105	6.3	105		7.3	4.3	3.8		3000	25	0.15	428.4	6TPE680M	2000					
10	105	10	105	68	7.3	4.3	1.8	D2E	2400	25	0.10	68.0	10TPE68M	3000	3			
	105	10	105		7.3	4.3	1.8		1850	40	0.10	68.0	10TPE68MW	3000				
	105	10	105	150	7.3	4.3	2.8	D3L	2400	25	0.10	150.0	10TPE150MPL	2500				
	105	10	105		7.3	4.3	2.8		2800	18	0.10	220.0	10TPE220MIL	2500				
	105	10	105	220	7.3	4.3	2.8	D3L	2400	25	0.10	220.0	10TPE220ML	2500				
	105	10	105		7.3	4.3	2.8		2400	25	0.10	220.0	10TPE220ML	2500				
	105	10	105	330	7.3	4.3	3.8	D4	3000	25	0.10	330.0	10TPE330M	2000	-	2a		

*1: Ripple current (100 kHz / +45 °C) *2: ESR (100 kHz / +20 °C) *3: tan δ (120 Hz / +20 °C) *4: After 5 minutes

◆ Please refer to each page in this catalog for "Reflow conditions", "Taping specifications" and "Floor life level".

◆ Small order quantity (500 pcs/reel) is available with TPE series. Please contact our sales representative if you prefer it.

NRFND

Not recommended for new design

Design and specifications are each subject to change without notice. Ask factory for the current technical specifications before purchase and/or use.

Should a safety concern arise regarding this product, please be sure to contact us immediately.

Conductive Polymer Tantalum Solid Capacitors Surface Mount Type TPF series

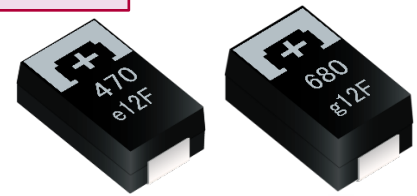

Features

- Super low ESR (5 mΩ max.)
- Large capacitance (1000 μF max.)
- RoHS compliance, Halogen free

Specifications

Size code	D2E	D3L	D4
Category temp. range	-55 °C to +105 °C		
Rated volt. range	2.0 V	2.5 V to 10 V	2.5 V to 6.3 V
Category volt. range	2.0 V	2.5 V to 10 V	2.5 V to 6.3 V
Rated cap. range	220 μF to 330 μF	150 μF to 680 μF	470 μF to 1000 μF
Capacitance tolerance	±20 % (120 Hz / +20 °C)		
Leakage current	Please see the attached characteristics list		
Dissipation factor(tan δ)	Please see the attached characteristics list		
Surge voltage (V)	Rated voltage × 1.15		
Endurance	+105 °C 2000 h rated voltage applied		
	Capacitance change	Within ±20 % of the initial value	
	Dissipation factor(tan δ)	≤ 1.5 times of the initial limit	
	Leakage current	Within the initial limit	
Damp heat (Steady State)	+60 °C, 90 % to 95 % RH, 500 h, No-applied voltage		
	Capacitance change	Within +50 %, -20 % of the initial value (2TPF220M6, 2TPF330M6, ETPF1000M6H (5H))	
		Within +40 %, -20 % of the initial value (Except for above model)	
	Dissipation factor(tan δ)	≤ 1.5 times of the initial limit	
Leakage current	≤ 3 times of the initial limit		

Marking

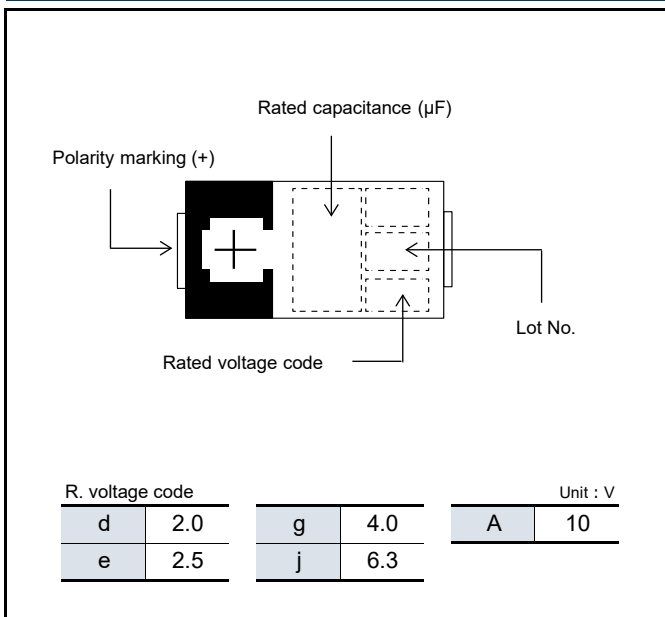

Dimensions (not to scale)

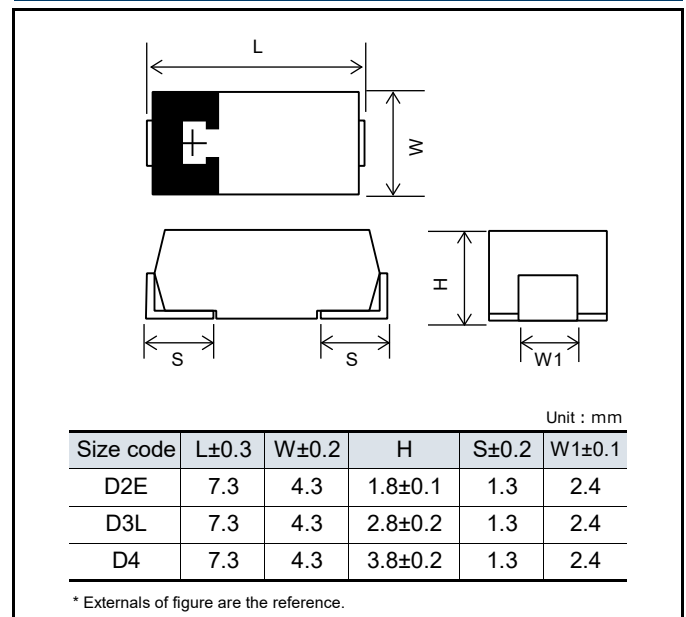

Characteristics list

Rated voltage (V)	Rated temperature (°C)	Category voltage (V)	Category temperature (°C)	Rated capacitance (µF)	Case size (mm)			Size code	Specifications				Standard		Floor life level		
					L	W	H		Ripple current ^{*1} (mA rms)	ESR ^{*2} (mΩ max.)	tan δ ^{*3}	LC ^{*4} (µA)	Part number	Min. packaging qty (pcs)	Reflow temp ≤260°C	Reflow temp ≤250°C	
2.0	105	2.0	105	220	7.3	4.3	1.8	D2E	4700	6	0.10	88.0	2TPF220M6	3000	-		
	105	2.0	105	330	7.3	4.3	1.8		4700	6	0.10	132.0	2TPF330M6	3000			
2.5	105	2.5	105	330	7.3	4.3	2.8	D3L	4400	7	0.10	82.5	2R5TPF330M7L	2500	3		
	105	2.5	105		7.3	4.3	2.8		4400	6	0.10	117.5	2R5TPF470M6L	2500			
	105	2.5	105		7.3	4.3	2.8		4400	7	0.10	117.5	2R5TPF470M7L	2500			
	105	2.5	105		7.3	4.3	2.8		4400	10	0.10	117.5	2R5TPF470ML	2500			
	105	2.5	105	470	7.3	4.3	3.8	D4	6100	5	0.10	117.5	ETPF470M5H	2000			
	105	2.5	105		7.3	4.3	2.8		D3L	3850	9	0.10	117.5	2R5TPF470M9L			2500
	105	2.5	105		7.3	4.3	2.8	4400		6	0.10	170.0	2R5TPF680M6L	2500			
	105	2.5	105		7.3	4.3	2.8	4400		7	0.10	170.0	2R5TPF680M7L	2500			
	105	2.5	105		7.3	4.3	2.8	4400		10	0.10	170.0	2R5TPF680ML	2500			
	105	2.5	105		680	7.3	4.3	3.8	D4	6100	5	0.10	170.0	ETPF680M5H			2000
	105	2.5	105	7.3		4.3	3.8	D3L		2700	25	0.10	170.0	ETPF680MPH			2000
	105	2.5	105	7.3		4.3	2.8		6100	5	0.10	250.0	ETPF1000M5H	2000			
	105	2.5	105	7.3		4.3	2.8		5600	6	0.10	250.0	ETPF1000M6H	2000			
	105	2.5	105	1000	7.3	4.3	3.8		D4	6100	5	0.10	250.0	ETPF1000M5H			2000
105	2.5	105	7.3		4.3	3.8	D3L	3900		9	0.10	132.0	4TPF330M9L	2500			
105	4.0	105	7.3		4.3	2.8		4000	12	0.10	132.0	4TPF330ML	2500				
105	4.0	105	7.3		4.3	2.8		3550	15	0.10	132.0	4TPF330MFL	2500				
105	4.0	105	7.3	4.3	2.8	4400		10	0.10	188.0	4TPF470ML	2500					
4.0	105	4.0	105	330	7.3	4.3	3.8	D4	4400	10	0.10	272.0	4TPF680MAH	2000	2a		
	105	4.0	105		7.3	4.3	3.8		D3L	3550	15	0.10	272.0	4TPF680MFH			2000
	105	4.0	105		7.3	4.3	3.8			2350	35	0.10	272.0	4TPF680MZH			2000
	105	4.0	105	7.3	4.3	2.8	D3L	4400		10	0.10	272.0	4TPF680MAH	2000			
	105	4.0	105	7.3	4.3	2.8		3550	15	0.10	272.0	4TPF680MFH	2000				
	105	4.0	105	7.3	4.3	2.8		2350	35	0.10	272.0	4TPF680MZH	2000				
6.3	105	6.3	105	150	7.3	4.3	2.8	D3L	2750	25	0.10	94.5	6TPF150MPL	2500	3	-	
	105	6.3	105		7.3	4.3	2.8		6100	5	0.10	138.6	6TPF220M5L	2500			
	105	6.3	105		7.3	4.3	2.8		5550	6	0.10	138.6	6TPF220M6L	2500			
	105	6.3	105		7.3	4.3	2.8		4600	9	0.10	138.6	6TPF220M9L	2500			
	105	6.3	105	220	7.3	4.3	2.8	D3L	4000	12	0.10	138.6	6TPF220ML	2500			
	105	6.3	105		7.3	4.3	2.8		3550	15	0.10	138.6	6TPF220MFL	2500			
	105	6.3	105		7.3	4.3	2.8		2750	25	0.10	138.6	6TPF220MPL	2500			
	105	6.3	105	330	7.3	4.3	2.8	D3L	3900	9	0.10	207.9	6TPF330M9L	2500			
	105	6.3	105		7.3	4.3	2.8		3650	10	0.10	207.9	6TPF330MAL	2500			
	105	6.3	105		7.3	4.3	3.8		D4	4400	10	0.10	296.1	6TPF470MAH			2000
	105	6.3	105		7.3	4.3	3.8			3550	15	0.10	296.1	6TPF470MFH			2000
10	105	10	105	150	7.3	4.3	2.8	D3L	3600	15	0.10	150.0	10TPF150ML	2500	-		

*1: Ripple current (100 kHz / +45 °C)

*2: ESR (100 kHz / +20 °C)

*3: tan δ (120 Hz / +20 °C)

*4: After 5 minutes

◆ Please refer to each page in this catalog for "Reflow conditions", "Taping specifications" and "Floor life level".

◆ Small order quantity (500 pcs/reel) is available with TPF series. Please contact our sales representative if you prefer it.

NRFND Not recommended for new design

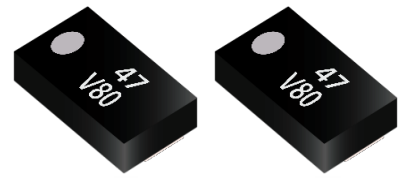

Conductive Polymer Tantalum Solid Capacitors

Surface Mount Type

TQS series

Features

- High voltage (35 V max.)
- RoHS compliance, Halogen free

Specifications

Size code	D15S	
Category temp. range	-55 °C to +105 °C	
Rated volt. range	35 V	
Category volt. range	35 V	
Rated cap. range	47 μF	
Capacitance tolerance	±20 % (120 Hz / +20 °C)	
Leakage current	Please see the attached characteristics list	
Dissipation factor(tan δ)	Please see the attached characteristics list	
Surge voltage (V)	Rated voltage × 1.15	
Endurance	+105 °C 2000 h rated voltage applied	
	Capacitance change	Within ±20 % of the initial value
	Dissipation factor(tan δ)	≤ 1.5 times of the initial limit
	Leakage current	Within the initial limit
Damp heat (Steady State)	+60 °C, 90 % to 95 % RH, 500 h, No-applied voltage	
	Capacitance change	Within +40 %, -20 % of the initial value
	Dissipation factor(tan δ)	≤ 1.5 times of the initial limit
	Leakage current	≤ 3 times of the initial limit

Marking

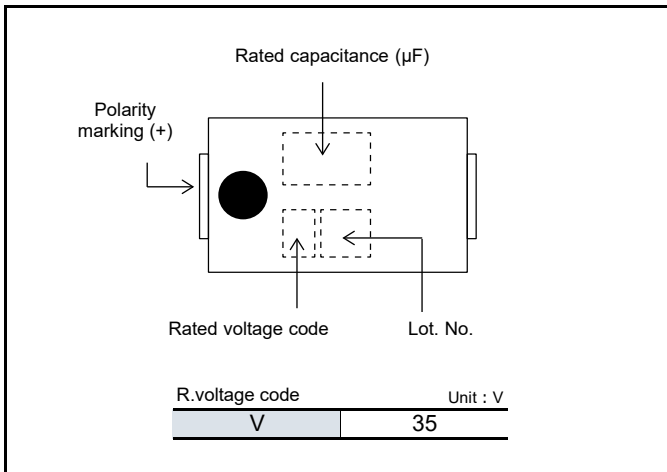

Dimensions (not to scale)

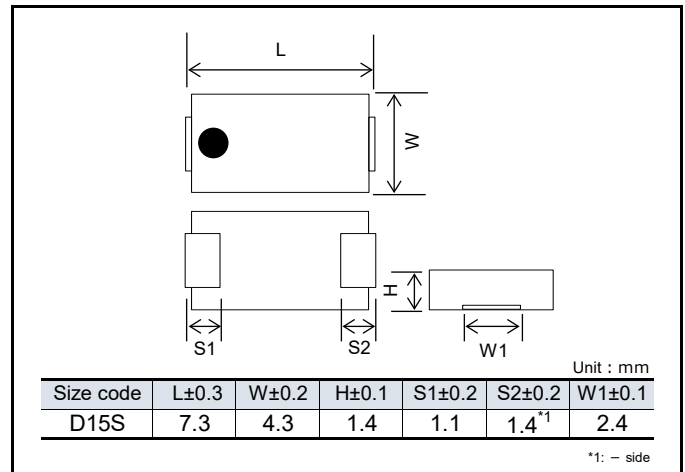

Characteristics list

Rated voltage (V)	Rated temperature (°C)	Category voltage (V)	Category temperature (°C)	Rated capacitance (μF)	Case size (mm)			Size code	Specifications				Standard		Floor life level	
					L	W	H		Ripple current ^{*1} (mA rms)	ESR ^{*2} (mΩ max.)	tan δ ^{*3}	LC ^{*4} (μA)	Part number	Min. packaging q'ty (pcs)	Reflow temp ≤260°C	Reflow temp ≤250°C
35	105	35	105	47	7.3	4.3	1.4	D15S	1200	100	0.10	164.5	35TQS47MEU	4000	3	3

*1: Ripple current (100 kHz / +105 °C)

*2: ESR (100 kHz / +20 °C)

*3: tan δ (120 Hz / +20 °C)

*4: After 5 minutes

◆ Please refer to each page in this catalog for "Reflow conditions", "Taping specifications" and "Floor life level".

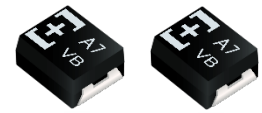

Conductive Polymer Tantalum Solid Capacitors

Surface Mount Type
TQC series **B** size

Features

- High voltage (35 V max.)
- RoHS compliance, Halogen free

Specifications

Size code	B2	
Category temp. range	-55 °C to +105 °C	
Rated volt. range	16 V to 35 V	
Category volt. range	16 V to 35 V	
Rated cap. range	3.9 μF to 47 μF	
Capacitance tolerance	±20 % (120 Hz / +20 °C)	
Leakage current	Please see the attached characteristics list	
Dissipation factor(tan δ)	Please see the attached characteristics list	
Surge voltage (V)	Rated voltage × 1.15	
Endurance	+105 °C 2000 h (16TQC33MYFB : 1000 h), rated voltage applied	
	Capacitance change	Within ±20 % of the initial value
	Dissipation factor(tan δ)	≤ 1.5 times of the initial limit
	Leakage current	Within the initial limit
Damp heat (Steady State)	+60 °C, 90 % to 95 % RH, 500 h, No-applied voltage	
	Capacitance change	Within +40 %, -20 % of the initial value
	Dissipation factor(tan δ)	≤ 1.5 times of the initial limit
	Leakage current	≤ 3 times of the initial limit

Marking

Polarity marking (+) Rated capacitance code

Rated voltage code Lot. No.

Code	Value (V)
C	16
D	20
E	25
V	35

Unit : V

Code	Value (μF)
Q6	3.9
U6	5.6
Y6	8.2
A7	10
E7	15
J7	22
N7	33
S7	47

Unit : μF

Dimensions (not to scale)

Size code	L±0.2	W±0.2	H±0.1	S±0.2	W1±0.1
B2	3.5	2.8	1.9	0.8	2.2

Unit : mm

* Externals of figure are the reference.

Characteristics list

Rated voltage (V)	Rated temperature (°C)	Category voltage (V)	Category temperature (°C)	Rated capacitance (μF)	Case size (mm)			Size code	Specifications				Standard		Floor life level		
					L	W	H		Ripple current (mA rms)	ESR ^{*2} (mΩ max.)	tan δ ^{*3}	LC ^{*4} (μA)	Part number	Min. packaging q'ty (pcs)	Reflow temp ≤260°C	Reflow temp ≤250°C	
16	105	16	105	10	3.5	2.8	1.9	B2	800	100	0.10	48.0	16TQC10M	2000	-	3	
	105	16	105	15	3.5	2.8	1.9		1000	90	0.10	72.0	16TQC15M	2000			
	105	16	105	22	3.5	2.8	1.9		1000	90	0.10	35.2	16TQC22MYFB	2000			
	105	16	105	33	3.5	2.8	1.9		1000	90	0.10	158.4	16TQC33MYFB	2000			
	105	16	105	47	3.5	2.8	1.9		1000	90	0.15	225.6	16TQC47MYFB	2000	3		
20	105	20	105	8.2	3.5	2.8	1.9		800	100	0.10	49.2	20TQC8R2M	2000	-		
	105	20	105	22	3.5	2.8	1.9		1100	90	0.10	132.0	20TQC22MYFB	2000			
25	105	25	105	5.6	3.5	2.8	1.9		800	100	0.10	42.0	25TQC5R6M	2000			
	105	25	105	10	3.5	2.8	1.9		900	100	0.10	25.0	25TQC10MEB	2000			
	105	25	105	15	3.5	2.8	1.9		900	100	0.10	112.5	25TQC15MYFB	2000			
	105	25	105	22	3.5	2.8	1.9		1100	100	0.10	165.0	25TQC22MYFB	2000			3
35	105	35	105	3.9	3.5	2.8	1.9		500	400	0.10	40.9	35TQC3R9MYF	2000			-
	105	35	105	10	3.5	2.8	1.9		900	150	0.15	105.0	35TQC10MYFB	2000			3
	105	35	105		3.5	2.8	1.9		750	200	0.15	105.5	35TQC10MXB	2000			3

*1: Ripple current (100 kHz / +105 °C)

*2: ESR (100 kHz / +20 °C)

*3: tan δ (120 Hz / +20 °C)

*4: After 5 minutes

◆ Please refer to each page in this catalog for "Reflow conditions", "Taping specifications" and "Floor life level".

◆ Small order quantity (500 pcs/reel) is available with TQC series. Please contact our sales representative if you prefer it.



Conductive Polymer Tantalum Solid Capacitors

Surface Mount Type

TQC series D size

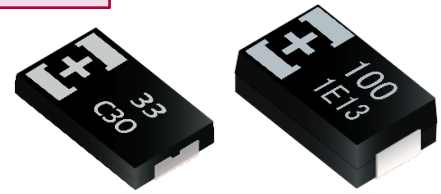

Features

- High voltage (35 V max.)
- RoHS compliance, Halogen free

Specifications

Size code	D12	D15	D2	D3L
Category temp. range	-55 °C to +105 °C			
Rated volt. range	16 V	16 V to 25 V	16 V to 35 V	16 V to 25 V
Category volt. range	16 V	16 V to 25 V	16 V to 35 V	16 V to 25 V
Rated cap. range	33 μF	22 μF to 47 μF	10 μF to 150 μF	68 μF to 220 μF
Capacitance tolerance	±20 % (120 Hz / +20 °C)			
Leakage current	Please see the attached characteristics list			
Dissipation factor(tan δ)	Please see the attached characteristics list			
Surge voltage (V)	Rated voltage × 1.15			
Endurance	+105 °C 2000 h rated voltage applied			
	Capacitance change	Within ±20 % of the initial value		
	Dissipation factor(tan δ)	≤ 1.5 times of the initial limit		
	Leakage current	Within the initial limit		
Damp heat (Steady State)	+60 °C, 90 % to 95 % RH, 500 h, No-applied voltage			
	Capacitance change	Within +40 %, -20 % of the initial value		
	Dissipation factor(tan δ)	≤ 1.5 times of the initial limit		
	Leakage current	≤ 3 times of the initial limit		

Marking

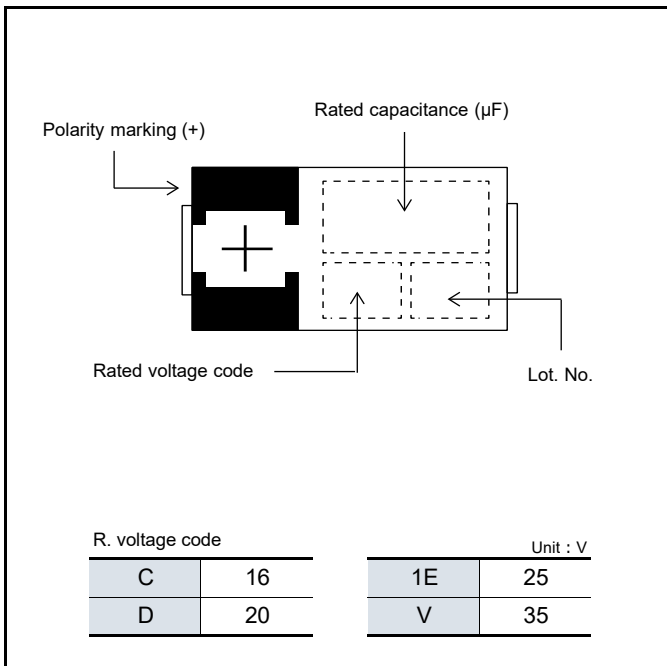

Dimensions (not to scale)

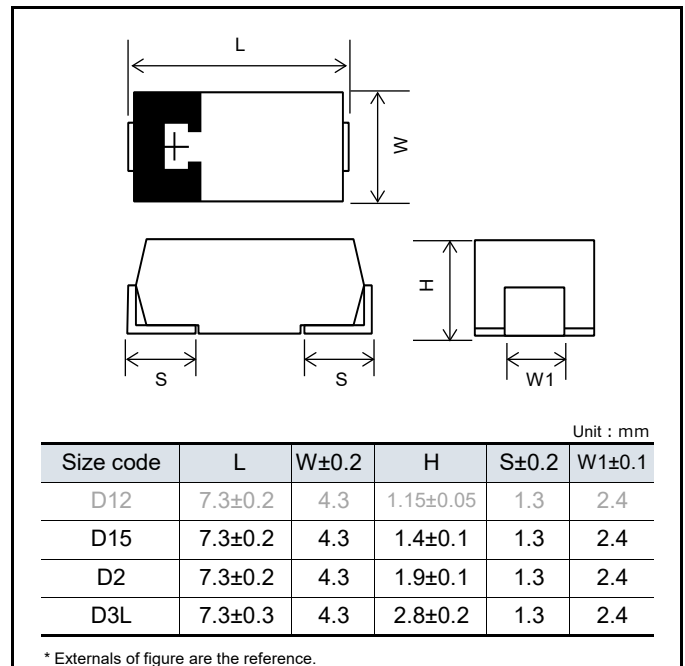

Characteristics list

Rated voltage (V)	Rated temperature (°C)	Category voltage (V)	Category temperature (°C)	Rated capacitance (µF)	Case size (mm)			Size code	Specifications				Standard		Floor life level	
					L	W	H		Ripple ^{*1} current (mA rms)	ESR ^{*2} (mΩ max.)	tan δ ^{*3}	LC ^{*4} (µA)	Part number	Min. packaging q'ty (pcs)	Reflow temp ≤260°C	Reflow temp ≤250°C
16	NRFND 105	16	105	33	7.3	4.3	1.15	D12	1800	40	0.10	52.8	16TQC33MYFS	4500	-	3
	105	16	105		7.3	4.3	1.9	D2	1400	70	0.10	52.8	16TQC33MYFD	3000		
	105	16	105	47	7.3	4.3	1.4	D15	1500	55	0.10	75.2	16TQC47MYFT	3000		
	105	16	105		7.3	4.3	1.9	D2	1800	40	0.10	75.2	16TQC47MW	3000		
	105	16	105		7.3	4.3	1.9		1450	55	0.10	75.2	16TQC47MYFD	3000		
	105	16	105		7.3	4.3	1.9		1250	70	0.10	75.2	16TQC47MBD	3000		
	105	16	105		68	7.3	4.3		1.9	1500	50	0.10	108.8	16TQC68MYF		
	105	16	105	100	7.3	4.3	1.9		1800	50	0.10	160.0	16TQC100MYF	3000		
	105	16	105	150	7.3	4.3	2.8	D3L	1800	50	0.10	240.0	16TQC150MYF	2500		
	105	16	105	150	7.3	4.3	1.9	D2	1500	70	0.15	240.0	1CTQC15173F1	3000		
	105	16	105	220	7.3	4.3	2.8	D3L	1750	50	0.10	352.0	16TQC220MD3	2500		
20	105	20	105	22	7.3	4.3	1.9	D2	1200	90	0.10	44.0	20TQC22MQD	3000		
	105	20	105	33	7.3	4.3	1.9		1400	60	0.10	66.0	20TQC33MYFD	3000		
	105	20	105	47	7.3	4.3	1.9		1450	55	0.10	94.0	20TQC47MYF	3000		
	105	20	105		7.3	4.3	1.4	D15	1500	55	0.10	94.0	20TQC47MYFT	3000		
	105	20	105	100	7.3	4.3	1.9	D2	1250	100	0.15	200.0	20TQC100MD2	3000		
	105	20	105		7.3	4.3	2.8	D3L	1700	55	0.10	200.0	20TQC100MYF	2500		
25	105	25	105	15	7.3	4.3	1.9	D2	1500	45	0.10	38.0	25TQC15MV	3000		
	105	25	105		7.3	4.3	1.9		1000	90	0.10	38.0	25TQC15MYFD	3000		
	105	25	105	22	7.3	4.3	1.9		1500	45	0.10	55.0	25TQC22MV	3000		
	105	25	105		7.3	4.3	1.9		1400	60	0.10	55.0	25TQC22MYFD	3000		
	105	25	105	33	7.3	4.3	1.4	D15	1400	70	0.10	55.0	25TQC22MYFT	3000		
	105	25	105		7.3	4.3	1.9	D2	1400	60	0.10	82.5	25TQC33MYF	3000		
	105	25	105	68	7.3	4.3	2.8	D3L	1400	70	0.10	170.0	25TQC68MYF	2500		
	105	25	105	100	7.3	4.3	2.8		1600	60	0.10	250.0	25TQC100MD3	2500		
35	NRFND 105	35	105	10	7.3	4.3	1.9	D2	1000	120	0.10	35.0	35TQC10M	3000		
	105	35	105		7.3	4.3	1.9		1000	120	0.10	35.0	35TQC10MYF	3000		
	105	35	105	15	7.3	4.3	1.9		900	150	0.10	52.5	35TQC15MYF	3000		

*1: Ripple current (100 kHz / +105 °C)

*2: ESR (100 kHz / +20 °C)

*3: tan δ (120 Hz / +20 °C)

*4: After 5 minutes

◆ Please refer to each page in this catalog for "Reflow conditions", "Taping specifications" and "Floor life level".

◆ Small order quantity (500 pcs/reel) is available with TQC series. Please contact our sales representative if you prefer it.

NRFND

Not recommended for new design

Conductive Polymer Tantalum Solid Capacitors Surface Mount Type TA series

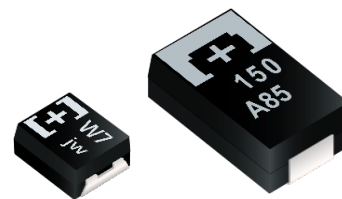

■ This product is not intended for use in any driving application or any other critical functions that affect passenger safety (e.g. Powertrain, ABS, Engine ECU, Airbag, etc.)
If the intended use of TA/TV series products is for use in other automotive related applications, please contact our sales team. All requests are subject to approval.

Features

- Guaranteed at 85 °C 85 %RH
- RoHS compliance, Halogen free

Specifications

Size code	B2	D2E	D3L
Category temp. range	-55 °C to +105 °C		
Rated volt. range	4.0 V to 10 V	2.5 V to 10 V	
Category volt. range	4.0 V to 10 V	2.5 V to 10 V	
Rated cap. range	47 μF to 100 μF	68 μF to 470 μF	150 μF to 680 μF
Capacitance tolerance	±20 % (120 Hz / +20 °C)		
Leakage current	Please see the attached characteristics list		
Dissipation factor(tan δ)	Please see the attached characteristics list		
Surge voltage (V)	Rated voltage × 1.15		
Endurance	+105 °C 2000 h (B2 size : 1000 h) , rated voltage applied		
	Capacitance change	Within ±20 % of the initial value	
	Dissipation factor(tan δ)	≤ 1.5 times of the initial limit	
	Leakage current	Within the initial limit	
Damp heat (Steady State)	+85 °C, 85 % to 90 % RH, 500 h, rated voltage applied		
	Capacitance change	Within +50 %, -20 % of the initial value (2R5TAE470M (F), 2R5TAE330M (I, F), 2R5TAE220M (F, 9))	
	Dissipation factor(tan δ)	≤ 1.5 times of the initial limit	
	Leakage current	Within the initial limit	

Marking

< B2 size >

< D2E, D3L size >

e	2.5
g	4

j	6.3
A	10

< B2 size >

S7	47
W7	68
A8	100

Dimensions (not to scale)

Size code	L	W±0.2	H	S±0.2	W1±0.1
B2	3.5±0.2	2.8	1.9±0.1	0.8	2.2
D2E	7.3±0.3	4.3	1.8±0.1	1.3	2.4
D3L	7.3±0.3	4.3	2.8±0.2	1.3	2.4

* Externals of figure are the reference.

Characteristics list

Rated voltage (V)	Rated temperature (°C)	Category voltage (V)	Category temperature (°C)	Rated capacitance (µF)	Case size (mm)			Size code	Specifications				Standard		Floor life level		
					L	W	H		Ripple ^{*1} current (mA rms)	ESR ^{*2} (mΩ max.)	tan δ ^{*3}	LC ^{*4} (µA)	Part number	Min. packaging qty (pcs)	Reflow temp ≤260°C	Reflow temp ≤250°C	
2.5	105	2.5	105	220	7.3	4.3	1.8	D2E	3900	9	0.10	110.0	2R5TAE220M9	3000	3	3	
	105	2.5	105		7.3	4.3	1.8		3100	15	0.10	55.0	2R5TAE220MF	3000			
	105	2.5	105		7.3	4.3	1.8		2400	25	0.10	55.0	2R5TAE220M	3000			
	105	2.5	105	330	7.3	4.3	1.8		3100	15	0.10	82.5	2R5TAE330MF	3000			
	105	2.5	105		7.3	4.3	1.8		2800	18	0.10	82.5	2R5TAE330MI	3000			
	105	2.5	105		7.3	4.3	1.8		2400	25	0.10	82.5	2R5TAE330M	3000			
	105	2.5	105	470	7.3	4.3	1.8		3100	15	0.10	117.5	2R5TAE470MF	3000			
	105	2.5	105		7.3	4.3	1.8		2400	25	0.10	117.5	2R5TAE470M	3000			
	105	2.5	105	680	7.3	4.3	2.8		D3L	3100	15	0.10	170.0	2R5TAE680MFL			2500
	105	2.5	105		7.3	4.3	2.8			2400	25	0.10	170.0	2R5TAE680ML			2500
4.0	105	4.0	105	100	3.8	2.8	1.9	B2	1100	70	0.08	40.0	4TAB100M	2000	3	3	
	105	4.0	105	220	7.3	4.3	1.8	D2E	2800	18	0.10	88.0	4TAE220MI	3000			
	105	4.0	105		7.3	4.3	1.8		2400	25	0.10	88.0	4TAE220M	3000			
	105	4.0	105	470	7.3	4.3	2.8	D3L	2800	18	0.10	188.0	4TAE470MIL	2500			
	105	4.0	105		7.3	4.3	2.8		2400	25	0.10	188.0	4TAE470ML	2500			
6.3	105	6.3	105	47	3.5	2.8	1.9	B2	1100	70	0.08	29.6	6TAB47M	2000	3	3	
	105	6.3	105	68	3.5	2.8	1.9		1100	70	0.08	42.8	6TAB68M	2000			
	105	6.3	105	150	7.3	4.3	1.8	D2E	2400	25	0.10	94.5	6TAE150M	3000			
	105	6.3	105	220	7.3	4.3	1.8		2800	18	0.10	138.6	6TAE220MI	3000			
	105	6.3	105		7.3	4.3	1.8		2400	25	0.10	138.6	6TAE220M	3000			
	105	6.3	105	330	7.3	4.3	2.8		D3L	2400	25	0.10	207.9	6TAE330ML			2500
10	105	10	105	47	3.5	2.8	1.9	B2	1100	70	0.08	47.0	10TAB47M	2000	3	3	
	105	10	105	68	7.3	4.3	1.8	D2E	2400	25	0.10	68.0	10TAE68M	3000			
	105	10	105	150	7.3	4.3	2.8	D3L	2400	25	0.10	150.0	10TAE150ML	2500			
	105	10	105	220	7.3	4.3	2.8		2400	25	0.10	220.0	10TAE220ML	2500			

*1: Ripple current (100 kHz / +45 °C)

*2: ESR (100 kHz / +20 °C)

*3: tan δ (120 Hz / +20 °C)

*4: After 5 minutes

◆ Please refer to each page in this catalog for "Reflow conditions", "Taping specifications" and "Floor life level".

Conductive Polymer Tantalum Solid Capacitors Surface Mount Type TV series

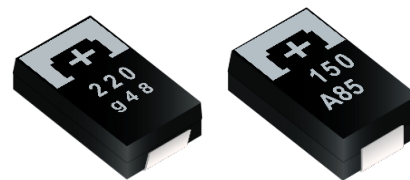

■ This product is not intended for use in any driving application or any other critical functions that affect passenger safety (e.g. Powertrain, ABS, Engine ECU, Airbag, etc.)
If the intended use of TA/TV series products is for use in other automotive related applications, please contact our sales team. All requests are subject to approval.

Features

- Guaranteed at 85 °C 85 %RH
- Guaranteed at 125 °C
- RoHS compliance, Halogen free

Specifications

Size code	D2E	D3L
Category temp. range	-55 °C to +125 °C	
Rated volt. range	6.3 V to 10 V	10 V
Category volt. range	4.0 V to 6.3 V	6.3 V
Rated cap. range	68 µF to 150 µF	150 µF
Capacitance tolerance	±20 % (120 Hz / +20 °C)	
Leakage current	Please see the attached characteristics list	
Dissipation factor(tan δ)	Please see the attached characteristics list	
Surge voltage (V)	Rated voltage × 1.15	
Endurance	+125 °C 1000 h, category voltage applied (+105 °C 2000 h, rated voltage applied)	
	Temperature	125 °C
	Capacitance change	Within ±20% of the initial value
	Dissipation factor(tan δ)	≤ 2 times of the initial limit
	Leakage current	≤ 2 times of the initial limit
Damp heat (Steady State)	+85 °C, 85 % to 90 % RH, 500 h, rated voltage applied	
	Capacitance change	Within +40 %, -20 % of the initial value
	Dissipation factor(tan δ)	≤ 1.5 times of the initial limit
	Leakage current	Within the initial limit

Marking

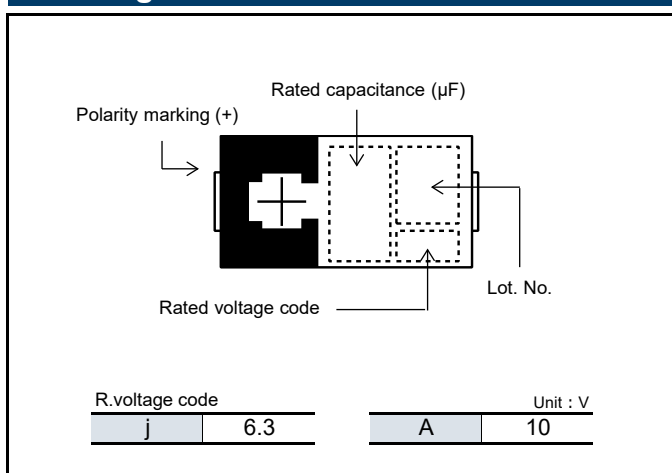

Dimensions (not to scale)

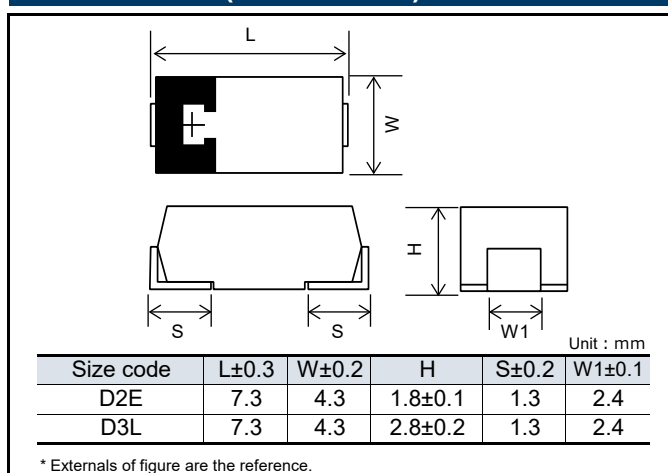

Characteristics list

Rated voltage (V)	Rated temperature (°C)	Category voltage (V)	Category temperature (°C)	Rated capacitance (µF)	Case size (mm)			Size code	Specifications				Standard		Floor life level															
					L	W	H		Ripple current ^{*1} (mA rms)	ESR ^{*2} (mΩ max.)	tan δ ^{*3}	LC ^{*4} (µA)	Part number	Min. packaging q'ty (pcs)	Reflow temp ≤200°C	Reflow temp ≤250°C														
6.3	105	4.0	125	150	7.3	4.3	1.8	D2E	2400	25	0.10	94.5	6TVE150M	3000	5	3														
																	10	105	6.3	125	68	7.3	4.3	1.8	2400	25	0.10	68.0	10TVE68M	3000

*1: Ripple current (100 kHz / +45 °C) *2: ESR (100 kHz / +20 °C) *3: tan δ (120 Hz / +20 °C) *4: After 5 minutes

◆ Please refer to each page in this catalog for "Reflow conditions", "Taping specifications" and "Floor life level".

Conductive Polymer Tantalum Solid Capacitors Surface Mount Type TH series

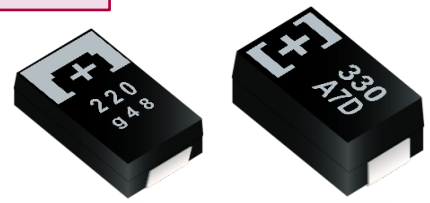

Features

- Guaranteed at 125 °C 1000 h
- RoHS compliance, Halogen free

Specifications

Size code	D2E	D2	D3L	D4
Category temp. range	-55 °C to +125 °C			
Rated volt. range	2.5 V to 6.3 V	2.5 V to 10 V	4.0 V to 6.3 V	6.3 V to 10 V
Category volt. range	1.6 V to 4.0 V	1.6 V to 6.3 V	2.5 V to 4.0 V	4.0 V to 6.3 V
Rated cap. range	150 µF to 330 µF	68 µF to 220 µF	220 µF to 330 µF	220 µF to 470 µF
Capacitance tolerance	±20 % (120 Hz / +20 °C)			
Leakage current	Please see the attached characteristics list			
Dissipation factor(tan δ)	Please see the attached characteristics list			
Surge voltage (V)	Rated voltage × 1.15			
Endurance	+125 °C 1000 h, category voltage applied			
	Capacitance change	Within ±20 % of the initial value		
	Dissipation factor(tan δ)	≤ 2 times of the initial limit		
	Leakage current	≤ 2 times of the initial limit		
Damp heat (Steady State)	+60 °C, 90 % to 95 % RH, 500 h, No-applied voltage			
	Capacitance change	Within +40 %, -20 % of the initial value		
	Dissipation factor(tan δ)	≤ 1.5 times of the initial limit		
	Leakage current	≤ 3 times of the initial limit		

Marking

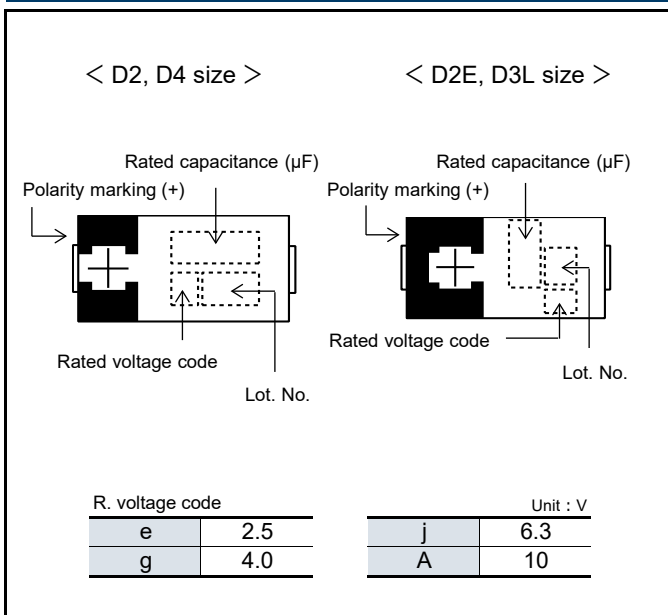

Dimensions (not to scale)

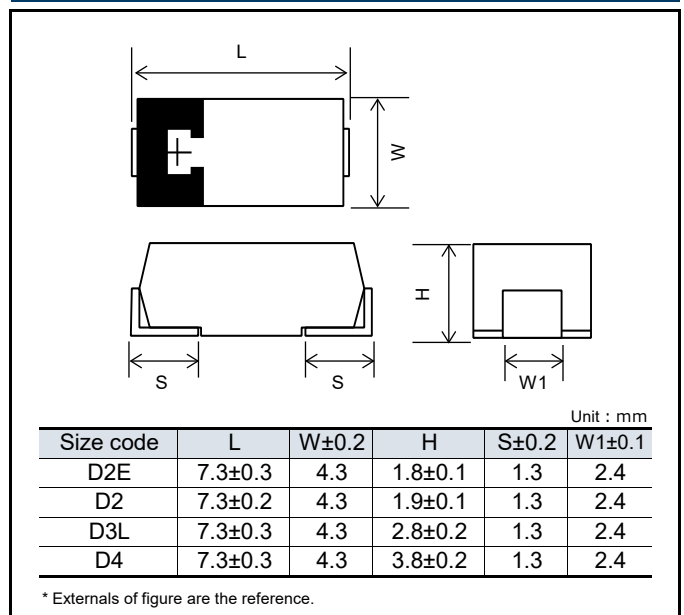

Characteristics list

Series	Rated voltage (V)	Rated temperature (°C)	Category voltage (V)	Category temp. (°C)	Rated capacitance (µF)	Case size (mm)			Size code	Specifications				Standard		Floor life level	
						L	W	H		Ripple ^{*1} current (mA rms)	ESR ^{*2} (mΩ max.)	tan δ ^{*3}	LC ^{*4} (µA)	Part number	Min. packaging q'ty (pcs)	Reflow temp ≤260°C	Reflow temp ≤250°C
THB	4.0	105	2.5	125	330	7.3	4.3	2.8	D3L	2000	40	0.10	132.0	4THB330ML	2500	-	5
	6.3	105	4.0	125	220	7.3	4.3	2.8		2000	40	0.10	138.6	6THB220ML	2500		
		10	105	4.0	125	330	7.3	4.3	3.8	D4	3000	40	0.10	207.9	6THB330M		
	105		4.0	125	470	7.3	4.3	3.8	3000		35	0.10	296.1	6THB470M	2000		
	6.3	105	6.3	125	220	7.3	4.3	3.8	3000		40	0.10	220.0	10THB220M	2000		
		105	6.3	125	330	7.3	4.3	3.8	3000		35	0.10	330.0	10THB330M	2000		
THC <small>NRFND</small>	2.5	105	1.6	125	220	7.3	4.3	1.9	D2	1700	45	0.10	55.0	2R5THC220M	3000		
	6.3	105	4.0	125	150	7.3	4.3	1.9		1900	40	0.10	94.5	6THC150M	3000		
		10	105	6.3	125	68	7.3	4.3		1.9	1700	45	0.10	68.0	10THC68M	3000	
THE	2.5	105	1.6	125	330	7.3	4.3	1.8	D2E	3100	15	0.10	82.5	2R5THE330MF	3000		
			1.6	125		7.3	4.3	1.8		2800	18	0.10	82.5	2R5THE330MI	3000		
		4.0	105	1.6		125	7.3	4.3		1.8	2400	25	0.10	82.5	2R5THE330M	3000	
			105	2.5		125	7.3	4.3		1.8	3100	15	0.10	88.0	4THE220MF	3000	
	6.3	105	2.5	125	220	7.3	4.3	1.8		2800	18	0.10	88.0	4THE220MI	3000		
			2.5	125		7.3	4.3	1.8		2400	25	0.10	88.0	4THE220M	3000		
	105	4.0	4.0	125	150	7.3	4.3	1.8		2800	18	0.10	94.5	6THE150MI	3000		
			4.0	125		7.3	4.3	1.8		2400	25	0.10	94.5	6THE150M	3000		

*1: Ripple current (100 kHz / +45 °C)

*2: ESR (100 kHz / +20 °C)

*3: tan δ (120 Hz / +20 °C)

*4: After 5 minutes

◆ Please refer to each page in this catalog for "Reflow conditions", "Taping specifications" and "Floor life level".

NRFND

Not recommended for new design

**Conductive Polymer Tantalum
Solid Capacitors**
Surface Mount Type
TPB series

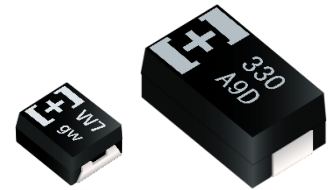

Features

- Standard
- RoHS compliance, Halogen free

Specifications

Size code	B2	D3L	D4
Category temp. range	-55 °C to +105 °C		
Rated volt. range	4.0 V to 10 V		6.3 V to 10 V
Category volt. range	4.0 V to 10 V		6.3 V to 10 V
Rated cap. range	33 µF to 68 µF	150 µF to 330 µF	220 µF to 470 µF
Capacitance tolerance	±20 % (120 Hz / +20 °C)		
Leakage current	Please see the attached characteristics list		
Dissipation factor(tan δ)	Please see the attached characteristics list		
Surge voltage (V)	Rated voltage × 1.15		
Endurance	+105 °C 2000 h, (B2 size : 1000 h) rated voltage applied Rated temp. +85 °C 1000 h rated voltage applied		
	Capacitance change	Within ±20 % of the initial value	
	Dissipation factor(tan δ)	≤ 1.5 times of the initial limit	
	Leakage current	Within the initial limit	
Damp heat (Steady State)	+60 °C, 90 % to 95 % RH, 500 h, No-applied voltage		
	Capacitance change	Within +40 %, -20 % of the initial value (Except for above model)	
	Dissipation factor(tan δ)	≤ 1.5 times of the initial limit	
	Leakage current	≤ 3 times of the initial limit	

Marking

< B2 size >

< D3L size >

< D4 size >

R. voltage code				Unit : V	
g	4.0	j	6.3	A	10

< B2 size >				Unit : µF	
N7	33	S7	47	W7	68

Dimensions (not to scale)

Size code	L	W±0.2	H	S±0.2	W1±0.1
B2	3.5±0.2	2.8	1.9±0.1	0.8	2.2
D3L	7.3±0.3	4.3	2.8±0.2	1.3	2.4
D4	7.3±0.3	4.3	3.8±0.2	1.3	2.4

* Externals of figure are the reference.

Characteristics list

Rated voltage (V)	Rated temperature (°C)	Category voltage (V)	Category temperature (°C)	Rated capacitance (µF)	Case size (mm)			Size code	Specifications				Standard		Floor life level	
					L	W	H		Ripple current (mA rms) ^{*1}	ESR (mΩ max.) ^{*2}	tan δ ^{*3}	LC (µA) ^{*4}	Part number	Min. packaging qty (pcs)	Reflow temp ≤260°C	Reflow temp ≤250°C
4.0	105	4.0	105	68	3.5	2.8	1.9	B2	1100	70	0.08	27.2	4TPB68M	2000		3
	105	4.0	105	330	7.3	4.3	2.8	D3L	2000	40	0.10	132	4TPB330ML	2500		2a
6.3	105	6.3	105	33	3.5	2.8	1.9	B2	1100	70	0.08	20.7	6TPB33M	2000	3	3
	105	6.3	105	68	3.5	2.8	1.9		1100	70	0.08	42.8	6TPB68M	2000		
	105	6.3	105	220	7.3	4.3	2.8	D3L	2000	40	0.10	138.6	6TPB220ML	2500		2a
	105	6.3	105		7.3	4.3	2.8		1750	50	0.10	138.6	6TPB220MTL	2500		
	85	5.0	105	330	7.3	4.3	2.8	D3L	2000	40	0.10	207.9	6TPB330MAL	2500		2a
	105	6.3	105		7.3	4.3	2.8		2000	40	0.10	207.9	6TPB330ML	2500		
	105	6.3	105		7.3	4.3	3.8	D4	3000	40	0.10	207.9	6TPB330M	2000		
	105	6.3	105	470	7.3	4.3	2.8	D3L	1850	45	0.10	207.9	6TPB330MVL	2500		
	105	6.3	105		7.3	4.3	3.8	D4	3000	35	0.15	296.1	6TPB470M	2000		
10	105	10	105	33	3.5	2.8	1.9	B2	1100	70	0.08	33.0	10TPB33M	2000	3	
	105	10	105	47	3.5	2.8	1.9		1100	70	0.08	47.0	10TPB47M	2000		
	105	10	105	150	7.3	4.3	2.8	D3L	2000	40	0.10	150.0	10TPB150ML	2500		2a
	105	10	105		7.3	4.3	2.8		1700	55	0.10	150.0	10TPB150MGL	2500		
	105	10	105	220	7.3	4.3	2.8	D3L	2000	40	0.10	220.0	10TPB220ML	2500		-
	105	10	105		7.3	4.3	3.8		3000	40	0.10	220.0	10TPB220M	2000		3
	105	10	105	330	7.3	4.3	3.8	D4	3000	35	0.10	330.0	10TPB330M	2000		-
	105	10	105		7.3	4.3	3.8		2800	40	0.10	330.0	10TPB330MW	2000		

*1: Ripple current (100 kHz / +45 °C)

*2: ESR (100 kHz / +20 °C)

*3: tan δ (120 Hz / +20 °C)

*4: After 5 minutes

◆ Please refer to each page in this catalog for "Reflow conditions", "Taping specifications" and "Floor life level".

Conductive Polymer Tantalum Solid Capacitors

Surface Mount Type

TC series

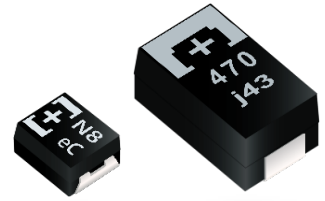

Features

- Guaranteed at 125 °C 1000 h
- RoHS compliance, Halogen free

Specifications

Size code	B2	D2E	D3L	D4
Category temp. range	-55 °C to +125 °C			
Rated volt. range	2.5 V	4.0 V to 6.3 V	2.5 V to 10 V	
Category volt. range	2.0 V	3.2 V to 5.0 V	2.0 V to 8.0 V	
Rated cap. range	330 μF	100 μF to 330 μF	150 μF to 680 μF	330 μF to 1000 μF
Capacitance tolerance	±20 % (120 Hz / +20 °C)			
Leakage current	Please see the attached characteristics list			
Dissipation factor(tan δ)	Please see the attached characteristics list			
Surge voltage (V)	Rated voltage × 1.15			
Endurance	+125 °C 1000 h, category voltage applied			
	Capacitance change	Within ±20 % of the initial value		
	Dissipation factor(tan δ)	≤ 2 times of the initial limit		
	Leakage current	≤ 2 times of the initial limit		
Damp heat (Steady State)	+60 °C, 90 % to 95 % RH, 500 h, No-applied voltage			
	Capacitance change	Within +50 %, -20 % of the initial value (ETCF1000M6H(5H))		
		Within +40 %, -20 % of the initial value		
	Dissipation factor(tan δ)	≤ 1.5 times of the initial limit		
Leakage current	≤ 3 times of the initial limit			

Marking

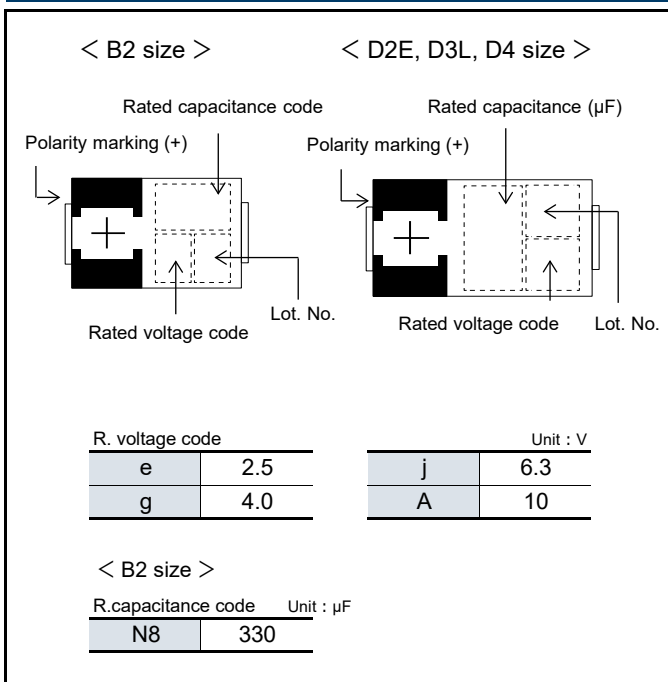

Dimensions (not to scale)

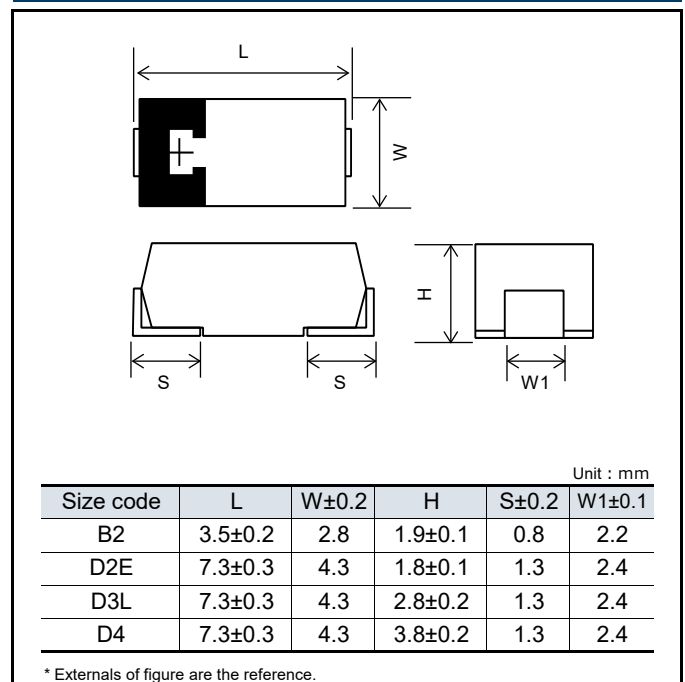

Characteristics list

Series	Rated voltage (V)	Rated temperature (°C)	Category voltage (V)	Category temp. (°C)	Rated capacitance (μF)	Case size (mm)			Size code	Specifications				Standard		Floor life level		
						L	W	H		Ripple current ^{*1} (mA rms)	ESR ^{*2} (mΩ max.)	tan δ ^{*3}	LC ^{*4} (μA)	Part number	Min. packaging q'ty (pcs)	Reflow temp ≤260°C	Reflow temp ≤250°C	
TCE	2.5	105	2.0	125	330	3.5	2.8	1.9	B2	3200	9/300kHz	0.08	165.0	ETCE330M9GB	2000	3	2a	
		105	2.0	125	680	7.3	4.3	2.8	D3L	3500	12	0.10	170.0	ETCE680MCL	2500			
		105	2.0	125		7.3	4.3	2.8		3100	15	0.10	170.0	ETCE680MFL	2500			
		105	2.0	125	1000	7.3	4.3	3.8	D4	3900	15	0.15	250.0	ETCE1000MF	2000			
	4.0	105	3.2	125	150	7.3	4.3	1.8	D2E	2800	18	0.10	60.0	4TCE150MI	3000			
		105	3.2	125	220	7.3	4.3	1.8		3100	15	0.10	88.0	4TCE220MF	3000			
		105	3.2	125		7.3	4.3	1.8		2800	18	0.10	88.0	4TCE220MI	3000			
		105	3.2	125	330	7.3	4.3	1.8		2400	25	0.10	88.0	4TCE220M	3000			
		105	3.2	125		7.3	4.3	1.8		2800	18	0.10	132.0	4TCE330MI	3000			
		105	3.2	125		7.3	4.3	1.8		2400	25	0.10	132.0	4TCE330M	3000			
		105	3.2	125		470	7.3	4.3	2.8	3500	12	0.10	188.0	4TCE470MCL	2500			
		105	3.2	125	7.3		4.3	2.8	3100	15	0.10	188.0	4TCE470MFL	2500				
		105	3.2	125	7.3		4.3	2.8	2800	18	0.10	188.0	4TCE470MIL	2500				
		105	3.2	125	7.3		4.3	2.8	2400	25	0.10	188.0	4TCE470ML	2500				
		6.3	105	5.0	125	100	7.3	4.3	1.8	D2E	2800	18	0.10	63.0	6TCE100MI			3000
			105	5.0	125		7.3	4.3	1.8		2400	25	0.10	63.0	6TCE100M			3000
	105		5.0	125	150	7.3	4.3	1.8	3100		15	0.10	94.5	6TCE150MF	3000			
	105		5.0	125		7.3	4.3	1.8	2800		18	0.10	94.5	6TCE150MI	3000			
	105		5.0	125	220	7.3	4.3	1.8	2400		25	0.15	94.5	6TCE150M	3000			
	105		5.0	125		7.3	4.3	1.8	2800		18	0.15	138.6	6TCE220MI	3000			
	105		5.0	125		7.3	4.3	1.8	2400		25	0.15	138.6	6TCE220M	3000			
	105		5.0	125		330	7.3	4.3	2.8		3100	15	0.10	207.9	6TCE330MFL			2500
	105		5.0	125	7.3		4.3	2.8	2800	18	0.10	207.9	6TCE330MIL	2500				
	105		5.0	125	7.3		4.3	2.8	2400	25	0.10	207.9	6TCE330ML	2500				
	105		5.0	125	470		7.3	4.3	3.8	3500	18	0.15	296.1	6TCE470MI	2000			
	105		5.0	125		7.3	4.3	3.8	3000	25	0.15	296.1	6TCE470M	2000				
	105		5.0	125		680	7.3	4.3	3.8	3500	18	0.15	428.4	6TCE680MI	2000			
	105		5.0	125			7.3	4.3	3.8	3000	25	0.15	428.4	6TCE680M	2000			
	10	105	8.0	125	220	7.3	4.3	2.8	D3L	2800	18	0.10	220.0	10TCE220MIL	2500			
		105	8.0	125		7.3	4.3	2.8		2400	25	0.10	220.0	10TCE220ML	2500			
		105	8.0	125	330	7.3	4.3	3.8	D4	3000	25	0.10	330.0	10TCE330M	2000			
	TCF	2.5	105	2.0	125	680	7.3	4.3	2.8	D3L	4400	6	0.10	170.0	ETCF680M6L			2500
			105	2.0	125		7.3	4.3	2.8		4400	7	0.10	170.0	ETCF680M7L			2500
105			2.0	125	7.3		4.3	2.8	4400		10	0.10	170.0	ETCF680ML	2500			
105			2.0	125	1000	7.3	4.3	3.8	D4	6100	5	0.10	170.0	ETCF680M5H	2000			
105			2.0	125		7.3	4.3	3.8		6100	5	0.10	250.0	ETCF1000M5H	2000			
105			2.0	125		7.3	4.3	3.8		5600	6	0.10	250.0	ETCF1000M6H	2000			
4.0		105	3.2	125	330	7.3	4.3	2.8	D3L	4000	12	0.10	132.0	4TCF330ML	2500			
		105	3.2	125	470	7.3	4.3	2.8		4400	10	0.10	188.0	4TCF470ML	2500			
		105	3.2	125	680	7.3	4.3	3.8		D4	4400	10	0.10	272.0	4TCF680MAH	2000		
6.3		105	5.0	125	220	7.3	4.3	2.8	D3L	6100	5	0.10	138.6	6TCF220M5L	2500			
		105	5.0	125		7.3	4.3	2.8		4600	9	0.10	138.6	6TCF220M9L	2500			
		105	5.0	125		7.3	4.3	2.8		4000	12	0.10	138.6	6TCF220ML	2500			
		105	5.0	125		330	7.3	4.3		2.8	3900	9	0.10	207.9	6TCF330M9L	2500		
		105	5.0	125	470	7.3	4.3	3.8	D4	4400	10	0.10	296.1	6TCF470MAH	2000			
10	105	8.0	125	150	7.3	4.3	2.8	D3L	3600	15	0.10	150.0	10TCF150ML	2500				

*1: Ripple current (100 kHz / +45 °C)

*2: ESR (100 kHz / +20 °C)

*3: tan δ (120 Hz / +20 °C)

*4: After 5 minutes

◆ Please refer to each page in this catalog for "Reflow conditions", "Taping specifications" and "Floor life level".

Conductive Polymer Tantalum Solid Capacitors

Surface Mount Type

TDC series

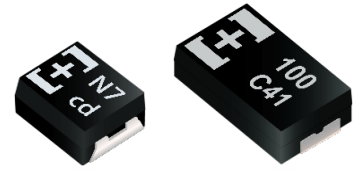

Features

- Guaranteed at 125 °C 1000 h
- High voltage (25 V max.)
- RoHS compliance, Halogen free

Specifications

Size code	B2	D2	D3L
Category temp. range	-55 °C to +125 °C		
Rated volt. range	16 V to 25 V	16 V	16 V to 25 V
Category volt. range	12.8 V to 20 V	12.8 V	12.8 V to 20 V
Rated cap. range	15 µF to 33 µF	100 µF	68 µF to 220 µF
Capacitance tolerance	±20 % (120 Hz / +20 °C)		
Leakage current	Please see the attached characteristics list		
Dissipation factor(tan δ)	Please see the attached characteristics list		
Surge voltage (V)	Rated voltage × 1.15		
Endurance	+125 °C 1000 h, category voltage applied		
	Capacitance change	Within ±20 % of the initial value	
	Dissipation factor(tan δ)	≤ 2 times of the initial limit	
	Leakage current	≤ 2 times of the initial limit	
Damp heat (Steady State)	+60 °C, 90 % to 95 % RH, 500 h, No-applied voltage		
	Capacitance change	Within +40 %, -20 % of the initial value	
	Dissipation factor(tan δ)	≤ 1.5 times of the initial limit	
	Leakage current	≤ 3 times of the initial limit	

Marking

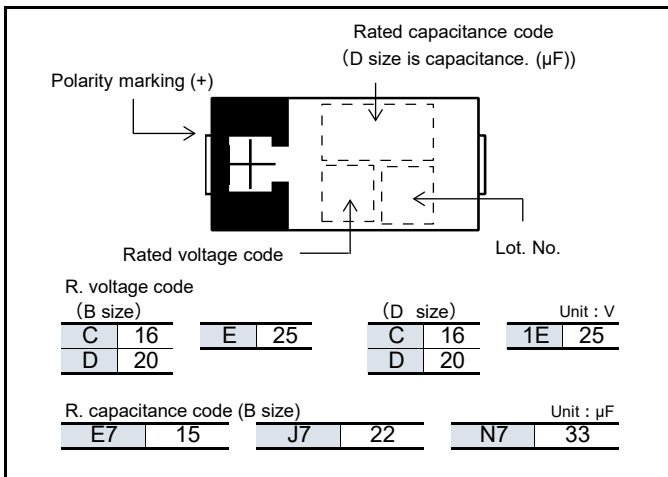

Dimensions (not to scale)

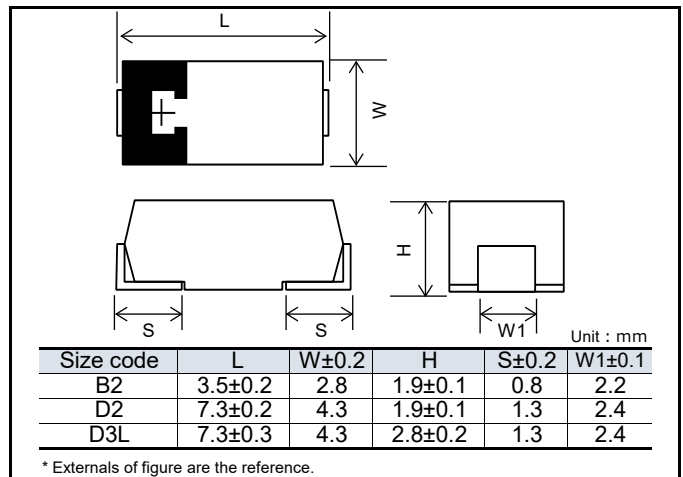

Characteristics list

Rated voltage (V)	Rated temperature (°C)	Category voltage (V)	Category temperature (°C)	Rated capacitance (µF)	Case size (mm)			Size code	Specifications				Standard		Floor life level	
					L	W	H		Ripple current ^{*1} (mA rms)	ESR ^{*2} (mΩ max.)	tan δ ^{*3}	LC ^{*4} (µA)	Part number	Min. packaging q'ty (pcs)	Reflow temp ≤260°C	Reflow temp ≤250°C
16	105	12.8	125	33	3.5	2.8	1.9	B2	1000	90	0.10	158.4	16TDC33MYFB	2000	-	3
	105	12.8	125	100	7.3	4.3	1.9	D2	1800	50	0.10	160.0	16TDC100MYF	3000		
	105	12.8	125	150	7.3	4.3	2.8	D3L	1800	50	0.10	240.0	16TDC150MYF	2500		
NEW	105	12.8	125	220	7.3	4.3	2.8	D3L	1800	50	0.10	240.0	16TDC220MD3	2500		
105	16	125	22	3.5	2.8	1.9	B2	1000	90	0.10	132.0	20TDC22MYFB	2000			
105	16	125	100	7.3	4.3	2.8	D3L	1700	55	0.10	200.0	20TDC100MYF	2500			
20	105	20	125	15	3.5	2.8	1.9	B2	900	100	0.10	112.5	25TDC15MYFB	2000		
	105	20	125	68	7.3	4.3	2.8	D3L	1400	70	0.10	170.0	25TDC68MYF	2500		
25	NEW	105	20	125	100	7.3	4.3	2.8	D3L	1600	60	0.10	250.0	25TDC100MD3	2500	

*1: Ripple current (100 kHz / +105 °C)

*2: ESR (100 kHz / +20 °C)

*3: tan δ (120 Hz / +20 °C)

*4: After 5 minutes

◆ Please refer to each page in this catalog for "Reflow conditions", "Taping specifications" and "Floor life level".



Conductive Polymer Tantalum Solid Capacitors Surface Mount Type TPC series

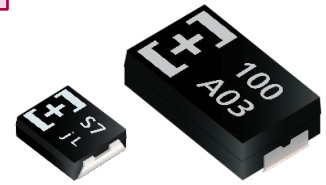

Features

- Low profile (Height 1.1 mm max.)
- RoHS compliance, Halogen free

Specifications

Size code	B1	D2
Category temp. range	-55 °C to +105 °C	
Rated volt. range	6.3 V to 12.5 V	6.3 V to 10 V
Category volt. range	5.0 V to 10 V	6.3 V to 10 V
Rated cap. range	10 μF to 47 μF	68 μF to 330 μF
Capacitance tolerance	±20 % (120 Hz / +20 °C)	
Leakage current	Please see the attached characteristics list	
Dissipation factor(tan δ)	Please see the attached characteristics list	
Surge voltage (V)	Rated voltage × 1.15	
Endurance	+105 °C 2000 h (B1 size : 1000 h) , rated voltage applied	
	Rated temp. +85 °C 1000 h rated voltage applied	
	Capacitance change	Within ±20 % of the initial value
	Dissipation factor(tan δ)	≤ 1.5 times of the initial limit
Damp heat (Steady State)	+60 °C, 90 % to 95 % RH, 500 h, No-applied voltage	
	Capacitance change	Within +40 %, -20 % of the initial value
	Dissipation factor(tan δ)	≤ 1.5 times of the initial limit
	Leakage current	≤ 3 times of the initial limit

Marking

< B1 size >

< D2 size >

j	6.3
k	8.0

A	10
B	12.5

A7	10
E7	15

J7	22
N7	33

S7	47
----	----

Dimensions (not to scale)

Size code	L±0.2	W±0.2	H±0.1	S±0.2	W1±0.1
B1	3.5	2.8	1.1	0.8	2.2
D2	7.3	4.3	1.9	1.3	2.4

* Externals of figure are the reference.

Characteristics list

Rated voltage (V)	Rated temperature (°C)	Category voltage (V)	Category temperature (°C)	Rated capacitance (µF)	Case size (mm)			Size code	Specifications				Standard		Floor life level		
					L	W	H		Ripple current (mA rms)	ESR* ² (mΩ max.)	tan δ* ³	LC* ⁴ (µA)	Part number	Min. packaging q'ty (pcs)	Reflow temp ≤260°C	Reflow temp ≤250°C	
6.3	85	5.0	105	47	3.5	2.8	1.1	B1	1100	55	0.10	29.6	6TPC47M	3000	3		
	85	5.0	105		3.5	2.8	1.1		1000	70	0.10	29.6	6TPC47MB	3000			
	105	6.3	105	100	7.3	4.3	1.9	D2	1700	45	0.10	63.0	6TPC100M	3000			2a
	105	6.3	105	150	7.3	4.3	1.9		1900	40	0.10	94.5	6TPC150M	3000			
	85	5.0	105	330	7.3	4.3	1.9		1900	40	0.10	207.9	6TPC330MA	3000			
8.0	85	6.3	105	22	3.5	2.8	1.1	B1	1000	70	0.10	17.6	8TPC22M	3000	3		
	105	8.0	105	150	7.3	4.3	1.9	D2	1900	40	0.10	120.0	8TPC150M	3000	3		
10	105	10	105	68	7.3	4.3	1.9		1700	45	0.10	68.0	10TPC68M	3000		2a	
	105	10	105		7.3	4.3	1.9		1450	60	0.10	68.0	10TPC68MM	3000			
	105	10	105		7.3	4.3	1.9		1100	100	0.10	68.0	10TPC68ME	3000			
	105	10	105	100	7.3	4.3	1.9		1700	45	0.10	100.0	10TPC100M	3000			
	105	10	105		7.3	4.3	1.9		1600	50	0.10	100.0	10TPC100MT	3000			
	105	10	105		7.3	4.3	1.9		1500	55	0.10	100.0	10TPC100MG	3000			
12.5	85	10	105	10	3.5	2.8	1.1	B1	800	80	0.10	12.5	12TPC10M	3000	3		
	85	10	105	15	3.5	2.8	1.1		800	80	0.10	18.8	12TPC15M	3000			

*1: Ripple current (100 kHz / +45 °C)

*2: ESR (100 kHz / +20 °C)

*3: tan δ (120 Hz / +20 °C)

*4: After 5 minutes

◆ Please refer to each page in this catalog for "Reflow conditions", "Taping specifications" and "Floor life level" .

NRFND

Not recommended for new design

Catalog Deletion Models

The following table is a list of our items which have been deleted from our catalogs.

If you are using any of the following models on the deleted list,

please substitute them with the suggested alternative model as soon as possible.

Our company continue to supply them to customers who have already used them, for the time being.

Series	Size code	Models for deletion	Year of deletion	Alternative model	Series	Size code	Models for deletion	Year of deletion	Alternative model		
TPB	B2	2R5TPB100M	2012	4TPE100MZB	TPG	B1G	10TPG33M	2011	12TPG33M		
		2R5TPB220MA	2009	2R5TPE220MZB			2R5TPG220M	2021	ETPS220MUD		
		4TPB100M	2009	4TPE100MZB			6TPG100M	2021	6TPS150MUD		
		8TPB47M	2009	10TPB47M			6TPG100MG	2021	6TPS150MUD		
		6TPB47M	2009	6TPC47MB			6TPG100MZGD	2021	6TPS150MUD		
		6TPB100MA	2009	6TPE100MAZB			8TPG47M	2021	10TPG47M		
		6TPB100MAV	2009	6TPE100MAZB			B15G	2R5TPG220MUG	2021	ETPS220MUD	
	D3L	2R5TPB330ML	2009	2R5TPE330M				4TPG220M	2021	4TPS220MUD	
		4TPB220ML	2009	4TPE220M		6TPG150M		2021	6TPS150MUD		
		4TPB470ML	2009	4TPE470ML		6TPG150MZG		2021	6TPS150MUD		
		6TPB150ML	2009	6TPC150M	TPSF	B2S	11TPSF62MAIG	2012	--		
	10TPB100ML	2010	10TPC100M	D2		4THC220M	2013	4THE220M			
	D3	4TPB220M	2008	4TPE220M	TH	D3L	2R5THB330ML	2010	--		
		6TPB150M	2008	6TPC150M		10THB100ML	2010	--			
		10TPB100M	2008	10TPC100M		D4	4THB680M	2013	--		
	D4	2R5TPB680M	2009	2R5TPE680MFL	C	16TQC22M	2011	25TQC22MYFD			
		2R5TPB1000M	2009	2R5TPE1000MF		20TQC15M	2011	25TQC15MYFD			
		4TPB470M	2009	4TPE470ML		25TQC10M	2011	25TQC15MYFD			
		4TPB680M	2009	6TPE680MI		D12	16TQC33MYFS	2022	16TQC33MYFD		
	TPC	B1	2R5TPC56M	2012	6TPB68M	TQC	D2	16TQC33M	2012	16TQC33MYFD	
4TPC47M			2012	6TPC47MB	16TQC47M			2012	16TQC47MYFD		
6TPC33M			2012	6TPC47MB	16TQC68MY			2012	16TQC68MYF		
10TPC33MB			2013	12TPG33M	20TQC22M			2012	25TQC22MYFD		
D2		2R5TPC330M	2009	2R5TPE330M	20TQC22MYFD			2015	25TQC22MYFD		
		4TPC150M	2009	4TPE150MI	20TQC47MY			2012	20TQC47MYF		
4TPC220M	2009	4TPE220M	25TQC15M	2012	25TQC15MYFD						
TPE	B2	2TPE330MIB	2011	2TPE330MFB	D3L			16TQC68M	2012	16TQC68MYF	
		2TPE330MAFGB	2011	2TPE330MAFB				20TQC47M	2012	20TQC47MYF	
		2TPE330MFB	2021	ETPE330MFB				25TQC33M	2012	25TQC33MYF	
		2TPE330MAFB	2021	ETPE330MFB		D3	16TQC100M	2012	16TQC100MYF		
		2TPE330MADGB	2021	ETPE330M9GB			16TQS33MBD	2020	--		
		2R5TPE150MZB	2011	2R5TPE220MZB		TQS	B1S	25TQS10MED	2020	--	
		2R5TPE220MIB	2012	2R5TPE220MFGB				35TQS6R8MHD	2020	--	
		ETPE330MAFB	2021	ETPE330MFB				D2E	2R5TPE220MC	2012	2R5TPE220M9
		4TPE150MUB	2013	4TPE150MAZB					2R5TPE220M7	2012	2R5TPE330M7
		D3L	2R5TPE680ML	2012		2R5TPE680MFL	2R5TPE470M		2011	2R5TPE470MI	
	2R5TPE680MIL		2011	2R5TPE680MFL	4TPE150M	2011	4TPE150MI				
	6TPE330MAL		2021	6TPE330ML	D4	2R5TPE1000M	2011		2R5TPE1000MF		
	2R5TPE1000MI		2012	2R5TPE1000MF		2R5TPE680M	2011		6TPE680MI		
	4TPE680M	2011	6TPE680MI	4TPE680MI		2012	6TPE680MI				
	4TPE680MI	2012	6TPE680MI	4TPE680MF		2012	4TPF680MAH				

EOL Models

The following table is a list of the End-Of-Life (EOL) models.

Sales of these items will end as soon as we run out of its stock. We would like to express our appreciation for your business over the years with these products and we hope the new, alternative parts will continue to serve your needs. Thank you very much.

Series	Size code	Models for deletion	Year of deletion	Alternative model	Series	Size code	Models for deletion	Year of deletion	Alternative model
TPA	C	6TPA47M	2012/9	10TPB47M	TPE	B2	2R5TPE220MPB	2012/9	2R5TPE220MLB
		10TPA33M	2012/9	10TPB33M			2R5TPE220MDGB	2013	2R5TPE220MFGB
	D3	4TPA220M	2012/9	4TPE220M		2R5TPE330MFC2	2012/9	2R5TPE330MF	
6TPA150M		2012/9	6TPC150M	2R5TPE330MIC2		2012/9	2R5TPE330MF		
10TPA100M		2012/9	10TPC100M	2R5TPE330MCC2		2012/9	2R5TPE330MC		
TPB	B2	4TPB100MV	2012/9	4TPE100MZB		2R5TPE330M9C2	2012/9	2R5TPE330M9	
		4TPB150MA	2012/9	4TPE150MAZB		4TPE220MFC2	2012/9	4TPE220MF	
		8TPB33M	2012/9	10TPB33M		4TPE220MIC2	2012/9	4TPE220MI	
	C	2R5TPB220MC	2012/9	4TPE220MI		4TPE220MPC2	2012/9	4TPE220MI	
		4TPB150MC	2012/9	6TPE150M		6TPE150MIC2	2012/9	6TPE150MI	
		4TPB220MC	2012/9	4TPE220MI		6TPE150MPC2	2012/9	6TPE150M	
		6TPB100MC	2012/9	6TPG100MG		8TPE100MPC2	2012/9	10TPF150ML	
		6TPB150MC	2012/9	6TPE150M		2R5TPE330MFC	2012/9	2R5TPE330MF	
		8TPB82MC	2012/9	8TPE100MAZB		2R5TPE330MIC	2012/9	2R5TPE330MF	
		10TPB47MC	2012/9	10TPC68M		2R5TPE330MPC	2012/9	2R5TPE330MF	
		10TPB68MC	2012/9	10TPC68M		4TPE220MIC	2012/9	4TPE220MI	
		10TPB220MC	2009/10	–		4TPE220MPC	2012/9	4TPE220MI	
	D3L	2R5TPB470ML	2012/9	2R5TPE470MI		6TPE150MPC	2012/9	6TPE150M	
		2R5TPB680ML	2012/9	2R5TPE680MFL	6TPE220MIC	2012/9	6TPE220MI		
		16TPB47ML	2003/6	16TQC47MYFD	6TPE220MPC	2012/9	6TPE220M		
D3	2R5TPB330M	2012/9	2R5TPE330M	10TPE150MGC	2012/9	10TPE220ML			
	16TPB47M	2003/6	16TQC47MYFD	10TPE180MGC	2012/9	10TPE220ML			
TPC	C1	2R5TPC82M	2012/9	–	D2E	2TPE330M6	2011	2TPF330M6	
		4TPC56M	2012/9	–		2TPE330M7	2011	2R5TPE330M7	
		4TPC100M	2012/9	6TPG100MG		2TPE330M9	2011	2R5TPE330M9	
		6TPC68M	2012/9	6TPG100MG		2TPE470M6	2011	2R5TPF470M6L	
		6TPC100MC	2012/9	6TPG100MG		2TPE470M7	2011	2R5TPE470M7	
	8TPC33M	2012/9	12TPG33M	2TPE470M9		2011	2R5TPE470M9		
	D2	2R5TPC220M	2012/9	2R5TPE220M	2TPF470M6	2012/9	2R5TPF470M6L		
		16TPC33M	2003/6	16TQC33MYFD	–	–	–		
–		–	–	–	–	–			
TPD	D4D	2R5TPD470M	2007/10	2R5TPF470ML	TPF	D2E	4TPF470M5EL	2014	–
		2R5TPD470M5	2012/3	ETPF470M5H		D3L	6TPF330M5EL	2014	–
		2R5TPD470M6	2012/3	2R5TPF470M6L	TPG	B1G	4TPG150M	2012/9	6TPG150M
		2R5TPD470M8	2007/10	2R5TPF470M7L		B15G	6TPG68MG	2012/9	6TPG100M
		2R5TPD680M	2007/10	2R5TPF680ML	TPL	D2T	6TPG220MZG	2014	–
		2R5TPD680M5	2012/3	ETPF680M5H		2R5TPL220MC	2012/9	–	
		2R5TPD680M6	2012/3	2R5TPF680M6L		2R5TPL330M7	2011/7	–	
		2R5TPD680M8	2007/10	2R5TPF680M7L		All models	2013	–	
		2R5TPD1000M	2012/3	ETPF1000M6H		D12T	All models	2013	–
		2R5TPD1000M8	2012/3	ETPF1000M6H	D15T	All models	2013	–	
	2R5TPD1000M6	2012/3	ETPF1000M6H	TPLF	D2T	2TPLF470M7	2012/9	–	
	2R5TPD1000M5	2012/3	ETPF1000M5H		2TPLF560M6	2011/7	–		
	4TPD330M	2007/10	4TPF330ML	TPSF	B2S	All models	2013	–	
	4TPD470M	2007/10	4TPF470ML			2TPSF270MC	2012/9	2TPSF270M9G	
	4TPD680M	2012/3	4TPF680MAH		B1S	2TPSF270M9	2012/9	2TPSF270M9G	
	6TPD220M	2007/10	6TPF220ML	TH	D3L	ETPSF200M9ED	2014	–	
	6TPD330M	2007/10	6TPF330M9L		D4	2R5THB470ML	2012/9	6THB470M	
	6TPD470M	2012/3	6TPF470MAH			2R5THB680M	2012/9	–	
	10TPD150M	2007/10	10TPF150ML		D4D	2R5THB1000M	2012/9	–	
	2R5TPU22M	2012/9	–			2R5THD680M	2012/3	2R5TPF680M6L	
4TPU15M	2012/9	–	4THD470M		2012/9	–			
6TPU10M	2012/9	–	6THD330M	2012/3	6TPF330M9L				
TPU	S08	2R5TPU22MSI	2011	–	TR	TR series	–	TA series	
		2R5TPU47MSI	2018	–	APA	D2A	APA series	2006/4	–
		ETPU100MSI	2018	–	APB	D1	APB series	2006/4	–
		4TPU15MSI	2011	–	APC	D2	APC series	2009/6	–
		4TPU33MSI	2011	–	APD	D1	APD series	2009/6	–
		4TPU68MSI	2018	–	TQC	B15	35TQC2R7MYF	2016	35TQS6R8MHD
		6TPU10MSI	2018	–	TPH	A09	ETPH100MHA	2018	–
		6TPU22MSI	2018	–			4TPH68MHA	2018	–
		6TPU47MSI	2018	–			6TPH47MHA	2018	–
		10TPU4R7MSI	2018	–			6TPH100MAEA	2018	–
	2R5TPU47MSK	2012/9	–	ATPH33MAHA			2018	–	
	2R5TPU68MSK	2013	–	ETPH220MABC			2018	–	
	S11	4TPU33MSK	2012/9	–	A14	ETPH220MAZC	2013	–	
		4TPU47MSK	2013	–		4TPH150MABC	2018	–	
		6TPU22MSK	2012/9	–		6TPH100MABC	2018	–	
		6TPU33MSK	2013	–		–	–	–	
		2R5TPU100MAI	2011	–		–	–	–	
		4TPU68MAI	2011	–		–	–	–	
	A09	6TPU47MAI	2011	–	–	–	–		
		10TPU33MAI	2011	–	–	–	–		
4TPU68MBI		2012/9	–	–	–	–			
B09		6TPU47MBI	2012/9	–	–	–	–		
	6TPU150MBI	2018	–	–	–	–			
	8TPU33MBI	2012/9	–	–	–	–			

Safety Precautions

When using our products, no matter what sort of equipment they might be used for, be sure to confirm the applications and environmental conditions with our specifications in advance.

Panasonic
INDUSTRY

Panasonic Industry Co., Ltd.
Device Solutions Business Division

1006 Kadoma, Kadoma City, Osaka
571-8506 Japan