



Datasheet

GPS/GLONASS/Galileo SMD Patch Antenna

Part No:
SGGP.25.2.A.02

Description:
25*25*2mm GPS/GLONASS/Galileo SMD Patch Antenna

Features:
SMD Direct Mount Ceramic Patch Antenna
GPS/Galileo/GLONASS Antenna
GPS L1/Galileo E1 (1575.42 MHz)
GLONASS L1 (1602 MHz)
Dimensions: 25*25*2mm
RoHS & Reach Compliant

1. Introduction	3
2. Specifications	4
3. Antenna Characteristics	5
4. Radiation Patterns	7
5. Mechanical Drawing	10
6. Evaluation Board	11
7. PCB Footprint Recommendation	12
8. Recommended Reflow Soldering Profile	14
9. Packaging	15
Changelog	17

Taoglas makes no warranties based on the accuracy or completeness of the contents of this document and reserves the right to make changes to specifications and product descriptions at any time without notice. Taoglas reserves all rights to this document and the information contained herein.

Reproduction, use or disclosure to third parties without express permission is strictly prohibited.

Copyright © Taoglas Ltd.



1. Introduction



The SGGP.25.2.A.02 is a ceramic GPS/GLONASS/Galileo passive patch antenna designed for optimal performance on GPS L1/Galileo E1 band (1575.42 MHz) and GLONASS L1 band (1602 MHz). With a low-profile thickness of just 2mm and convenient mounting via standard SMD process, it is ideal for high-volume, low-cost assembly applications. SGGP.25.2.A.02 is designed for applications in navigation devices, vehicle tracking/fleet management systems, and telematics devices. It is an excellent choice for applications in transportation, defense, marine, agriculture, and navigation industries.

This antenna has been tuned for use on a 50mm*50mm ground plane, working at 1575.42MHz and 1602MHz, with a 3.34 dBi gain and 3.32 dBi gain, respectively. 70% efficiency is best in class. The ceramic patch is mounted via reflow process from a pick and place machine. The antenna itself is manufactured and tested in a TS16949 first tier automotive approved facility.

For further information or support with integrating this antenna into your device, please contact your regional Taoglas customer support team.

2. Specifications

GNSS Electrical		
Application Bands	GPS/Galileo	GLONASS
Operation Frequency (MHz)	1575.42 ±1.023	1602±5
Return Loss (dB)	< -10	< -10
Efficiency (%)	78	80
Average Gain (dB)	-1.07	-0.98
Peak Gain (dBi)	3.34	3.32
Impedance	50 ohms	
Mechanical		
Ceramic Dimension	25*25*2mm	
Weight	5.8g	
Enviorinmental		
Operation Temperature	-40°C to 85°C	
Humidity	Non-condensing 65°C 95% RH	
Moisture Sensivity Level (MSL)	3 (168 Hours)	

* Antenna properties were measured with the antenna mounted on 50*50mm Ground Plane

Taoglas Part # SGGPD.25B

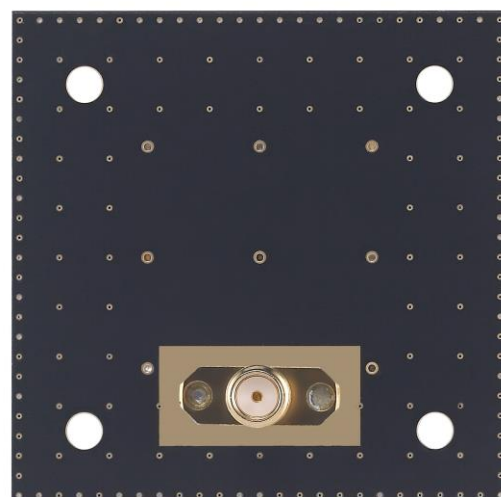

3. Antenna Characteristics

3.1 Return Loss

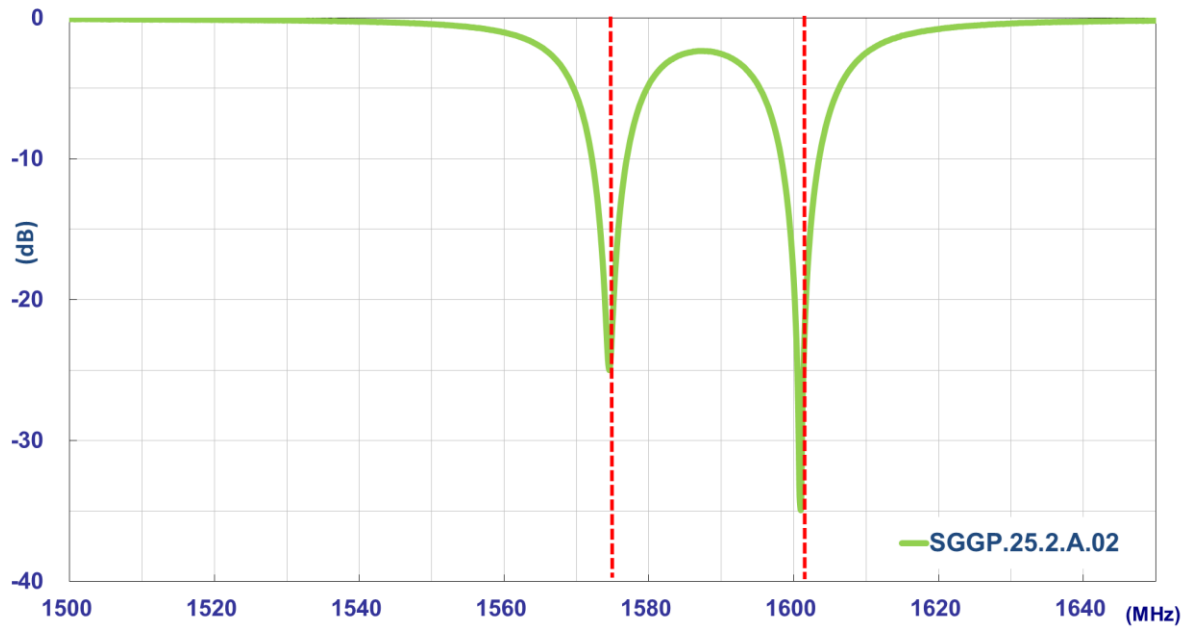

3.2 Efficiency

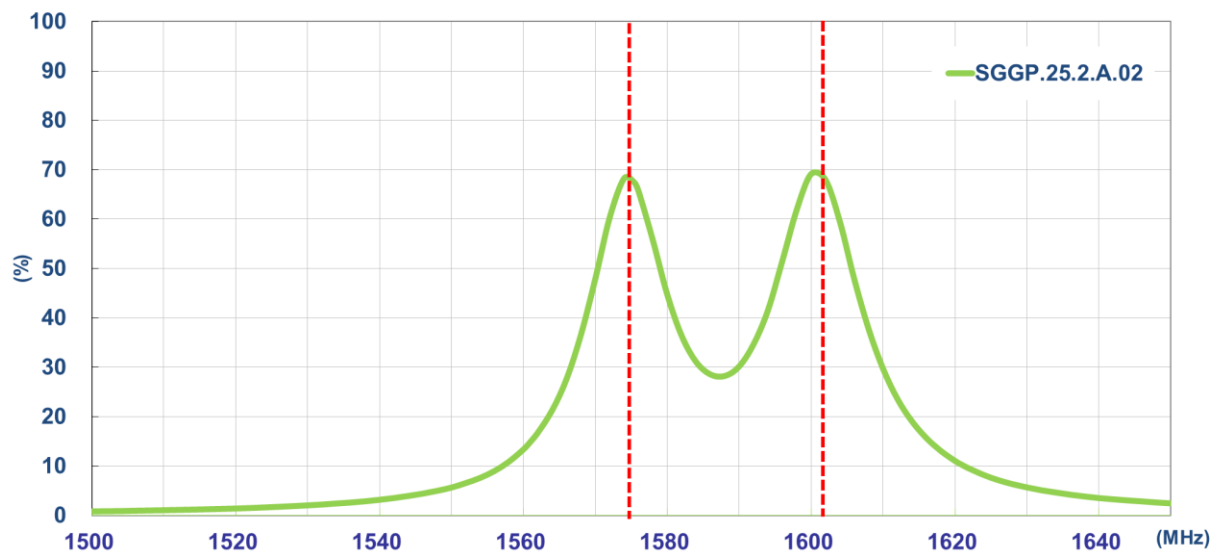

3.3 Average Gain

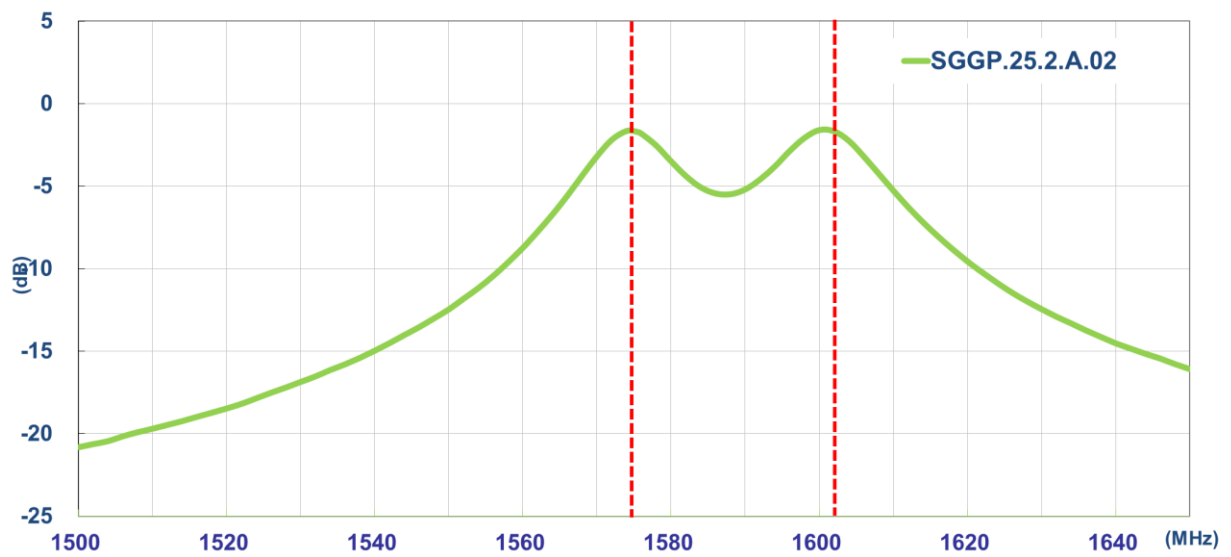

3.4 Peak Gain

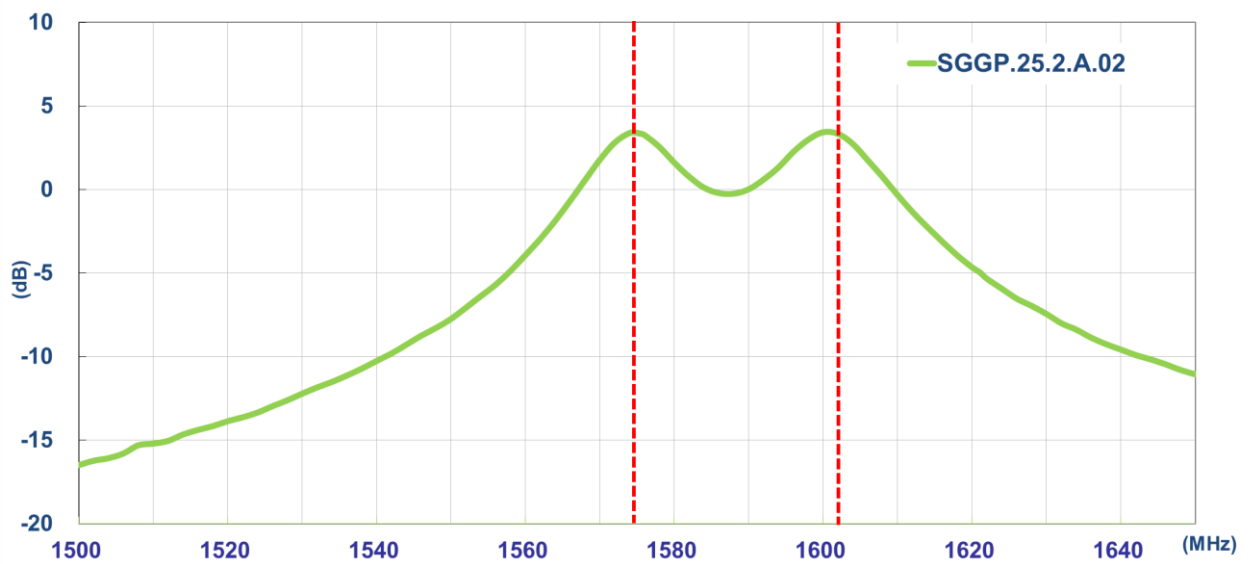

4. Radiation Patterns

4.1 Test Setup

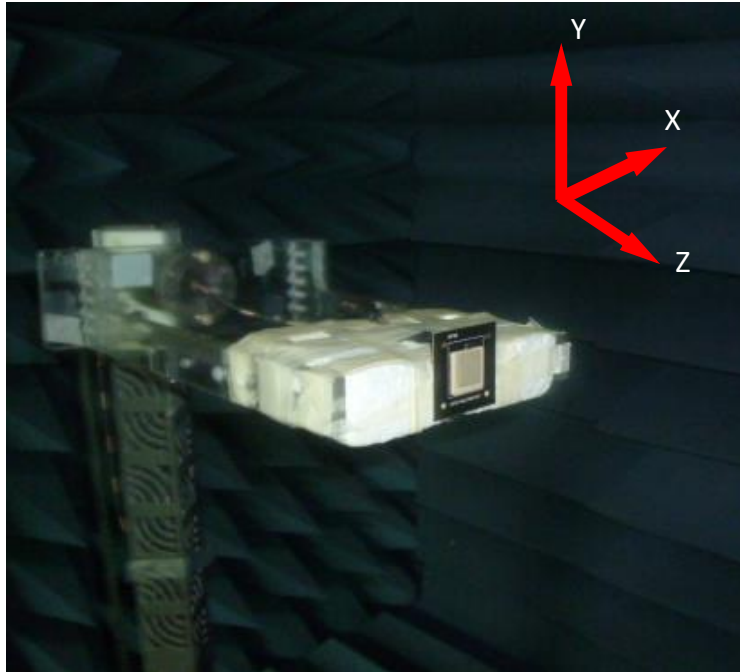

The SGGP.25.2.A.02 antenna is tested with 50mm*50mm ground plane in a CTIA certified ETS-Lindgren Anechoic Chamber. The test setup is shown below.

4.2 2D Radiation Patterns

XY Plane

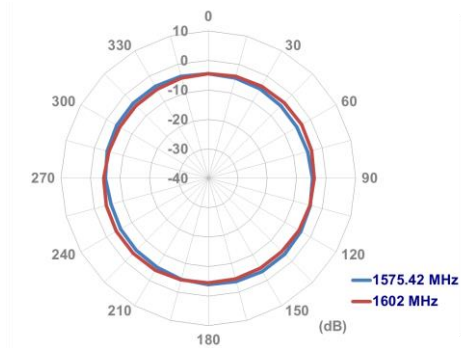

XZ Plane

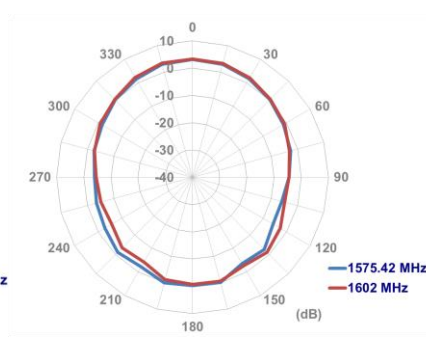

YZ Plane

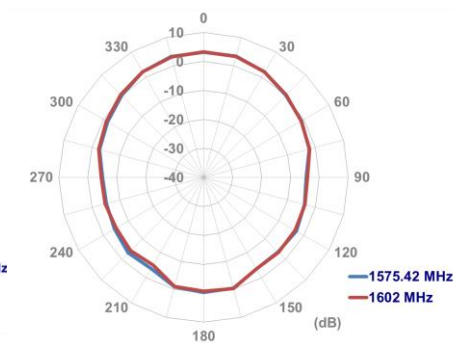

4.3 3D Radiation Patterns

1575.42MHz

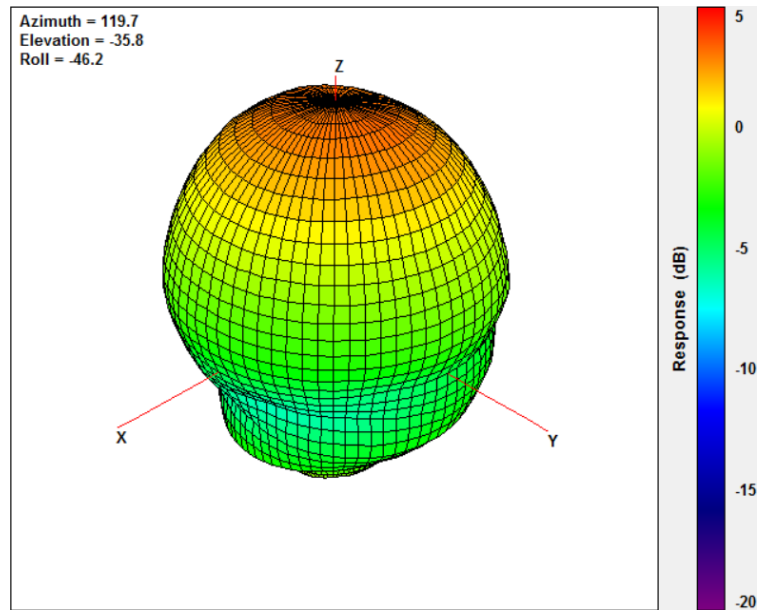

1602MHz

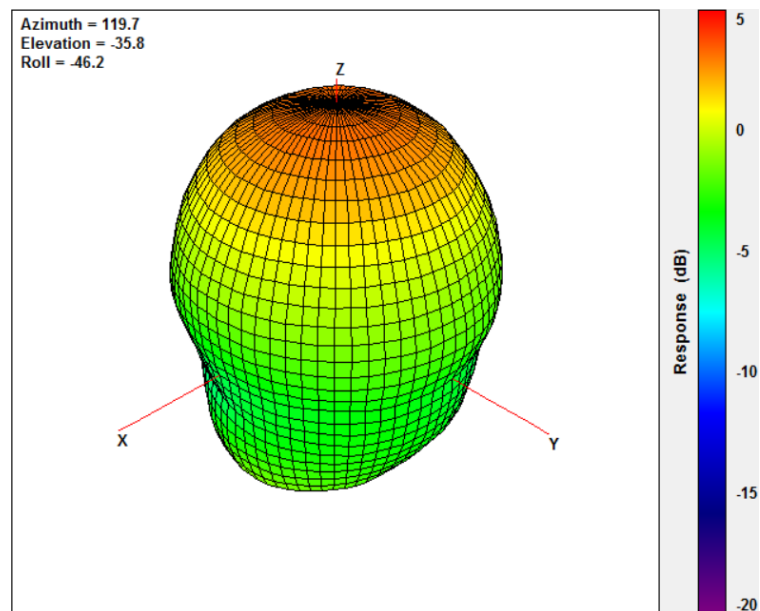

5. Mechanical Drawing (Units: mm)

Top View

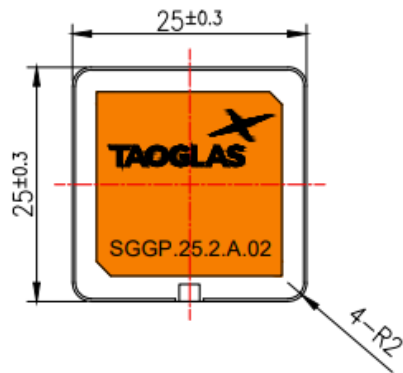

Side View

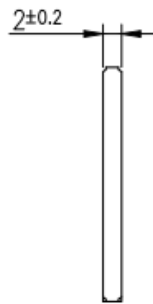

Bottom View

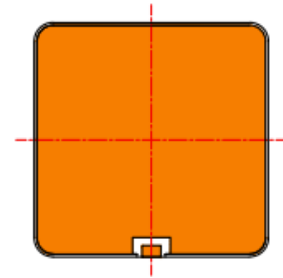

6. Evaluation Board (SGGPD.25B)

6	5	4	3	2	1
ISO NO: EDW-19-8-1421		<Release>		REV	ISSUED DATE
		ALL	Initial Design	Ruby	2019/10/25

Top View

Side View

Bottom View

Notes

- 1. Silver area
- 2. Solder mask
- 3. Solder Area



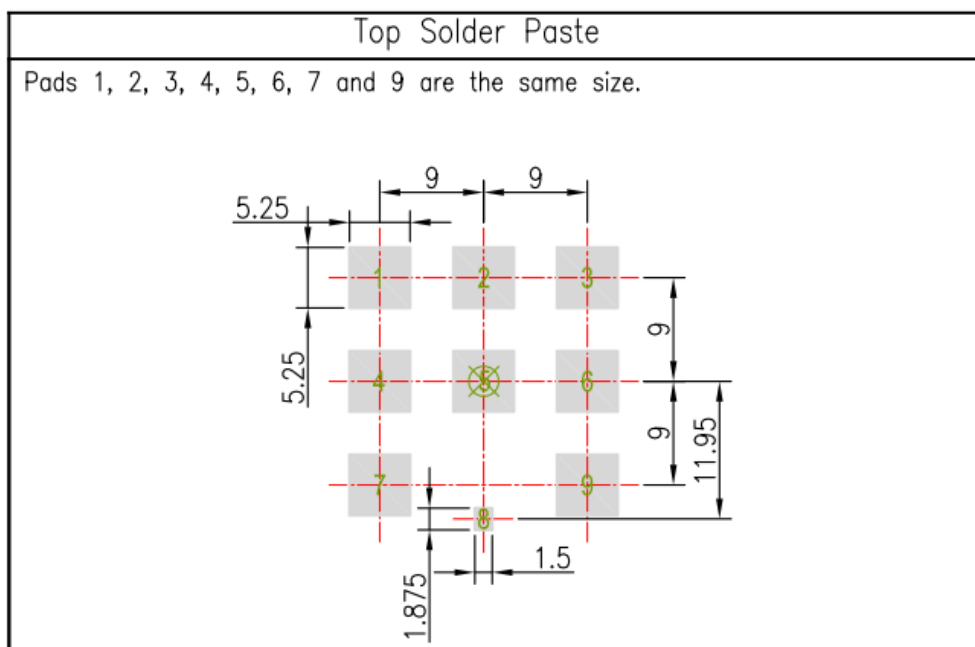
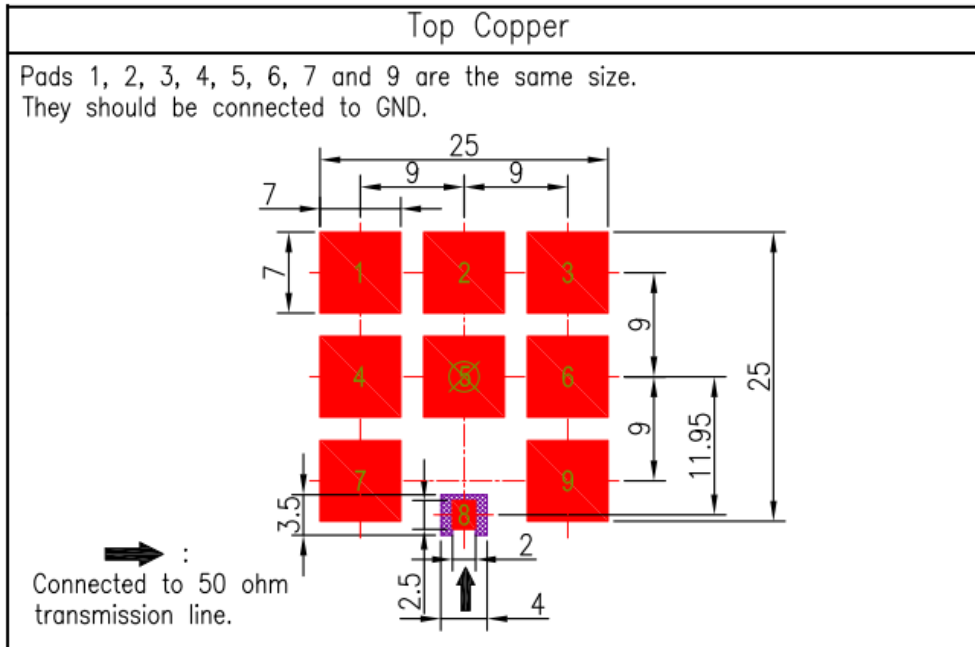

Name	P/N	Material	Finish	QTY
1 PCB SMA(F) ST	200411I000007A	Brass	Au Plated	1
2 SGGP.25.2.A.02 Antenna	001515D030007A	Ceramic	Clear	1
3 PCB	100213D000007A	Composite 1.0t	Black	1

UNLESS OTHERWISE SPECIFIED TOLERANCES ON:		DATE: 2019/10/25	MAT'L:	TW Design Centre <small>This drawing and its inherent design concepts are property of Taoglas. Not to be copied or given to third parties without the written consent of Taoglas.</small>	REV
.X± 0.2		UNIT: mm	FINISH:		D01
XX± 0.5 .XX± 0.1		THIRD ANGLE PROJECTION	SCALE: 1/1		
X± 0.3 .XXX± 0.05		APPROVED BY: Aaron	CHECKED BY: Aaron	DRAWN BY: Ruby	CUSTOMERS SIGNATURE / DATE
		TITLE: :SGGP.25.2.A.02 on 50mm*50mm PCB Ground-Plane with SMA(F) connector			
		PART NO. : SGGPD.25B.E			

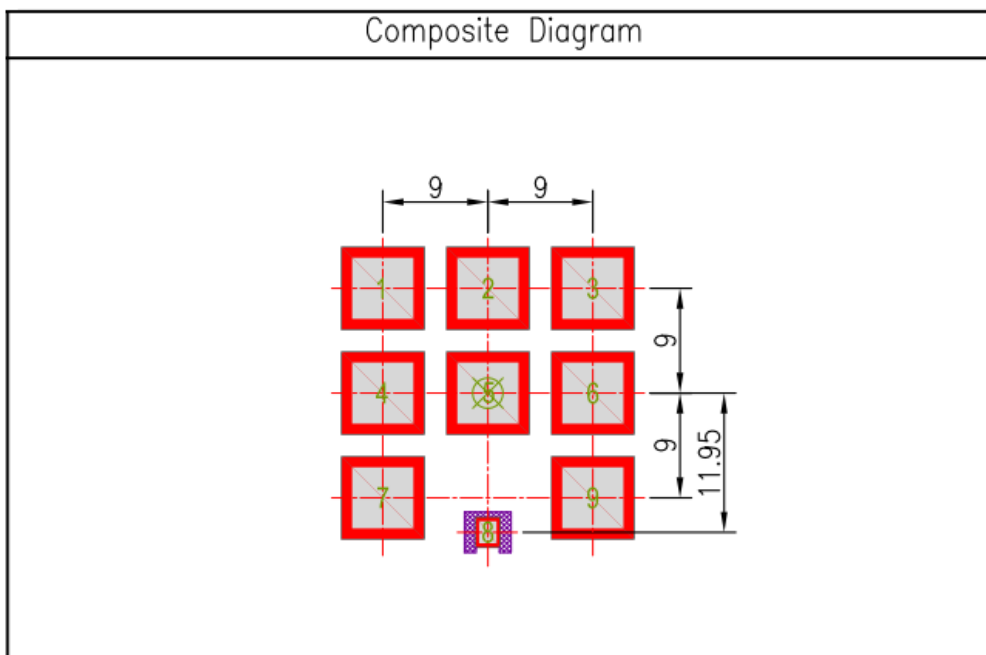
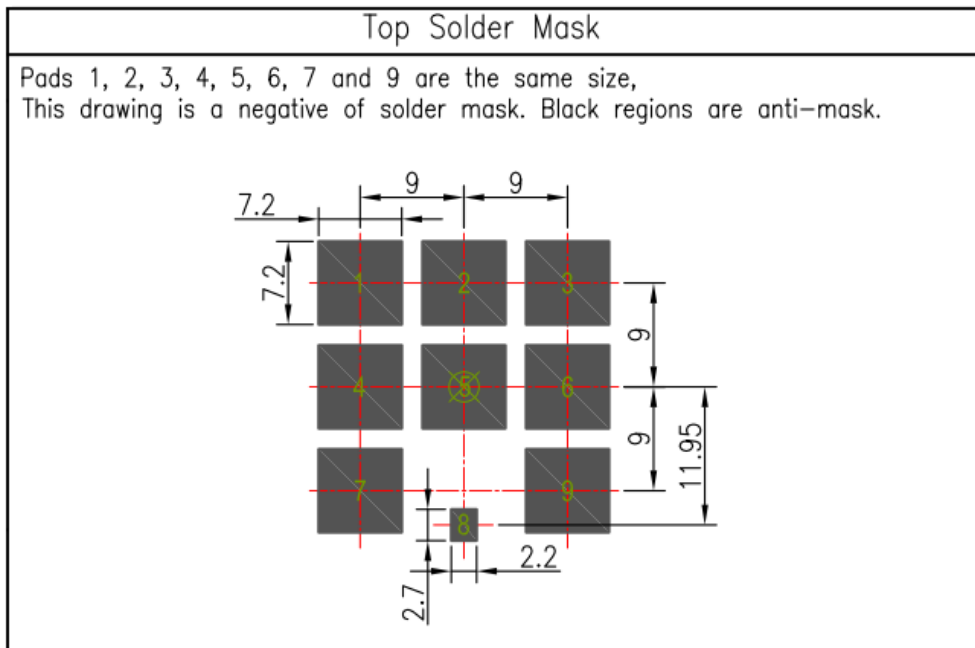
7. PCB Footprint Recommendation





NOTE:			
1. Ag Plated area		6. Copper keepout should extend through all PCB layers.	
2. Solder Mask area		7. Any vias in pads should be either filled or tented to prevent solder from wicking away from the pad during reflow.	
3. Copper area		8. The dimension tolerances should follow standard PCB manufacturing guidelines	
4. Paste area			
5. Copper Keepout Area			

8. Recommended Reflow Soldering Profile

SGGP.12 can be assembled following Pb-free assembly. According to the Standard IPC/JEDEC J-STD-020C, the temperature profile suggested is as follows:

Phase	Profile Features	Pb-Free Assembly (SnAgCu)
Preheat	Temperature Min(T_{smin})	150°C
	Temperature Max(T_{smax})	200°C
	Time(t_s) from (T_{smin} to T_{smax})	60-120 seconds
Ramp-up	Avg. Ramp-up Rate (T_{smax} to T_P)	3°C/second(max)
Reflow	Temperature(T_L)	217°C
	Total Time above T_L (t_L)	30-100 seconds
PEAK	Temperature(T_P)	260°C
	Time(t_p)	2-5 seconds
RAMP-DOWN	Rate	3°C/second(max)
Time from 25°C to Peak Temperature		8 minutes max.
Composition of solder paste		96.5Sn/3Ag/0.5Cu
Solder Paste Model		SHENMAO PF606-P26

The graphic shows temperature profile for component assembly process in reflow ovens

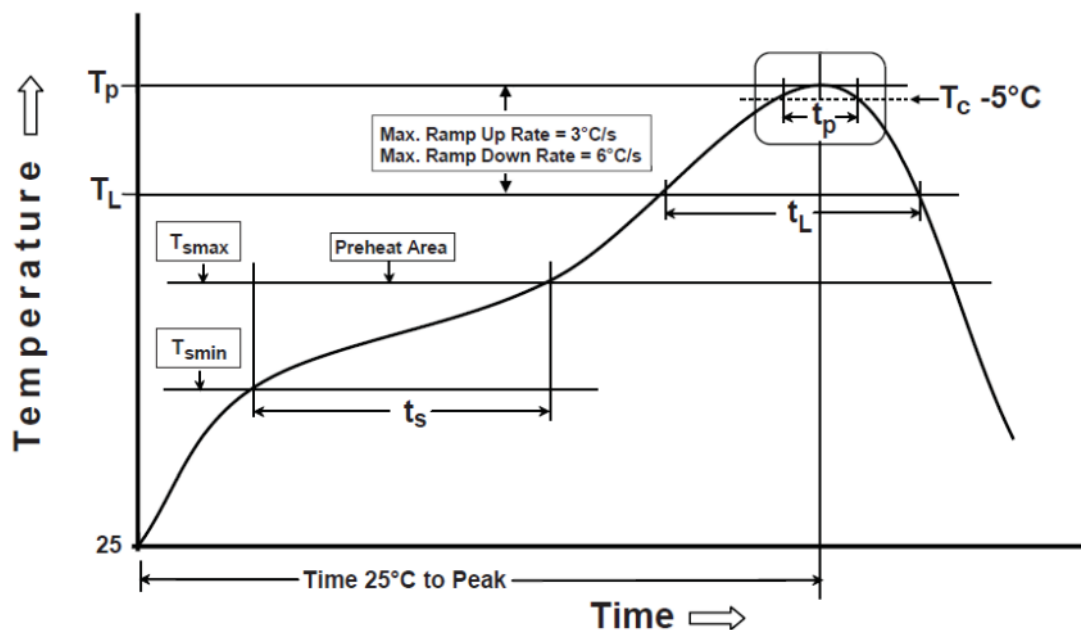

Soldering Iron condition: Soldering iron temperature $270^{\circ}\text{C} \pm 10^{\circ}\text{C}$.

Apply preheating at 120°C for 2-3 minutes. Finish soldering for each terminal within 3 seconds, if soldering iron temperature over $270^{\circ}\text{C} \pm 10^{\circ}\text{C}$ for 3 seconds, it may cause component surface peeling or damage.

7. Packaging

SGGP.25.2.A.02

Packaging Specifications (1/2)

200 pc SGGP.25.2.A.02 per reel
 Dimensions - Ø330*44mm
 Weight - 1.4Kg

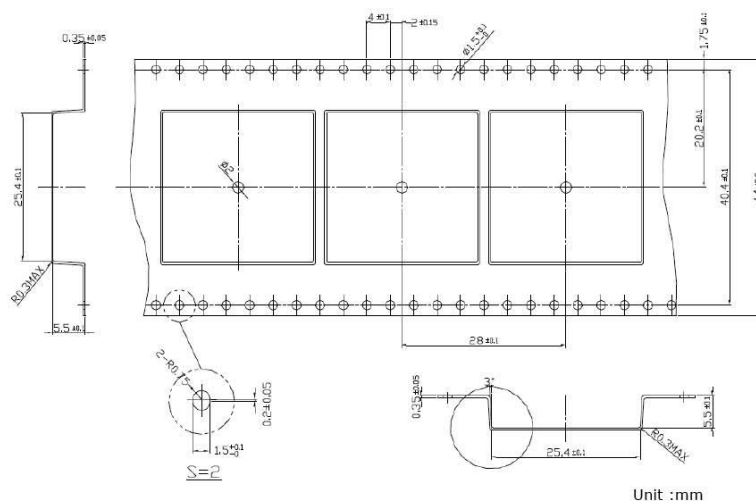
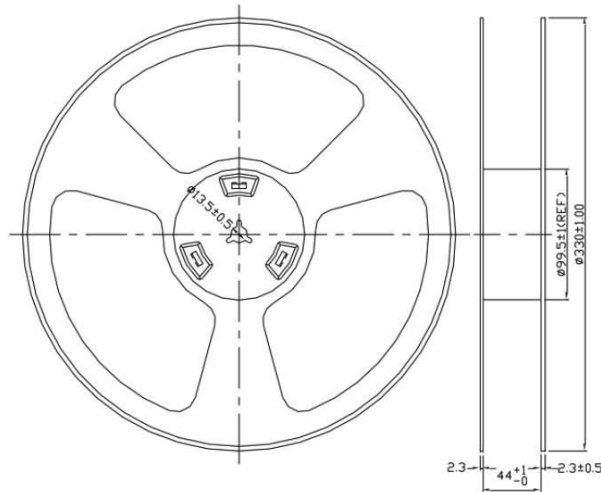

Unit : mm

SGGP.25.2.A.02

Packaging Specifications (2/2)

1 pc reel in small inner box
 Dimensions - 350*340*70mm
 Weight - 1.8Kg

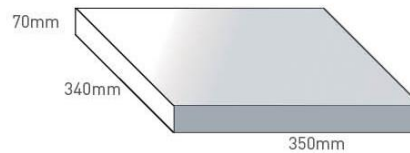

4 Reels / 800 pcs in one carton
 Carton Dimensions - 370*360*305mm
 Weight - 8Kg

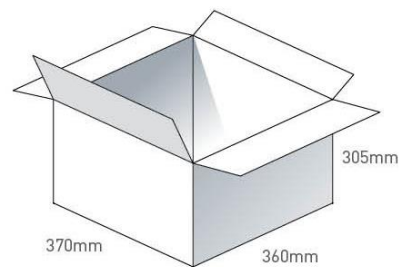

Pallet Dimensions 1100*1220*720mm
 24 Cartons per Pallet
 4 Cartons per layer
 6 Layers

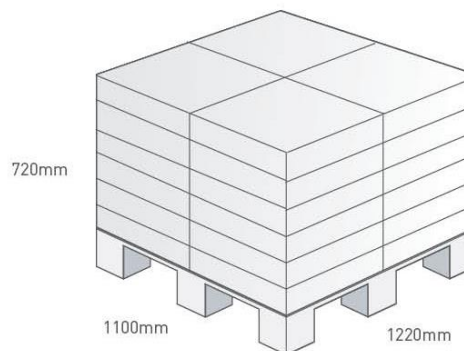

Taoglas makes no warranties based on the accuracy or completeness of the contents of this document and reserves the right to make changes to specifications and product descriptions at any time without notice. Taoglas reserves all rights to this document and the information contained herein.

Reproduction, use or disclosure to third parties without express permission is strictly prohibited.

Copyright © Taoglas Ltd

Changelog for the datasheet

SPE-16-8-001 - SGGP.25.2.A.02

Revision: B (Current Version)

Date:	2022-06-30
Changes:	Updated specification
Changes Made by:	Cesar Sousa

Previous Revisions

Revision: A (Original First Release)

Date:	2016-05-01
Notes:	First Release
Author:	MC



www.taoglas.com

