

## 47 mΩ, 1.2 V to 5.5 V, Low Quiescent Current Load Switch in Ultra Thin μDFN-4

### DESCRIPTION

The SiP32475 is a compact, ultra thin high side load switch that operates over a input voltage range from 1.2 V to 5.5 V. Designed with a p-channel MOSFET featuring an adaptive charge pump gate drive, the SiP32475 provides 47 mΩ switch on-resistance over a wide input voltage range and maintains a low quiescent current level.

The SiP32475 also features slew rate control, reverse blocking when the switch is off, and output discharge. With guaranteed 1 V control logic high, the SiP32475 can interface directly with a low voltage control I/O, without the need for an extra level shift or driver. The device is logic high enabled and a 2.8 MΩ pulldown resistor is integrated at the logic control EN pin. The slow slew rate of the SiP32475 limits the in-rush current and minimizes the switching noise.

The SiP32475 is available in the μDFN-4L 1 mm x 1 mm package with a 0.3 mm thickness. The device is specified for operation over a temperature range of -40 °C to +85 °C.

### FEATURES

- 1.2 V to 5.5 V input voltage range
- 47 mΩ typical on-resistance
- 3 μA quiescent current
- 2 A maximum continuous switch current
- Slew rate controlled turn on: 160 μs
- Guaranteed 1 V logic high over the input voltage range
- Reverse current blocking when the switch is off or  $V_{IN}$  is ground
- Integrated output discharge switch
- ESD performance per JESD 22: 4 kV HBM
- Compact μDFN-4L package with 0.3 mm thickness
- Material categorization: for definitions of compliance please see [www.vishay.com/doc?99912](http://www.vishay.com/doc?99912)



### APPLICATIONS

- PDAs / smart phones
- Notebook / netbook computers
- Tablet PCs
- Portable media players
- Digital cameras
- GPS navigation devices
- Data storage devices
- Medical and healthcare devices

### TYPICAL APPLICATION CIRCUIT

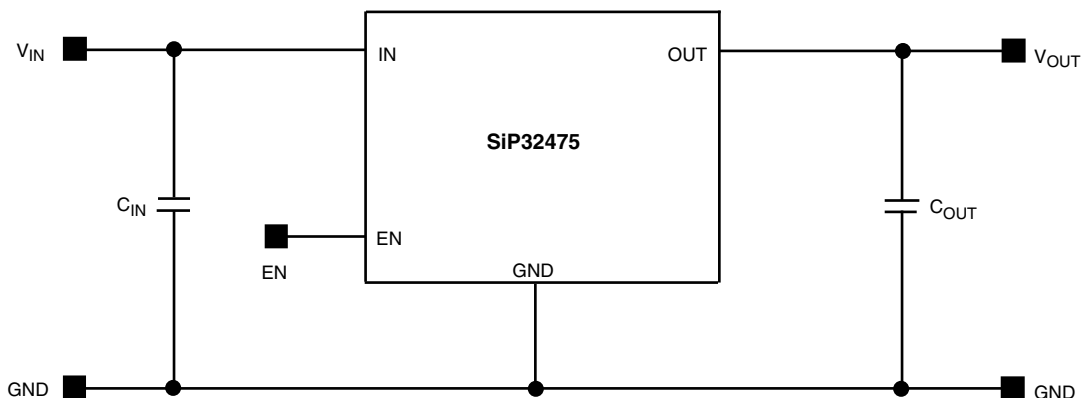

Fig. 1 - Typical Application Circuit

ORDERING INFORMATION					
PART NUMBER	PACKAGE	$t_{on}$ (μs)	$R_{DISCHARGE}$	MARK CODE	TEMPERATURE RANGE
SiP32475DN-T1-GE4	μDFN-4L 1 mm x 1 mm	300	Yes	D	-40 °C to +85 °C



ABSOLUTE MAXIMUM RATINGS			
PARAMETER	CONDITIONS	LIMIT	UNIT
Supply input voltage $V_{IN}$	Reference to GND	-0.3 to 6.5	V
Output voltage $V_{OUT}$	Reference to GND	-0.3 to 6.5	
Output voltage $V_{OUT}$	Pulse at 1 ms reference to GND <sup>a</sup>	-1.6	
Enable input voltage EN	Reference to GND	-0.3 to 6.5	
Maximum continuous switch current		2	A
Maximum pulse switch current	Pulse at 1 ms, 10 % duty cycle	2.5	
ESD rating (HBM)		4000	V
Thermal resistance, junction-to-ambient <sup>b</sup>		150	°C/W
Maximum power dissipation <sup>b</sup>	$T_A = 25\text{ °C}$	650	mW
Temperature			
Operating temperature		-40 to +85	°C
Operating junction temperature		125	
Storage temperature		-65 to +150	

**Notes**

- a. Negative current injection up to 300 mA
- b. Measured on 2 oz double side layer 1" x 1" board

Stresses beyond those listed under "Absolute Maximum Ratings" may cause permanent damage to the device. These are stress ratings only, and functional operation of the device at these or any other conditions beyond those indicated in the operational sections of the specifications is not implied. Exposure to absolute maximum rating conditions for extended periods may affect device reliability.

RECOMMENDED OPERATING RANGE				
ELECTRICAL PARAMETER	MINIMUM	TYPICAL	MAXIMUM	UNIT
Input voltage ( $V_{IN}$ )	1.2	-	5.5	V
Output voltage ( $V_{OUT}$ )	0	-	5.5	

SPECIFICATIONS						
PARAMETER	SYMBOL	TEST CONDITIONS UNLESS OTHERWISE SPECIFIED $V_{IN} = 1.2\text{ V to }5.5\text{ V}$ , $T_A = -40\text{ °C to }+85\text{ °C}$ (typical values are at 25 °C)	LIMITS			UNIT
			MIN.	TYP.	MAX.	
Power Supply						
Quiescent current	$I_Q$	$V_{IN} = 3.3\text{ V}$ , $I_{OUT} = 0\text{ mA}$	-	4.7	7	$\mu\text{A}$
Shutdown current	$I_{SD}$	OUT = GND	-	0.001	2	
Off switch current	$I_{DS(off)}$	EN = GND, OUT = GND	-	0.001	2	
Reverse blocking current	$I_{(in)RB}$	Out = 5 V, IN = 1.2 V, EN = 0 V, (measured at IN pin) Out = 5 V, IN = 0 V, EN = 0 V, (measured at IN pin)	-	0.01 0.12	1 1	
Switch Resistance						
On resistance	$R_{DS(on)}$	$I_{OUT} = 500\text{ mA}$ , $V_{IN} = 1.2\text{ V}$ , $T_A = 25\text{ °C}$	-	92	120	m $\Omega$
		$I_{OUT} = 500\text{ mA}$ , $V_{IN} = 1.5\text{ V}$ , $T_A = 25\text{ °C}$	-	74	90	
		$I_{OUT} = 500\text{ mA}$ , $V_{IN} = 1.8\text{ V}$ , $T_A = 25\text{ °C}$	-	64	80	
		$I_{OUT} = 500\text{ mA}$ , $V_{IN} = 3\text{ V}$ , $T_A = 25\text{ °C}$	-	49	60	
		$I_{OUT} = 500\text{ mA}$ , $V_{IN} = 5\text{ V}$ , $T_A = 25\text{ °C}$	-	47	60	
Discharge switch on resistance	$R_{PD}$	When $V_{IN} = 3\text{ V}$ at 25 °C	-	77	-	$\Omega$
		When $V_{IN} = 1.8\text{ V}$ at 25 °C	-	< 200	-	
EN pin pull down resistor	$R_{EN}$	EN = 1.2 V	1	2.6	6	M $\Omega$
On resistance temperature coefficient	$TC_{RDS}$		-	2800	-	ppm/°C
On/off Logic						
EN input low voltage	$V_{IL}$	$V_{IN} = 1.5\text{ V}$	0.4	-	-	V
EN input high voltage	$V_{IH}$	$V_{IN} = 5.5\text{ V}$	-	-	1	
Switching Speed						
Switch turn-on delay time	$t_{on\_DLY}$	$R_{LOAD} = 500\ \Omega$ , $C_L = 0.1\ \mu\text{F}$ , $V_{IN} = 5\text{ V}$	-	138	-	$\mu\text{s}$
Switch turn-on rise time	$t_r$	$R_{LOAD} = 500\ \Omega$ , $C_L = 0.1\ \mu\text{F}$ , $V_{IN} = 5\text{ V}$	-	162	-	
Switch turn-off delay time	$t_{off\_DLY}$	$R_{LOAD} = 500\ \Omega$ , $C_L = 0.1\ \mu\text{F}$ , (50 % $V_{IN}$ to 90 % $V_{OUT}$ )	-	3	-	

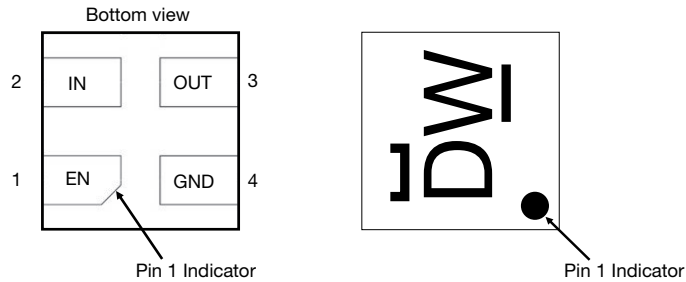
**PIN CONFIGURATION**

**Fig. 2 -  $\mu$ DFN-4L 1 mm x 1 mm**
**DEVICE MARKING**

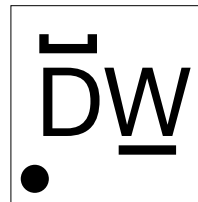
Line 1 : plant code  
 Line 2 : D = device part number  
           W = assembly week  
 Line 3 : pin 1 dot + fab code

**Fig. 3 -  $\mu$ DFN-4L 1 mm x 1 mm**

PIN DESCRIPTION		
PIN#	NAME	FUNCTION
3	OUT	Switch output
2	IN	Switch input
4	GND	Ground connection
1	EN	Switch on/off control. A pull down resistor is integrated

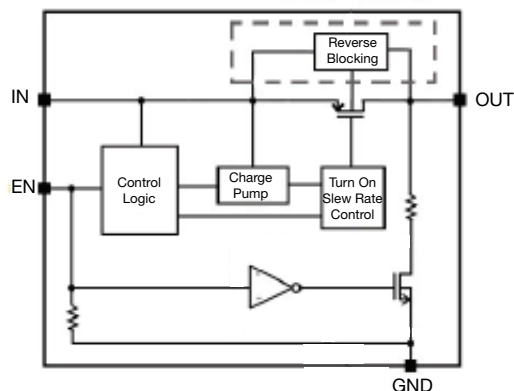
TRUTH TABLE	
EN	SWITCH
1	On
0	Off

**BLOCK DIAGRAM**

**Fig. 4 - Functional Block Diagram**

**TYPICAL CHARACTERISTICS** ( $T_J = 25\text{ }^\circ\text{C}$ , unless otherwise noted)

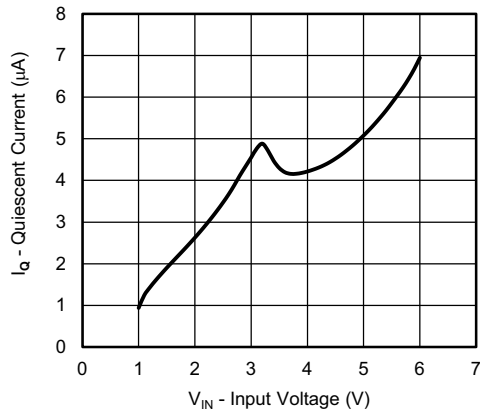

Fig. 5 - Quiescent Current vs. Input Voltage

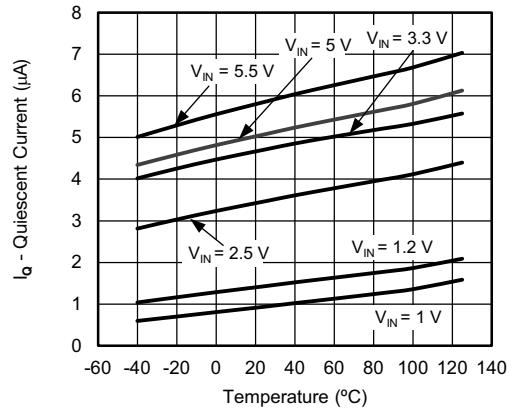

Fig. 8 - Quiescent Current vs. Temperature

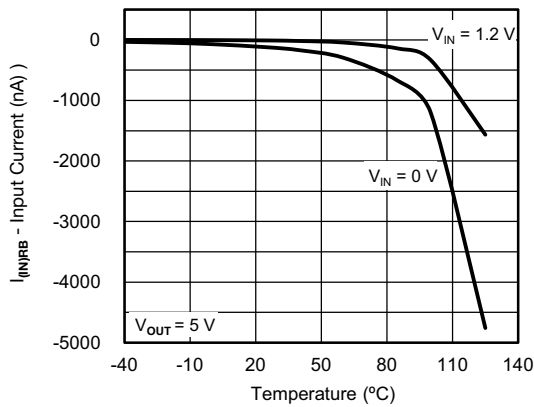

Fig. 6 - Reverse Blocking Current vs. Temperature

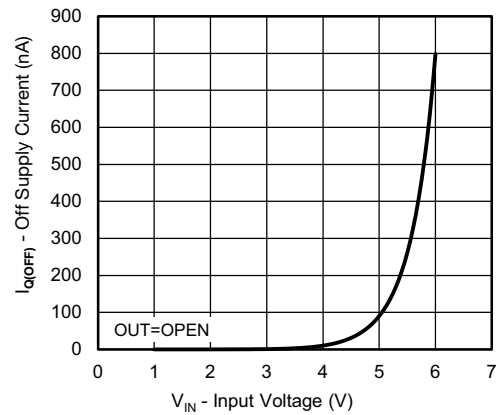

Fig. 9 - Off Supply Current vs. Input Voltage

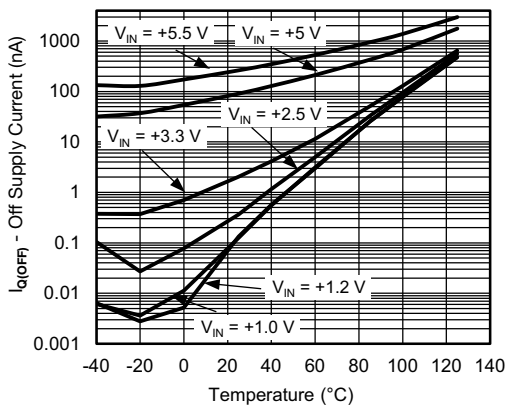

Fig. 7 - Off Supply Current vs. Temperature

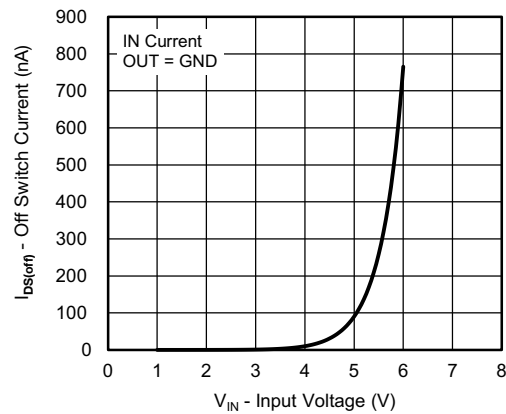
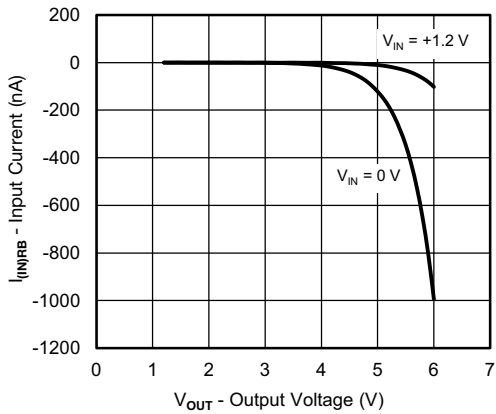
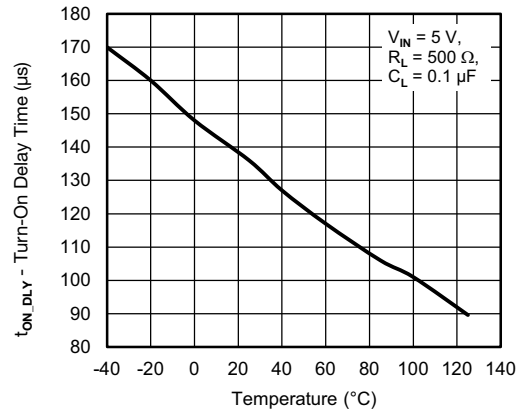

Fig. 10 - Off Switch Current vs. Input Voltage

**TYPICAL CHARACTERISTICS** ( $T_J = 25\text{ }^\circ\text{C}$ , unless otherwise noted)



**Fig. 11 - Reverse Blocking Current vs. Output Voltage**



**Fig. 14 - Turn-on Delay Time vs. Temperature**

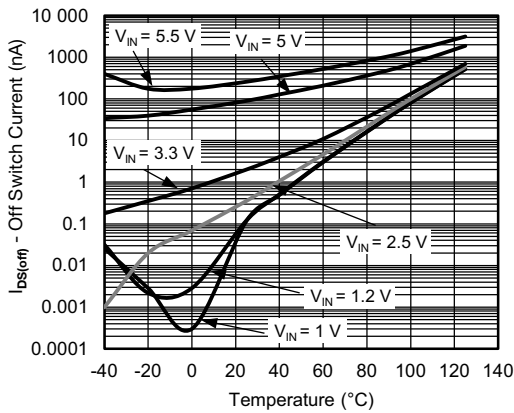

**Fig. 12 - Off Switch Current vs. Temperature**

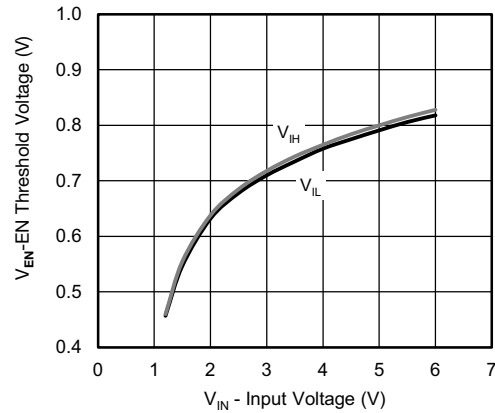

**Fig. 15 - EN Threshold Voltage vs. Input Voltage**

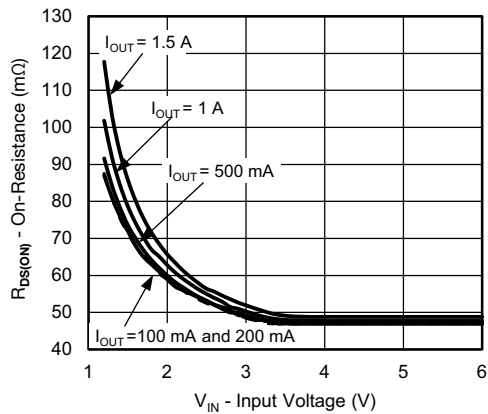

**Fig. 13 -  $R_{DS(on)}$  vs. Input Voltage**

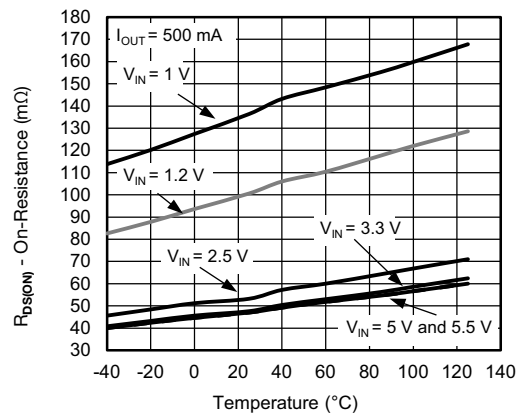

**Fig. 16 -  $R_{DS(on)}$  vs. Temperature**



**TYPICAL CHARACTERISTICS** ( $T_J = 25\text{ }^\circ\text{C}$ , unless otherwise noted)

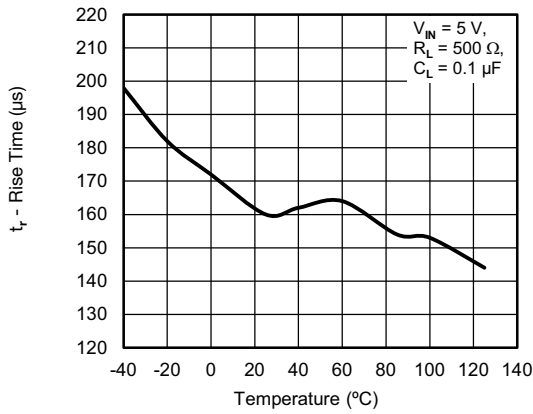

Fig. 17 - Rise Time vs. Temperature

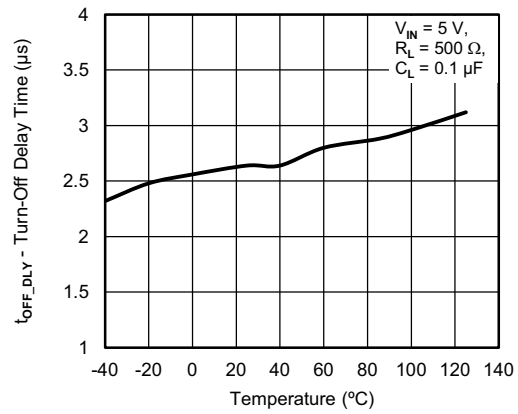

Fig. 18 - Turn-off Delay Time vs. Temperature

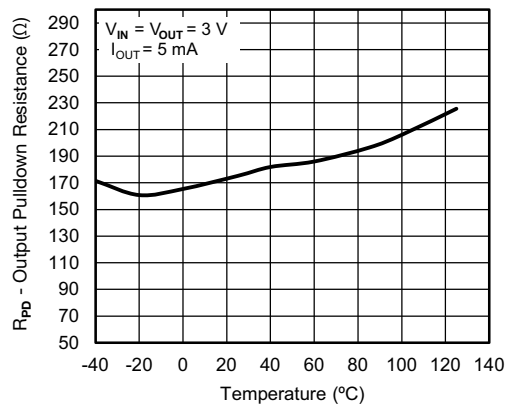

Fig. 19 - Output Pulldown Resistance vs. Temperature

TYPICAL WAVEFORMS

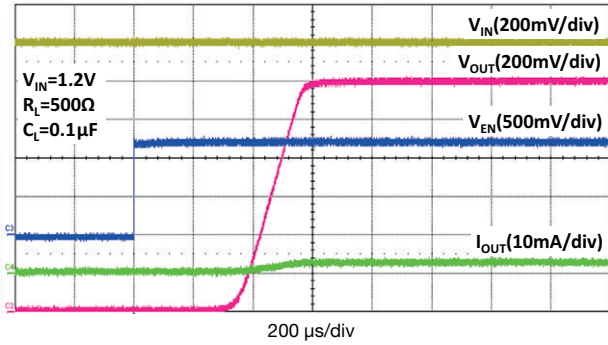

Fig. 20 - Enable Power Up

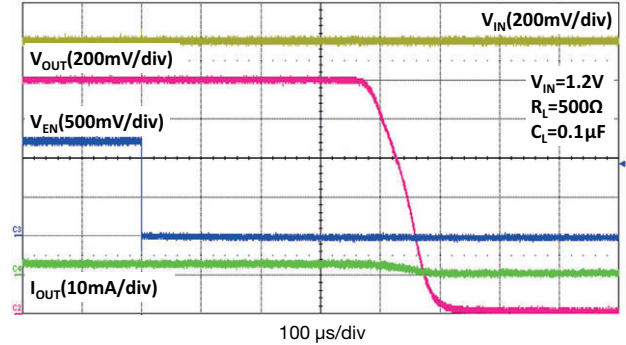

Fig. 23 - Enable Power Down

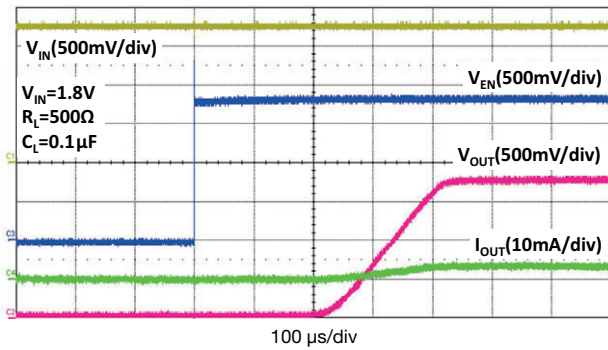

Fig. 21 - Enable Power Up

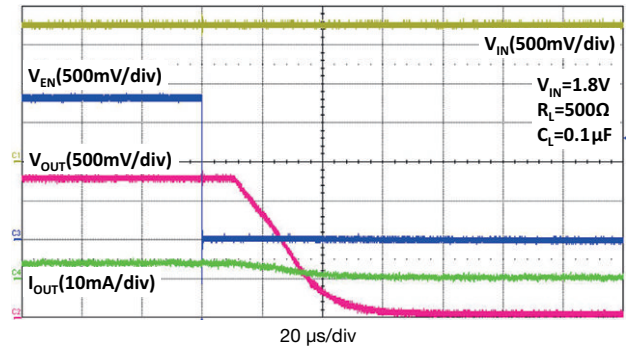

Fig. 24 - Enable Power Down

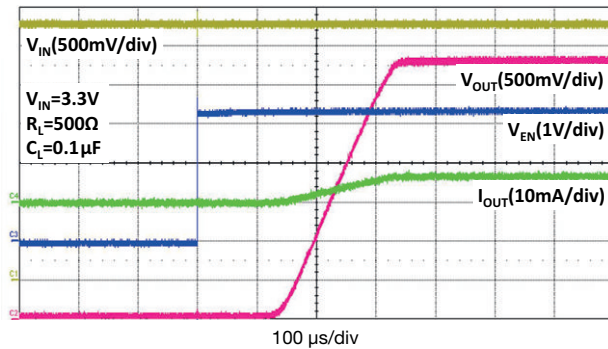

Fig. 22 - Enable Power Up

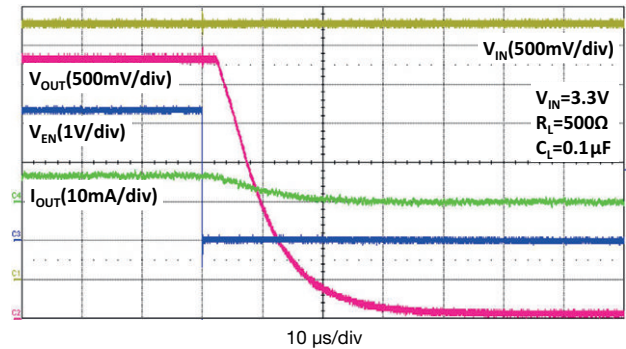
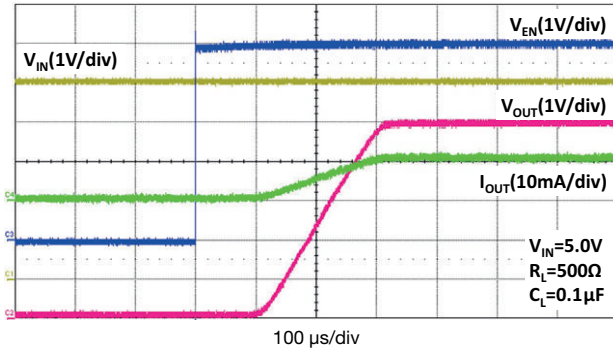
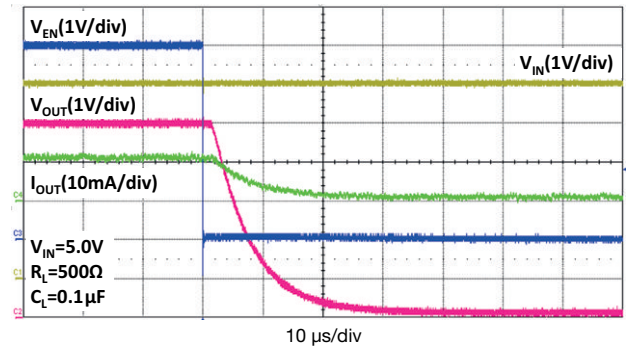
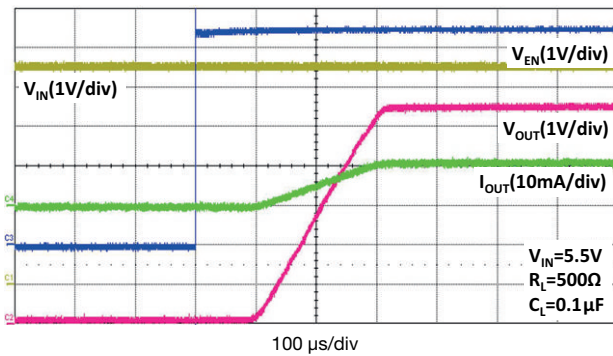
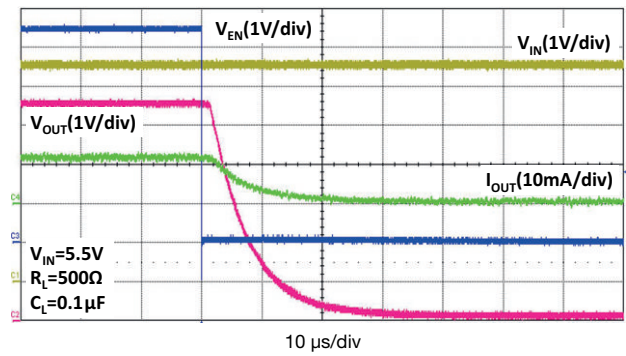
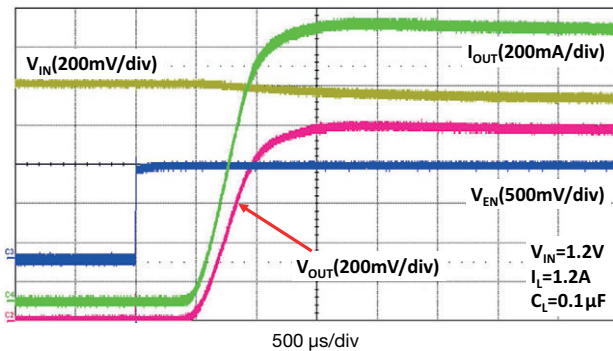
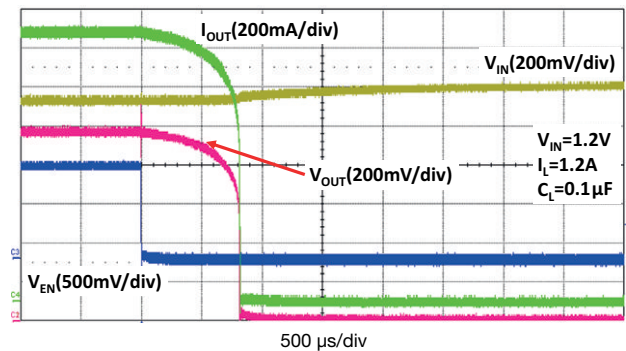
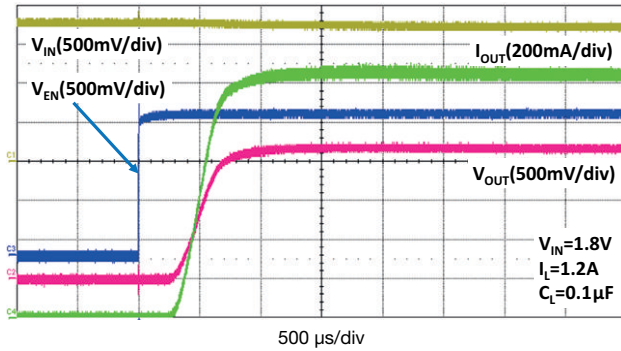
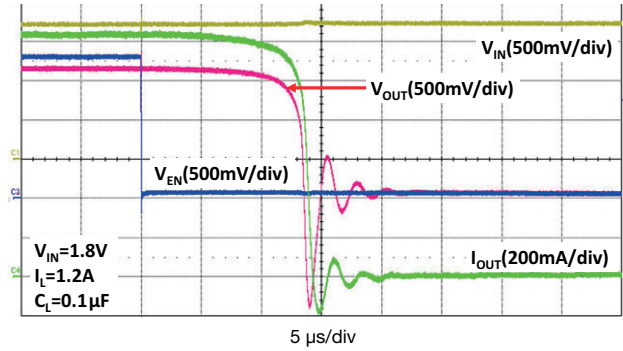
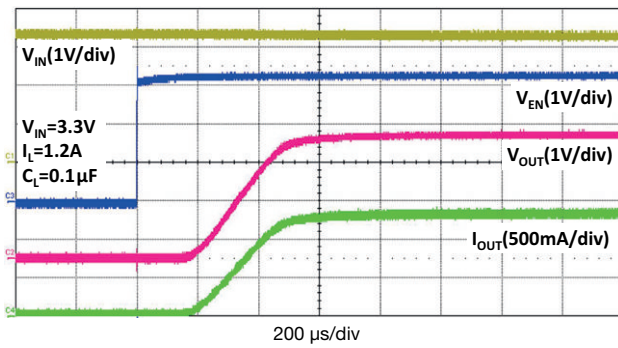
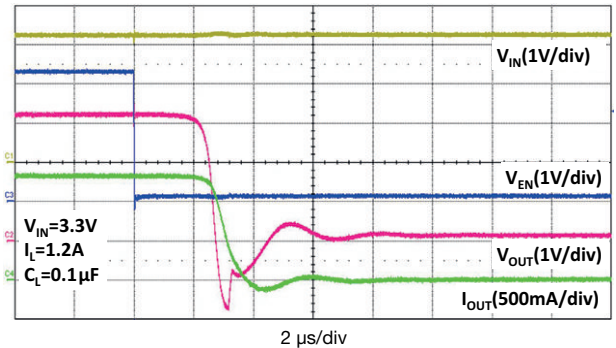
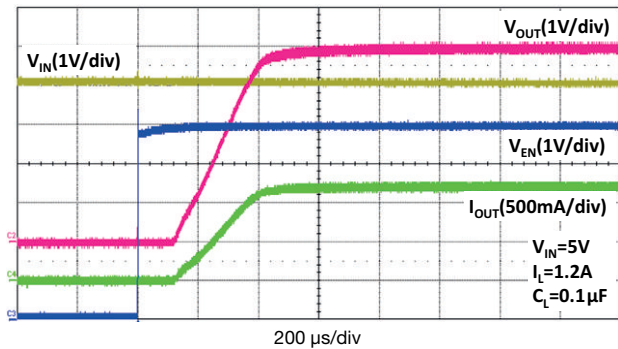
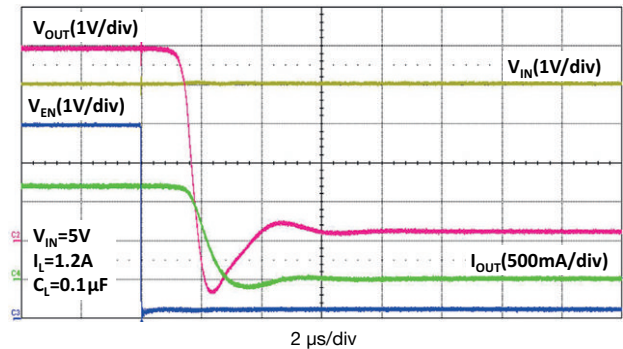

Fig. 25 - Enable Power Down



**TYPICAL WAVEFORMS**

**Fig. 26 - Enable Power Up**

**Fig. 29 - Enable Power Down**

**Fig. 27 - Enable Power Up**

**Fig. 30 - Enable Power Down**

**Fig. 28 - Enable Power Up**

**Fig. 31 - Enable Power Down**



**TYPICAL WAVEFORMS**

**Fig. 32 - Enable Power Up**

**Fig. 35 - Enable Power Down**

**Fig. 33 - Enable Power Up**

**Fig. 36 - Enable Power Down**

**Fig. 34 - Enable Power Up**

**Fig. 37 - Enable Power Down**



**DETAILED DESCRIPTION**

SiP32475 is high side, slew rate controlled, load switch. It incorporates a negative charge pump at the gate to keep the gate to source voltage high when turned on. This keeps the on resistance low at lower input voltages. SiP32475 is designed with slow slew rate to minimize inrush current during turn on. SiP32475 has a reverse blocking circuit, when disabled, to prevent the current from going back to the input when the output voltage is higher than the input voltage. SiP32475 has an output pull down resistor to discharge the output capacitance when the device is off.

**APPLICATION INFORMATION**

**Input Capacitor**

While a bypass capacitor on the input is not required, a 4.7 μF or larger capacitor for C<sub>IN</sub> is recommended in almost all applications. The bypass capacitor should be placed as physically close as possible to the input pin to be effective in minimizing transients on the input. Ceramic capacitors are recommended over tantalum because of their ability to withstand input current surges from low impedance sources such as batteries in portable devices.

**Output Capacitor**

A 0.1 μF capacitor across V<sub>OUT</sub> and GND is recommended to insure proper slew operation. There is inrush current through the output MOSFET and the magnitude of the inrush current depends on the output capacitor, the bigger the C<sub>OUT</sub> the higher the inrush current. There is no ESR or capacitor type requirement.

**Enable**

The EN pin is compatible with CMOS logic voltage levels. It requires at least 0.4 V or below to fully shut down the device and 1 V or above to fully turn on the device. There is a 2.6 MΩ resistor connected between EN pin and GND pin.

**Protection Against Reverse Voltage Condition**

This device contains a reverse blocking circuit. When disabled (V<sub>EN</sub> less than 0.4 V) this circuit keeps the output current from flowing back to the input when the output voltage is higher than the input voltage.

**Thermal Considerations**

Due to physical limitations of the layout and assembly of the device the maximum switch current is 2 A as stated in the

Absolute Maximum Ratings table. However, another limiting characteristic for the safe operating load current is the thermal power dissipation of the package.

The maximum power dissipation in any application is dependent on the maximum junction temperature, T<sub>J(max.)</sub> = 125 °C, the junction-to-ambient thermal resistance, θ<sub>J-A</sub> = 150 °C/W, and the ambient temperature, T<sub>A</sub>, which may be expressed as:

$$P (max.) = \frac{T_{J(max.)} - T_A}{\theta_{JA}} = \frac{125 - T_A}{150}$$

It then follows that, assuming an ambient temperature of 70 °C, the maximum power dissipation will be limited to about 666 mW.

So long as the load current is below the 2 A limit, the maximum continuous switch current becomes a function two things: the package power dissipation and the R<sub>DS(on)</sub> at the ambient temperature.

As an example let us calculate the worst case maximum load current at T<sub>A</sub> = 70 °C. The worst case R<sub>DS(on)</sub> at 25 °C is 120 mΩ at V<sub>IN</sub> = 1.5 V. The R<sub>DS(on)</sub> at 70 °C can be extrapolated from this data using the following formula:

$$R_{DS(on)} (at 70\text{ }^\circ\text{C}) = R_{DS(on)} (at 25\text{ }^\circ\text{C}) \times (1 + T_C \times \Delta T)$$

Where T<sub>C</sub> is 2800 ppm/°C. Continuing with the calculation we have

$$R_{DS(on)} (at 70\text{ }^\circ\text{C}) = 120\text{ m}\Omega \times (1 + 0.0028 \times (70\text{ }^\circ\text{C} - 25\text{ }^\circ\text{C})) = 135\text{ m}\Omega$$

The maximum current limit is then determined by

$$I_{LOAD(max.)} < \sqrt{\frac{P (max.)}{R_{DS(on)}}}$$

which in this case is 2.2 A. Under the stated input voltage condition, if the 2.2 A current limit is exceeded the internal die temperature will rise and eventually, possibly damage the device.

To avoid possible permanent damage to the device and keep a reasonable design margin, it is recommended to operate the device maximum up to 2 A only as listed in the Absolute Maximum Ratings table.



<b>PRODUCT SUMMARY</b>	
Part number	SiP32475
Description	1.2 V to 5.5 V, 47 mΩ, 200 μs rise time, bidirectional off isolation, output discharge
Configuration	Single
Slew rate time (μs)	162
On delay time (μs)	138
Input voltage min. (V)	1.2
Input voltage max. (V)	5.5
On-resistance at input voltage min. (mΩ)	92
On-resistance at input voltage max. (mΩ)	47
Quiescent current at input voltage min. (μA)	1.2
Quiescent current at input voltage max. (μA)	5.5
Output discharge (yes / no)	Yes
Reverse blocking (yes / no)	Yes
Continuous current (A)	2
Package type	μDFN-4L
Package size (W, L, H) (mm)	1.0 x 1.0 x 0.35
Status code	2
Product type	Slew rate
Applications	Computers, consumer, industrial, healthcare, networking, portable

Vishay Siliconix maintains worldwide manufacturing capability. Products may be manufactured at one of several qualified locations. Reliability data for Silicon Technology and Package Reliability represent a composite of all qualified locations. For related documents such as package / tape drawings, part marking, and reliability data, see [www.vishay.com/ppg?75792](http://www.vishay.com/ppg?75792)



## μDFN-4L 1 mm x 1 mm Case Outline

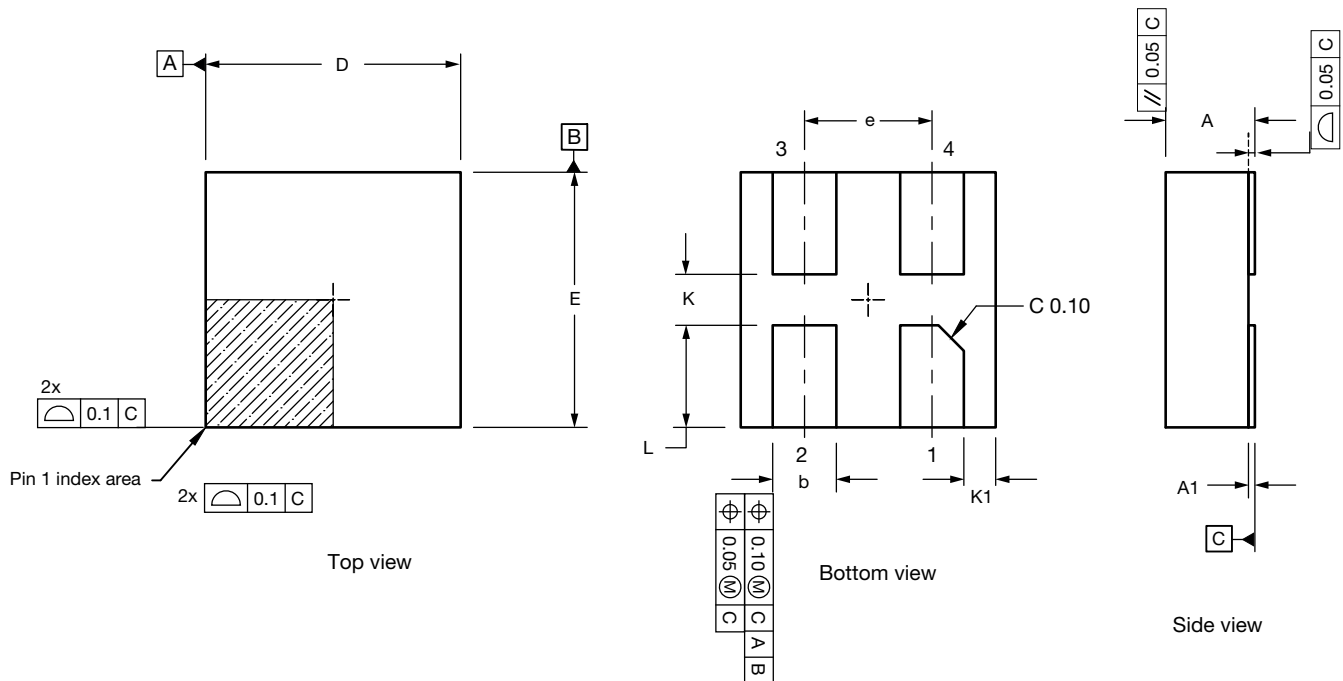

DIM.	MILLIMETERS			INCHES		
	MIN.	NOM.	MAX.	MIN.	NOM.	MAX.
A	0.25	0.30	0.35	0.010	0.012	0.014
A1	0.00	-	0.05	0.000	-	0.002
b	0.20	0.25	0.30	0.008	0.010	0.012
D	0.95	1.00	1.05	0.037	0.039	0.041
E	0.95	1.00	1.05	0.037	0.039	0.041
e	0.50 BSC			0.020 BSC		
K	0.20 Ref.			0.008 Ref.		
K1	0.125 Ref.			0.005 Ref.		
L	0.35	0.40	0.45	0.014	0.016	0.018

ECN: S17-1722-Rev. A, 27-Nov-17  
DWG: 6059

### Notes

- (1) Use millimeters as the primary measurement
- (2) Dimensioning and tolerances conform to ASME Y14.5M-1994
- (3) N is the number of terminals  
Nd and Ne is the number of terminals in each D and E site respectively
- (4) Dimensions b applies to plated terminal and is measured between 0.20 mm and 0.30 mm from terminal tip
- (5) The pin 1 identifier must be existed on the top surface of the package by using indentation mark or other feature of package body
- (6) Package warpage max. 0.05 mm



## Disclaimer

ALL PRODUCT, PRODUCT SPECIFICATIONS AND DATA ARE SUBJECT TO CHANGE WITHOUT NOTICE TO IMPROVE RELIABILITY, FUNCTION OR DESIGN OR OTHERWISE.

Vishay Intertechnology, Inc., its affiliates, agents, and employees, and all persons acting on its or their behalf (collectively, "Vishay"), disclaim any and all liability for any errors, inaccuracies or incompleteness contained in any datasheet or in any other disclosure relating to any product.

Vishay makes no warranty, representation or guarantee regarding the suitability of the products for any particular purpose or the continuing production of any product. To the maximum extent permitted by applicable law, Vishay disclaims (i) any and all liability arising out of the application or use of any product, (ii) any and all liability, including without limitation special, consequential or incidental damages, and (iii) any and all implied warranties, including warranties of fitness for particular purpose, non-infringement and merchantability.

Statements regarding the suitability of products for certain types of applications are based on Vishay's knowledge of typical requirements that are often placed on Vishay products in generic applications. Such statements are not binding statements about the suitability of products for a particular application. It is the customer's responsibility to validate that a particular product with the properties described in the product specification is suitable for use in a particular application. Parameters provided in datasheets and / or specifications may vary in different applications and performance may vary over time. All operating parameters, including typical parameters, must be validated for each customer application by the customer's technical experts. Product specifications do not expand or otherwise modify Vishay's terms and conditions of purchase, including but not limited to the warranty expressed therein.

Hyperlinks included in this datasheet may direct users to third-party websites. These links are provided as a convenience and for informational purposes only. Inclusion of these hyperlinks does not constitute an endorsement or an approval by Vishay of any of the products, services or opinions of the corporation, organization or individual associated with the third-party website. Vishay disclaims any and all liability and bears no responsibility for the accuracy, legality or content of the third-party website or for that of subsequent links.

Except as expressly indicated in writing, Vishay products are not designed for use in medical, life-saving, or life-sustaining applications or for any other application in which the failure of the Vishay product could result in personal injury or death. Customers using or selling Vishay products not expressly indicated for use in such applications do so at their own risk. Please contact authorized Vishay personnel to obtain written terms and conditions regarding products designed for such applications.

No license, express or implied, by estoppel or otherwise, to any intellectual property rights is granted by this document or by any conduct of Vishay. Product names and markings noted herein may be trademarks of their respective owners.