

# Full Function Load Switch with Adjustable Current Limit

## FPF2165R

### Description

The FPF2165R is a load switch which provides full protection to systems and loads which may encounter large current conditions. The device contains a 0.12  $\Omega$  current-limited P-channel MOSFET which can operate over an input voltage range of 1.8–5.5 V. Internally, current is prevented from flowing when the MOSFET is off and the output voltage is higher than the input voltage. Switch control is by a logic input (ON) capable of interfacing directly with low-voltage control signals. The FPF2165R contains thermal shutdown protection, which shuts off the switch to prevent damage to the part when a continuous over-current condition causes excessive heating.

When the switch current reaches the current limit, the part operates in a Constant-Current (CC) mode to prohibit excessive currents from causing damage. The FPF2165R does not turn off after a current limit fault; it remains in the constant current mode indefinitely. The minimum current limit is 150 mA.

The FPF2165R is available in a space-saving 6-pin 2 mm x 2 mm Molded Leadless Package (MLP).

### Features

- 1.8 to 5.5 V Input Voltage Range
- Controlled Turn-On
- 0.15 – 1.5 A Adjustable Current Limit
- $\pm 10\%$  Current Limit Accuracy vs. Temperature
- Under-Voltage Lockout (UVLO)
- Thermal Shutdown
- $< 2 \mu\text{A}$  Shutdown Current
- Fast Current Limit Response Time
  - ◆ 5  $\mu\text{s}$  to Moderate Over Currents
  - ◆ 30 ns to Hard Shorts
- Reverse Current Blocking
- These Devices are Pb-Free and are RoHS Compliant



ON Semiconductor®

[www.onsemi.com](http://www.onsemi.com)

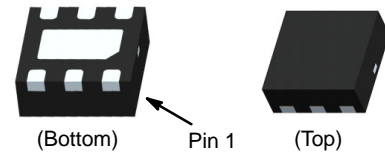

WDFN6 2x2, 065P  
CASE 511CY

### Applications

- PDAs
- Cell Phones
- GPS Devices
- MP3 Players
- Digital Cameras
- Peripheral Ports
- Hot Swap Supplies

### Related Resources

- [FPF2165R Product Information](#)

### ORDERING INFORMATION

Part Number	Current Limit [mA]	Current Limit Blanking Time [ms]	Auto Restart Time [ms]	On Pin Activity	Top Mark	Shipping†
FPF2165R	150 – 1500	0	NA	Active HI	65R	3000 / Tape & Reel

†For information on tape and reel specifications, including part orientation and tape sizes, please refer to our Tape and Reel Packaging Specifications Brochure, BRD8011/D



# FPF2165R

## PIN DESCRIPTIONS

Name	Type	Description
1	ISET	Current Limit Set Input: A resistor from ISET to ground sets the current limit for the switch
2	V <sub>IN</sub>	Supply Input: Input to the power switch and the supply voltage for the IC
3	V <sub>OUT</sub>	Switch Output: Output of the power switch
4	FLAGB	Fault Output: Active LO, open drain output which indicates an over-current supply under-voltage or over-temperature state
5, 7	GND	Ground
6	ON	ON Control Input

## ABSOLUTE MAXIMUM RATINGS

Symbol	Parameter	Min	Max	Unit	
V <sub>IN</sub>	V <sub>IN</sub> , V <sub>OUT</sub> , ON, FLAGB, ISET to GND	-0.3	6.0	V	
P <sub>D</sub>	Power Dissipation		1.2	W	
T <sub>STG</sub>	Operating and Storage Junction Temperature	-65	150	°C	
θ <sub>JA</sub>	Thermal Resistance, Junction to Ambient		86	°C/W	
ESD	Electrostatic Discharge Capability	Human Body Model; JEDEC A1141		V	
		Charged Device Model; JEDEC C101C			
		Machine Model; JEDEC A115			
		IEC 61000-4-2	Air Discharge		15000
			Contact Discharge		8000

Stresses exceeding those listed in the Maximum Ratings table may damage the device. If any of these limits are exceeded, device functionality should not be assumed, damage may occur and reliability may be affected.

## RECOMMENDED OPERATING CONDITIONS

Symbol	Parameter	Min	Max	Unit
V <sub>IN</sub>	Input Voltage	1.8	5.5	V
T <sub>A</sub>	Ambient Operating Temperature	-40	85	°C

Functional operation above the stresses listed in the Recommended Operating Ranges is not implied. Extended exposure to stresses beyond the Recommended Operating Ranges limits may affect device reliability.

# FPF2165R

## ELECTRICAL CHARACTERISTICS

$V_{IN} = 1.8$  to  $5.5$  V,  $T_A = -40$  to  $+85^\circ\text{C}$  unless otherwise noted. Typical values are at  $V_{IN} = 3.3$  V and  $T_A = 25^\circ\text{C}$ .

Symbol	Parameter	Conditions	Min.	Typ.	Max.	Unit	
<b>Basic Operation</b>							
$V_{IN}$	Operating Voltage		1.8		5.5	V	
$I_Q$	Quiescent Current	$I_{OUT} = 1$ mA	$V_{IN} = 1.8$ V		63	100	$\mu\text{A}$
			$V_{IN} = 3.3$ V		68		
			$V_{IN} = 5.5$ V		77	120	
$R_{ON}$	On Resistance	$V_{IN} = 3.3$ V, $I_{OUT} = 200$ mA, $T_A = 25^\circ\text{C}$		120	160	m $\Omega$	
		$V_{IN} = 3.3$ V, $I_{OUT} = 200$ mA, $T_A = 85^\circ\text{C}$		135	180		
		$V_{IN} = 3.3$ V, $I_{OUT} = 200$ mA, $T_A = -40^\circ\text{C}$ to $+85^\circ\text{C}$	65		180		
		$V_{IN} = 5$ V, $I_{OUT} = 200$ mA, $T_A = 25^\circ\text{C}$		95	124		
		$V_{IN} = 5$ V, $I_{OUT} = 200$ mA, $T_A = 85^\circ\text{C}$		110	143		
		$V_{IN} = 5$ V, $I_{OUT} = 200$ mA, $T_A = -40^\circ\text{C}$ to $+85^\circ\text{C}$	58		143		
$V_{IH}$	ON Input Logic High Voltage (ON)	$V_{IN} = 1.8$ V	0.8			V	
		$V_{IN} = 5.5$ V	1.4				
$V_{IL}$	ON Input Logic Low Voltage	$V_{IN} = 1.8$ V			0.5	V	
		$V_{IN} = 5.5$ V			1		
	ON Input Leakage	$V_{ON} = V_{IN}$ or GND	-1		1	$\mu\text{A}$	
	$V_{IN}$ Shutdown Current	$V_{ON} = 0$ V, $V_{IN} = 5.5$ V, $V_{OUT} = \text{Short to GND}$	-2		2	$\mu\text{A}$	
	FLAGB Output Logic Low Voltage	$V_{IN} = 5$ V, $I_{SINK} = 10$ mA		0.05	0.20	V	
		$V_{IN} = 1.8$ V, $I_{SINK} = 10$ mA		0.12	0.30		
	FLAGB Output High Leakage Current	$V_{IN} = 5$ V, Switch On			1	$\mu\text{A}$	

### Reverse Block

	$V_{OUT}$ Shutdown Current	$V_{ON} = 0$ V, $V_{OUT} = 5.5$ V, $V_{IN} = \text{Short to GND}$	-2		2	$\mu\text{A}$
--	----------------------------	---	----	--	---	---------------

### Protections

$I_{LIM}$	Current Limit	$V_{IN} = 3.3$ V, $V_{OUT} = 3.0$ V, $R_{SET} = 1840$ $\Omega$	135	150	165	mA
		$V_{IN} = 3.3$ V, $V_{OUT} = 3.0$ V, $R_{SET} = 361$ $\Omega$	720	800	880	
		$V_{IN} = 3.3$ V, $V_{OUT} = 3.0$ V, $R_{SET} = 196$ $\Omega$	1350	1500	1650	
	Thermal Shutdown	Shutdown Threshold		140		$^\circ\text{C}$
		Return from Shutdown		130		
		Hysteresis		10		
UVLO	Under-Voltage Shutdown	$V_{IN}$ Increasing	1.55	1.65	1.75	V
	Under-Voltage Shutdown Hysteresis			50		mV

### Dynamic

$t_{dON}$	Delay On Time	$R_L = 500$ $\Omega$ , $C_L = 0.1$ $\mu\text{F}$		25		$\mu\text{s}$
$t_{dOFF}$	Delay Off Time	$R_L = 500$ $\Omega$ , $C_L = 0.1$ $\mu\text{F}$		45		$\mu\text{s}$
$t_{RISE}$	$V_{OUT}$ Rise Time	$R_L = 500$ $\Omega$ , $C_L = 0.1$ $\mu\text{F}$		10		$\mu\text{s}$
$t_{FALL}$	$V_{OUT}$ Fall Time	$R_L = 500$ $\Omega$ , $C_L = 0.1$ $\mu\text{F}$		110		$\mu\text{s}$
	Short-Circuit Response Time	$V_{IN} = V_{OUT} = 3.3$ V, Moderate Over-Current Condition		5		$\mu\text{s}$
		$V_{IN} = V_{OUT} = 3.3$ V, Hard Short		30		ns

Product parametric performance is indicated in the Electrical Characteristics for the listed test conditions, unless otherwise noted. Product performance may not be indicated by the Electrical Characteristics if operated under different conditions.

1. Package power dissipation on 1 square inch pad, 2 oz copper board.

TYPICAL PERFORMANCE CHARACTERISTICS

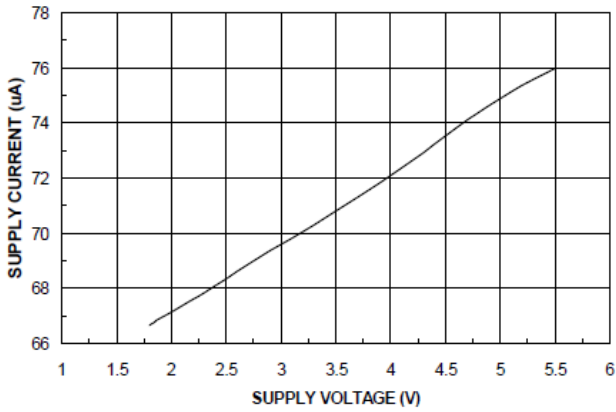

Figure 4. Quiescent Current vs. Input Voltage

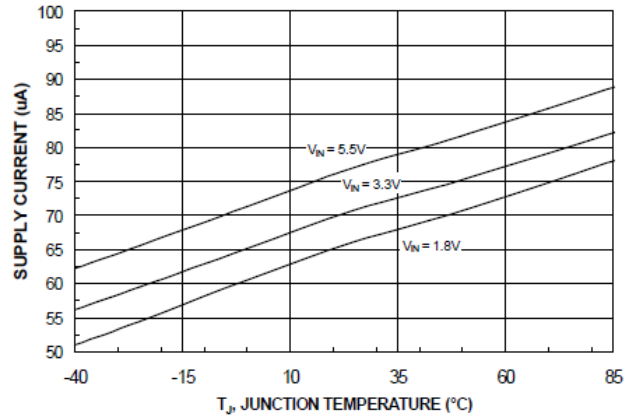

Figure 5. Quiescent Current vs. Temperature

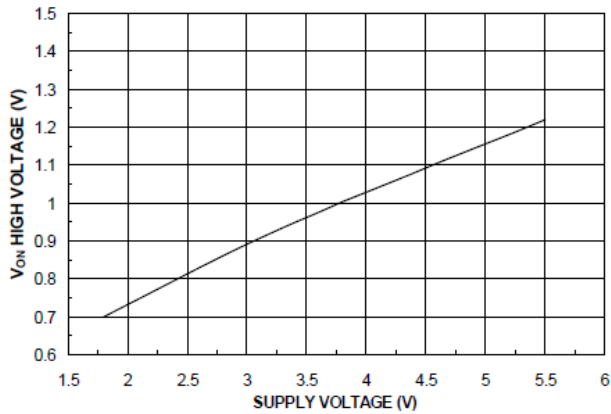

Figure 6.  $V_{ON}$  High Voltage vs. Input Voltage

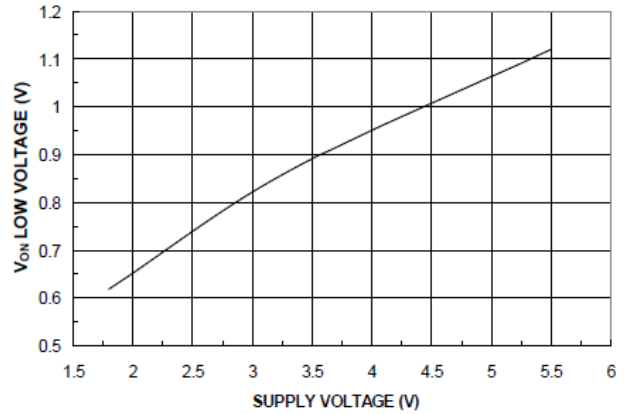

Figure 7.  $V_{ON}$  Low Voltage vs. Input Voltage

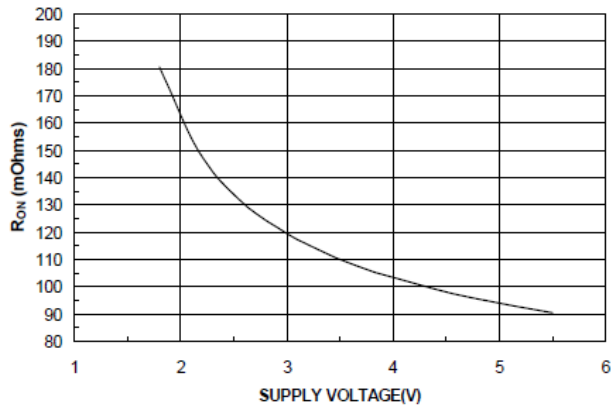

Figure 8.  $R_{ON}$  vs.  $V_{IN}$

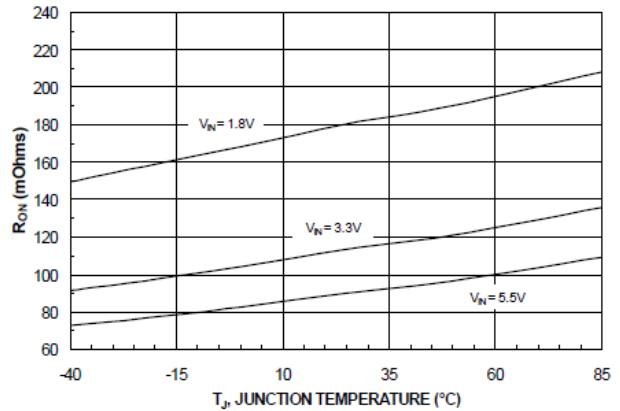

Figure 9.  $R_{ON}$  vs. Temperature

TYPICAL PERFORMANCE CHARACTERISTICS (Continued)

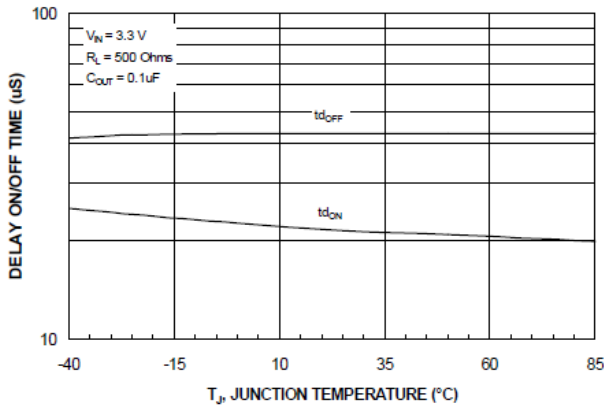

Figure 10.  $t_{dON}$  /  $t_{dOFF}$  vs. Temperature

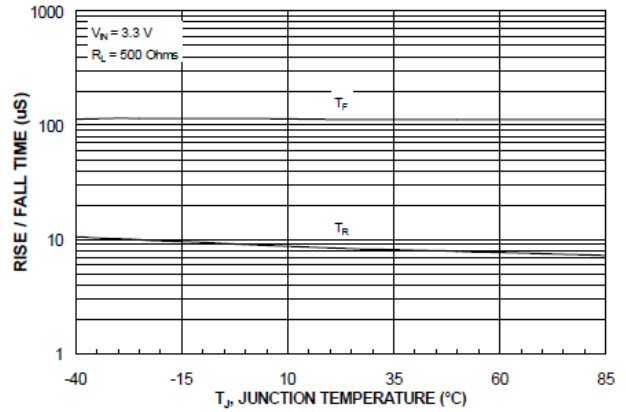

Figure 11.  $T_{RISE}$  /  $T_{FALL}$  vs. Temperature

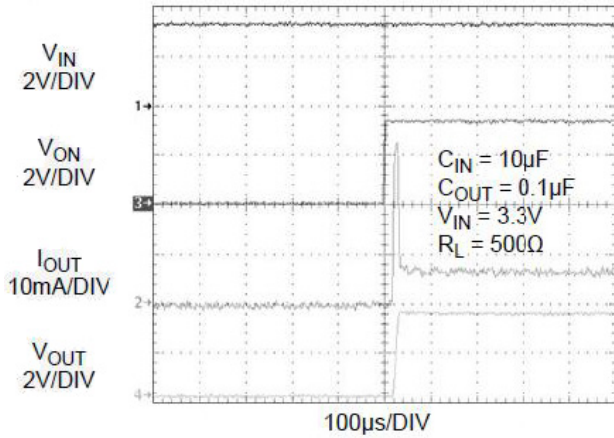

Figure 12.  $t_{dON}$  Response

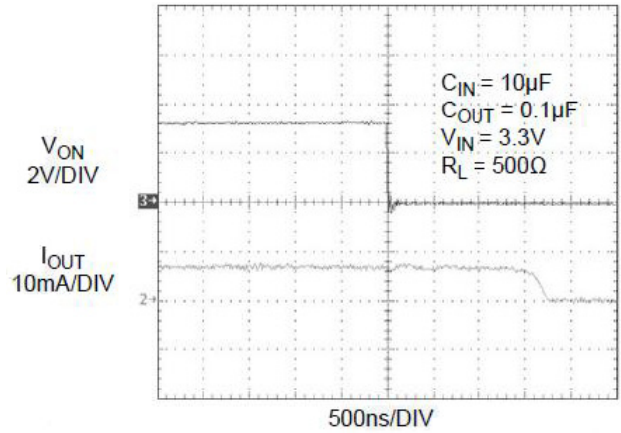

Figure 13.  $t_{dOFF}$  Response

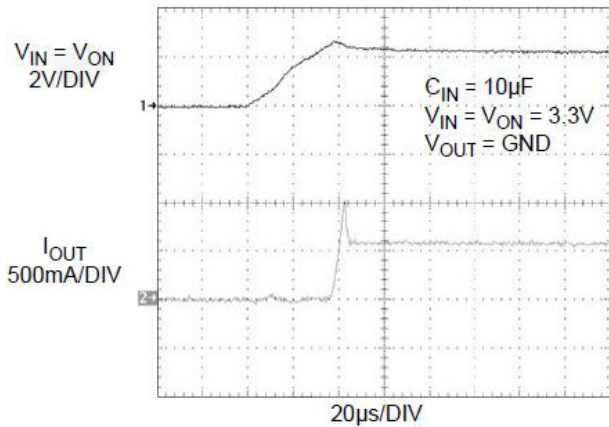

Figure 14. Current Limit Response Time (Switch Powered into Short)

## Description of Operation

The FPF2165R is a current limited switch that protects systems and loads which can be damaged or disrupted by the application of high currents. The core of each device is a 0.12  $\Omega$  P-channel MOSFET and a controller capable of functioning over a wide input operating range of 1.8–5.5 V. The controller protects against system malfunctions through current limiting, under-voltage lockout and thermal shutdown. The current limit is adjustable from 0.15 A to 1.5 A through the selection of an external resistor.

## On/Off Control

The ON pin controls the state of the switch. When ON is high, the switch is in the On state. Activating ON continuously holds the switch in the On state so long as there is no fault. An under-voltage on  $V_{IN}$  or a junction temperature in excess of 140°C overrides the ON control to turn off the switch. The FPF2165R does not turn off in response to an over-current condition but instead remains operating in a constant current mode so long as ON is active and the thermal shutdown or under-voltage lockout have not activated.

The ON pin control voltage and  $V_{IN}$  pin have independent recommended operating ranges. The ON pin voltage can be driven by a voltage level higher than the input voltage.

## Fault Reporting

Upon the detection of an over-current, an input under-voltage, or an over-temperature condition, the FLAGB signals the fault mode by activating LOW. With the FPF2165R, FLAGB is LOW during the faults and immediately returns HI at the end of the fault condition. FLAGB is an open-drain MOSFET which requires a pull-up resistor between  $V_{IN}$  and FLAGB. During shutdown, the pull-down on FLAGB is disabled to reduce current draw from the supply.

## Current Limiting

The current limit ensures that the current through the switch doesn't exceed a maximum value while not limiting at less than a minimum value. The current at which the parts will limit is adjustable through the selection of an external resistor connected to ISET. Information for selecting the resistor is found in the Application Info section. The FPF2165R has no current limit blanking period so it remains in a constant-current state until the ON pin is deactivated or the thermal shutdown turns-off the switch.

For preventing the switch from large power dissipation during heavy load a short circuit detection feature is introduced. Short circuit condition is detected by observing the output voltage. The switch is put into short circuit current limiting mode if the switch is loaded with a heavy load. When the output voltage drops below  $V_{SCTH}$  short circuit detection threshold voltage, the current limit value re-conditioned and short circuit current limit value is decreased to 62.5% of the current limit value. This keeps the power dissipation of the part below a certain limit even at dead short conditions at 5.5 V input voltage. The  $V_{SCTH}$  value is set to be 1 V. At around 1.1 V of output voltage the switch is removed from short circuit current limiting mode and the current limit is set to the current limit value.

## Under-Voltage Lockout

The under-voltage lockout turns-off the switch if the input voltage drops below the under-voltage lockout threshold. With the ON pin active the input voltage rising above the under-voltage lockout threshold causes a controlled turn-on of the switch which limits current over-shoots.

## Reverse Current Blocking

The FPF2165R family has a Reverse Current Blocking feature that protects input source against current flow from output to input. For a standard USB power design, this is an important feature that protects the USB host from being damaged due to reverse current flow on  $V_{BUS}$ . The reverse-current blocking feature is active when the load switch is turned off.

If ON pin is LOW and output voltage becomes greater than input voltage, no current can flow from the output to the input. FLAGB operation is independent of the reverse current blocking and does not report a fault condition if this feature is activated.

## Thermal Shutdown

The thermal shutdown protects the die from internally or externally generated excessive temperatures. During an over-temperature condition the FLAGB is activated and the switch is turned-off. The switch automatically turns-on again if temperature of the die drops below the threshold temperature.

# FPF2165R

## APPLICATIONS INFORMATION

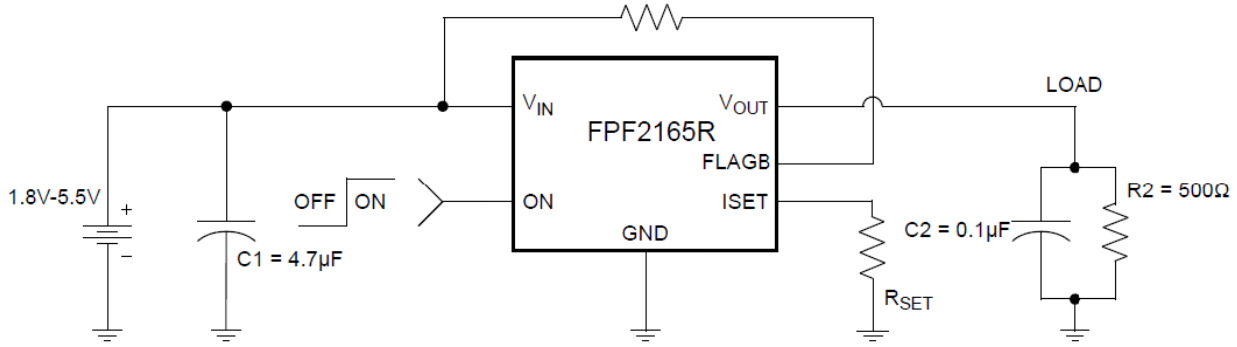

Figure 15. Typical Application

### Setting Current Limit

The FPF2165R has a current limit which is set with an external resistor connected between ISET and GND. This resistor is selected by using equation (1),

$$I_{LIM} = 340.1 \times R_{SET}^{-1.0278} \quad (\text{eq. 1})$$

Table 1 can be used to select  $R_{SET}$ . A typical application would be the 500 mA current that is required by a single USB port. Using Table 1 an appropriate selection for the RSET resistor would be 570  $\Omega$ .

Table 1. CURRENT LIMIT VARIOUS  $R_{SET}$  VALUES

$R_{SET}$ [ $\Omega$ ]	Min. Current Limit [mA]	Typ. Current Limit [mA]	Max. Current Limit [mA]
1840	135	150	165
1391	180	200	220
937	270	300	330
708	360	400	440
632	405	450	495
570	450	500	550
478	540	600	660
411	630	700	770
361	720	800	880
322	810	900	990
290	900	1000	1100
265	990	1100	1210
243	1080	1200	1320
225	1170	1300	1430
209	1260	1400	1540
196	1350	1500	1650

### Input Capacitor

To limit the voltage drop on the input supply caused by transient in-rush currents when the switch is turned on into a discharged load capacitor or a short-circuit; a capacitor needs to be placed between  $V_{IN}$  and GND. A 4.7  $\mu\text{F}$  ceramic capacitor,  $C_{IN}$ , must be placed close to the  $V_{IN}$  pin. A higher value of  $C_{IN}$  can be used to further reduce the voltage drop experienced as the switch is turned on into a large capacitive load.

### Output Capacitor

A 0.1  $\mu\text{F}$  capacitor  $C_{OUT}$ , should be placed between  $V_{OUT}$  and GND. This capacitor prevents parasitic board inductances from forcing  $V_{OUT}$  below GND when the switch turns-off.

### Power Dissipation

During normal operation as a switch, the power dissipated in the part depends upon the level at which the current limit is set. The maximum allowed setting for the current limit is 0.77 A and this results in a power dissipation of,

$$P = (I_{LIM})^2 \times R_{DS} = (0.77)^2 \times 0.12 = 71.148 \text{ mW} \quad (\text{eq. 2})$$

If the part goes into current limit the maximum power dissipation occurs when the output is shorted to ground. This is more power than the package can dissipate, but the thermal shutdown of the part activates to protect the part from damage due to excessive heating. A short on the output causes the part to operate in a constant-current state dissipating a worst case power of,

$$P(\text{max}) = V_{IN}(\text{max}) \times I_{LIM}(\text{max}) = 5.5 \times 0.77 = 4.235 \text{ W} \quad (\text{eq. 3})$$

This large amount of power activates the thermal shutdown and the part cycles in and out of thermal shutdown so long as the ON pin is active and the short is present.



## FPF2165R

### Board Layout

For best performance, all traces should be as short as possible. To be most effective, the input and output capacitors should be placed close to the device to minimize the effects that parasitic trace inductances may have on normal and short-circuit operation. Using wide traces for  $V_{IN}$ ,  $V_{OUT}$  and GND helps minimize parasitic electrical effects along with minimizing the case-to-ambient thermal impedance.

The middle pad (pin 7) should be connected to the GND plate of PCB for improving thermal performance of the load switch. An improper layout could result higher junction temperature and triggering the thermal shutdown protection feature. This concern applies when the switch is set at higher current limit value and an over-current condition occurs. In this case power dissipation of the switch ( $P_D = (V_{IN} - V_{OUT}) \times I_{LIM(max)}$ ) could exceed the maximum absolute power dissipation of 1.2 W.

# MECHANICAL CASE OUTLINE

## PACKAGE DIMENSIONS

ON Semiconductor®



WDFN6 2x2, 0.65P  
CASE 511CY  
ISSUE O

DATE 31 JUL 2016

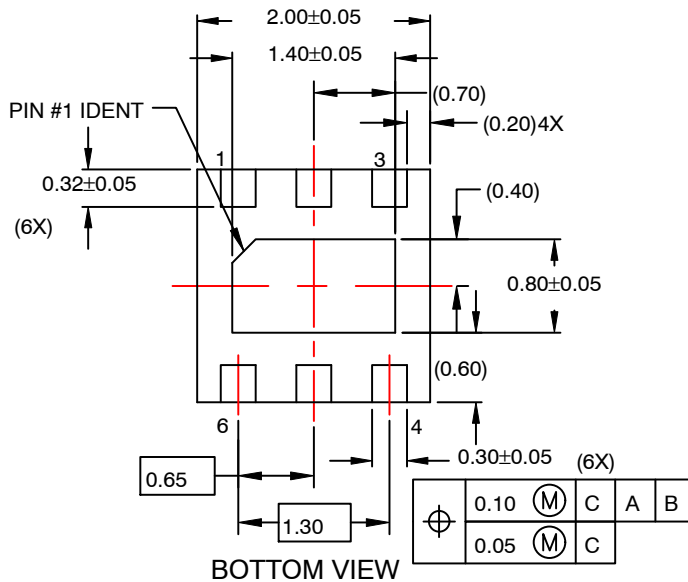
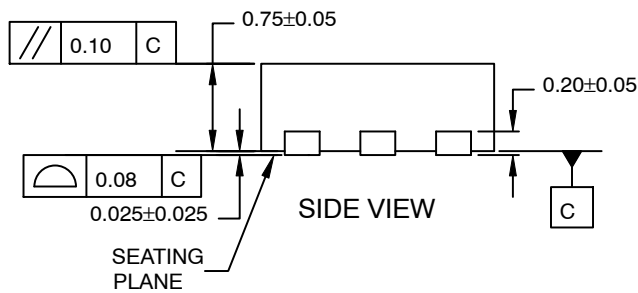
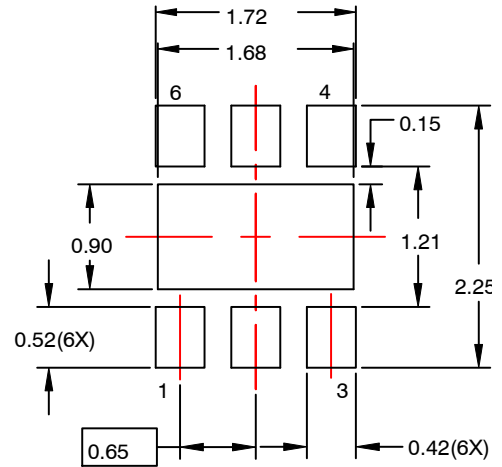
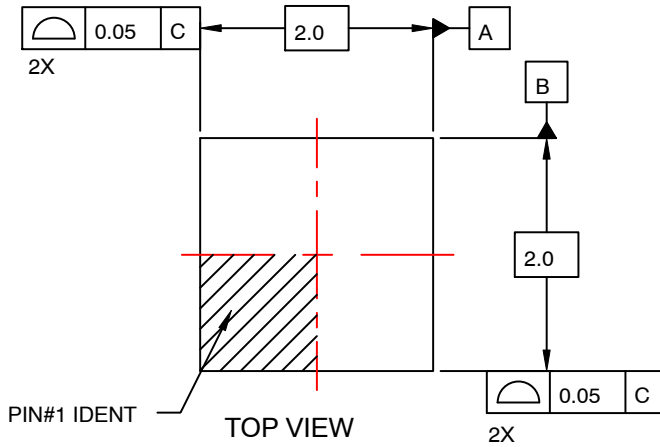

NOTES:

- A. PACKAGE DOES NOT FULLY CONFORM TO JEDEC MO-229 REGISTRATION
- B. DIMENSIONS ARE IN MILLIMETERS.
- C. DIMENSIONS AND TOLERANCES PER ASME Y14.5M, 2009.
- D. LAND PATTERN RECOMMENDATION IS EXISTING INDUSTRY LAND PATTERN.

<b>DOCUMENT NUMBER:</b>	<b>98AON13613G</b>	Electronic versions are uncontrolled except when accessed directly from the Document Repository. Printed versions are uncontrolled except when stamped "CONTROLLED COPY" in red.
<b>DESCRIPTION:</b>	<b>WDFN6 2X2, 0.65P</b>	<b>PAGE 1 OF 1</b>

ON Semiconductor and are trademarks of Semiconductor Components Industries, LLC dba ON Semiconductor or its subsidiaries in the United States and/or other countries. ON Semiconductor reserves the right to make changes without further notice to any products herein. ON Semiconductor makes no warranty, representation or guarantee regarding the suitability of its products for any particular purpose, nor does ON Semiconductor assume any liability arising out of the application or use of any product or circuit, and specifically disclaims any and all liability, including without limitation special, consequential or incidental damages. ON Semiconductor does not convey any license under its patent rights nor the rights of others.

**onsemi**, **Onsemi**, and other names, marks, and brands are registered and/or common law trademarks of Semiconductor Components Industries, LLC dba "**onsemi**" or its affiliates and/or subsidiaries in the United States and/or other countries. **onsemi** owns the rights to a number of patents, trademarks, copyrights, trade secrets, and other intellectual property. A listing of **onsemi**'s product/patent coverage may be accessed at [www.onsemi.com/site/pdf/Patent-Marking.pdf](http://www.onsemi.com/site/pdf/Patent-Marking.pdf). **onsemi** reserves the right to make changes at any time to any products or information herein, without notice. The information herein is provided "as-is" and **onsemi** makes no warranty, representation or guarantee regarding the accuracy of the information, product features, availability, functionality, or suitability of its products for any particular purpose, nor does **onsemi** assume any liability arising out of the application or use of any product or circuit, and specifically disclaims any and all liability, including without limitation special, consequential or incidental damages. Buyer is responsible for its products and applications using **onsemi** products, including compliance with all laws, regulations and safety requirements or standards, regardless of any support or applications information provided by **onsemi**. "Typical" parameters which may be provided in **onsemi** data sheets and/or specifications can and do vary in different applications and actual performance may vary over time. All operating parameters, including "Typicals" must be validated for each customer application by customer's technical experts. **onsemi** does not convey any license under any of its intellectual property rights nor the rights of others. **onsemi** products are not designed, intended, or authorized for use as a critical component in life support systems or any FDA Class 3 medical devices or medical devices with a same or similar classification in a foreign jurisdiction or any devices intended for implantation in the human body. Should Buyer purchase or use **onsemi** products for any such unintended or unauthorized application, Buyer shall indemnify and hold **onsemi** and its officers, employees, subsidiaries, affiliates, and distributors harmless against all claims, costs, damages, and expenses, and reasonable attorney fees arising out of, directly or indirectly, any claim of personal injury or death associated with such unintended or unauthorized use, even if such claim alleges that **onsemi** was negligent regarding the design or manufacture of the part. **onsemi** is an Equal Opportunity/Affirmative Action Employer. This literature is subject to all applicable copyright laws and is not for resale in any manner.

## PUBLICATION ORDERING INFORMATION

### LITERATURE FULFILLMENT:

Email Requests to: [orderlit@onsemi.com](mailto:orderlit@onsemi.com)

**onsemi Website:** [www.onsemi.com](http://www.onsemi.com)

### TECHNICAL SUPPORT

**North American Technical Support:**

Voice Mail: 1 800-282-9855 Toll Free USA/Canada

Phone: 011 421 33 790 2910

**Europe, Middle East and Africa Technical Support:**

Phone: 00421 33 790 2910

For additional information, please contact your local Sales Representative